

2010 RAV4

 **TOYOTA**
moving forward

US-RV09-2-B



RAV4. IT'S PROOF OF THE VALUE IN VERSATILITY.

There are lots of ways to describe all the features offered on RAV4. Whether it's our Base, Sport or Limited model, you'll find RAV4's got what you want, priced right. RAV4 can be equipped to seat up to seven one minute and haul bulky yard sale finds the next. It offers you the choice of fuel-efficient 4-cylinder or V6 engines, and 2WD or 4WD. Its safety features reassure you, yet it offers agility you'd hardly expect from an SUV. The 2010 Toyota RAV4.

Moving Forward.



Limited V6 shown in Classic Silver Metallic with available Extra Value Package #2.

OPTITRON GAUGES

To help reduce eye fatigue, amber-illuminated tri-dial Optitron gauges are standard along with twin tripmeters, an outside temperature gauge and Direct Tire Pressure Monitor System (TPMS).¹



DID YOU KNOW?

BP's Helio House is the first LEED certified gas station in America. Its features include solar panels that help power the pumps and a rain collector to help water the plants.

RAV4 BASE/ SPORT

There's nothing basic about RAV4 Base. Just look at what's standard: air conditioning, Optitron gauges, a tilt/telescopic steering wheel, cruise control and a 6-speaker audio system with an auxiliary audio jack for your MP3 player. RAV4 Sport has all that, plus a sport-tuned

suspension and color-keyed fender flares to give it a look and feel all its own. And both models come standard with a 179-hp 2.5-liter 4-cylinder engine with an EPA-estimated 28 highway mpg rating.^{2,3}

1. See footnote 31 in Packages section. 2. See footnote 14 in Packages section. 3. 2WD models.



US-RV09-6-B

RAV4 LIMITED

If you like to have all the bells and whistles, you'll love RAV4 Limited. Its leather-trimmed steering wheel integrates switches that let you control key features. Like what? Like an available 9-speaker JBL® audio system that includes a 6-disc in-dash CD changer, an XM Satellite Radio integrated receiver,¹ MP3/WMA playback capability and hands-free phone functionality via Bluetooth®² wireless technology. Whistle away.

A AVAILABLE TOUCH-SCREEN DVD NAVIGATION SYSTEM³

Need help finding your way across town or across the country? RAV4 Limited offers an available navigation system that maps out your route. For instance, just enter the name of a nearby restaurant, and, if listed in the database, the system will find it, and you're on your way. And XM NavTraffic^{®3,4} uses real-time updates of traffic congestion to plan your route. After all, who wants to be stuck in a traffic jam?

B SMART KEY SYSTEM⁵

RAV4 Limited comes standard with a Smart Key System. Like saying "open sesame," the way it works is magical. It senses your approach even if the key is in your pocket or purse. As soon as you touch the driver's door handle, it automatically unlocks. And when you climb into the driver's seat, Smart Key lets you start RAV4 via push-button ignition.

Limited 4WD interior shown in Ash with available Extra Value Package #2.

1. See footnote 20 in Packages section. 2. See footnote 21 in Packages section. 3. See footnote 22 in Packages section. 4. See footnote 18 in Packages section. 5. See footnote 32 in Packages section.

KNOW WHEN TO FOLD
RAV4 makes it easy for you to configure the space behind the driver's seat to the task at hand. The second row folds flat so you can make the most of RAV4's 73 cubic feet of cargo space!¹ Need more? Under-floor storage² lets you stash items out of sight.



1



2

SEATING VERSATILITY
RAV4's second-row seats split-fold 60/40 to create several ways for you to conveniently carry both passengers and cargo!¹ Or with a pull of the one-touch levers in the cargo area, RAV4's second row folds flat!²



3



4



5

Limited interior shown in Ash with available Extra Value Package #2 and accessory floor mats.



US-RV09-11-C



6↑ 7↓



US-RV09-8-B

7-PASSENGER SEATING
With its available 50/50 Split & Stow 3rd Row™ seats,^{3,4} RAV4 instantly becomes a 7-passenger SUV. From there, you can fold the entire third row or either half of the row flat into the floor.

Base interior shown in Ash with available 50/50 Split & Stow 3rd Row™ seats^{3,4} and Extra Value Package.

READY FOR WHAT'S NEXT.

RAV4 gives you the flexibility to respond to the fundamental question all SUV owners ask themselves: What am I doing next? Running the whole team to the game? Going solo to the home center? Picking up friends at the airport? Packing up the camping gear for a weekend road trip? Whatever it is, RAV4 is ready. With a versatile seating area designed to let you seat up to seven when equipped with the available third-row seats,^{3,4} Or with a spacious cargo area that opens wide and folds flat for easy loading.

1 73 CUBIC FEET OF CARGO CAPACITY¹

You'll be surprised by how much room RAV4 gives you to carry cargo and by how easy it is to fold the rear seats flat so you can make the most of all 73 cubic feet.

2 CARGO AREA UNDER-FLOOR STORAGE²

Hide your laptop and other valuables in this secret space under the floor.

3 ONE-TOUCH FOLD-FLAT SECOND-ROW SEATS²

With just one pull of the cargo area one-touch levers, the second row folds flat to form a surface ideal for loading gear.

4 SEAT FIVE, LEAVE ROOM FOR LUGGAGE

Keep the second row upright and RAV4 seats five yet still has lots of room in the rear cargo area for gear or groceries.

5 SPLIT-SECOND RESPONSE

RAV4's second row is remarkably versatile. It split-folds 60/40, for a variety of cargo- and passenger-carrying configurations. Or the entire row folds flat.

6 BACKUP CAMERA⁵

RAV4's available backup camera is a smart solution that helps ease the task of backing out of driveways or into parallel parking spaces.

7 MP3/WMA-COMPATIBLE AND XM SATELLITE RADIO⁶

No matter where you take your RAV4, your tunes can always travel with you. An auxiliary audio jack for MP3/WMA devices is located on the front of the center console. And the available integrated XM Satellite Radio receiver⁷ comes with a 90-day trial subscription, so you can enjoy 170 channels of crystal-clear digital channels right away.

1. See footnote 12 in Packages section. 2. Not available on vehicles equipped with 50/50 Split & Stow 3rd Row™ seats. 3. Available on Base and Limited models only. 4. See footnote 27 in Packages section. 5. See footnote 23 in Packages section. 6. See footnote 20 in Packages section. 7. Standard on Limited. Available on Base and Sport models.



US-RV09-14-A

iPod® accessory not included. iPod® is a registered trademark of Apple, Inc. All rights reserved.

OUTSIDE MIRRORS WITH TURN-SIGNAL INDICATORS¹

RAV4 signals your turning intentions clearly for nearby drivers to see. In addition to turn signals integrated into the headlamp housing, RAV4 has available sideview mirror-mounted turn signals.

US-RV09-17-A



US-RV09-16-B



US-RV09-18-B



ALL THAT GLITTERS IS SPORT

An available Sport Appearance Package² adds to RAV4's already sophisticated sense of style. The clean look of the rear – with its stainless steel exhaust tip and unique rear door with no spare tire – is your clue that this is no ordinary RAV4. Slide behind the wheel, grab hold of the chrome- and leather-accented shift knob and take command of the available Electronic On-Demand 4-wheel drive (4WD). Whether you're taking this special RAV4 out for an evening on the town, or headed out of town in search of adventure, be prepared for heads to turn your way.

1. Standard on Limited. Available on Sport models with Sport Appearance Package. 2. Not available on Sport V6 2WD model. 3. See footnote 36 in Packages section.

DID YOU KNOW?
For 2010, the Sport Appearance Package² is now available on 4-cylinder 2WD and 4WD Sport models.³

Sport 4WD shown in Magnetic Gray Metallic with available Sport Appearance Package² and Extra Value Package.

RAV4 ON THE MOVE

RAV4's size helps give it an agility you'll appreciate, whether you're parallel parking or powering up a mountain road. And its shape was honed in the wind tunnel to help enhance fuel efficiency. Available features like Electronic On-Demand 4-wheel drive (4WD), Hill Start Assist Control (HAC)^{1,2} and Downhill Assist Control (DAC)^{1,2} help optimize grip, while an available 269-hp V6 uses dual VVT-i to deliver an EPA-estimated highway rating of up to 26 mpg³ for V6 4WD models.



1. See footnote 9 in Packages section. 2. See footnote 10 in Packages section. 3. See footnote 14 in Packages section.

Limited V6 4WD shown in Classic Silver Metallic with available Extra Value Package #2.

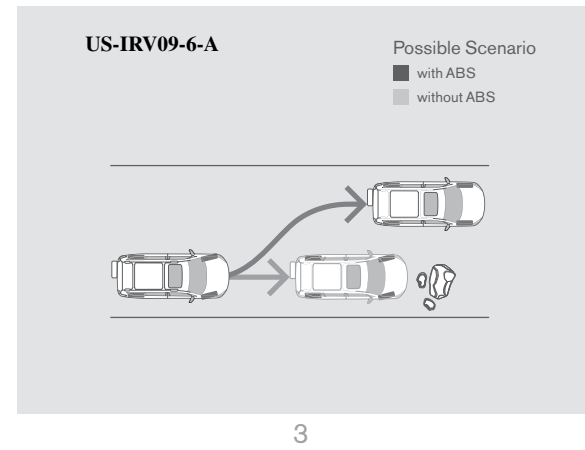
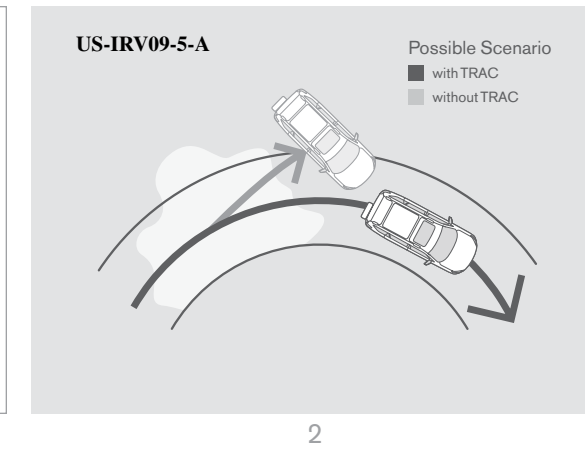
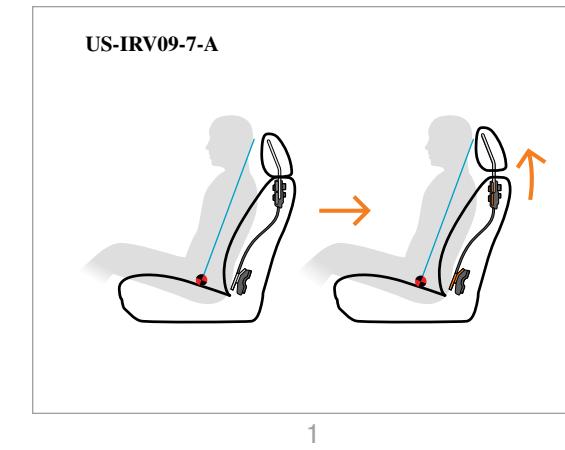
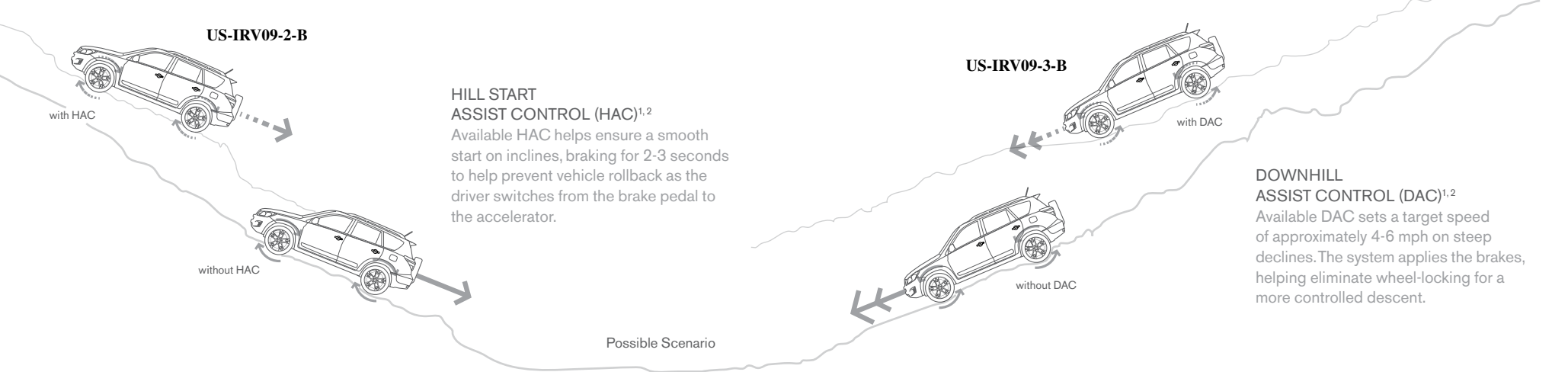

Available Electronic On-Demand 4WD **A** controls the distribution of torque between the front and rear wheels, allowing the vehicle to automatically switch seamlessly from front-wheel-drive **B** to 4WD mode. **C** The result is enhanced traction, control and fuel economy.

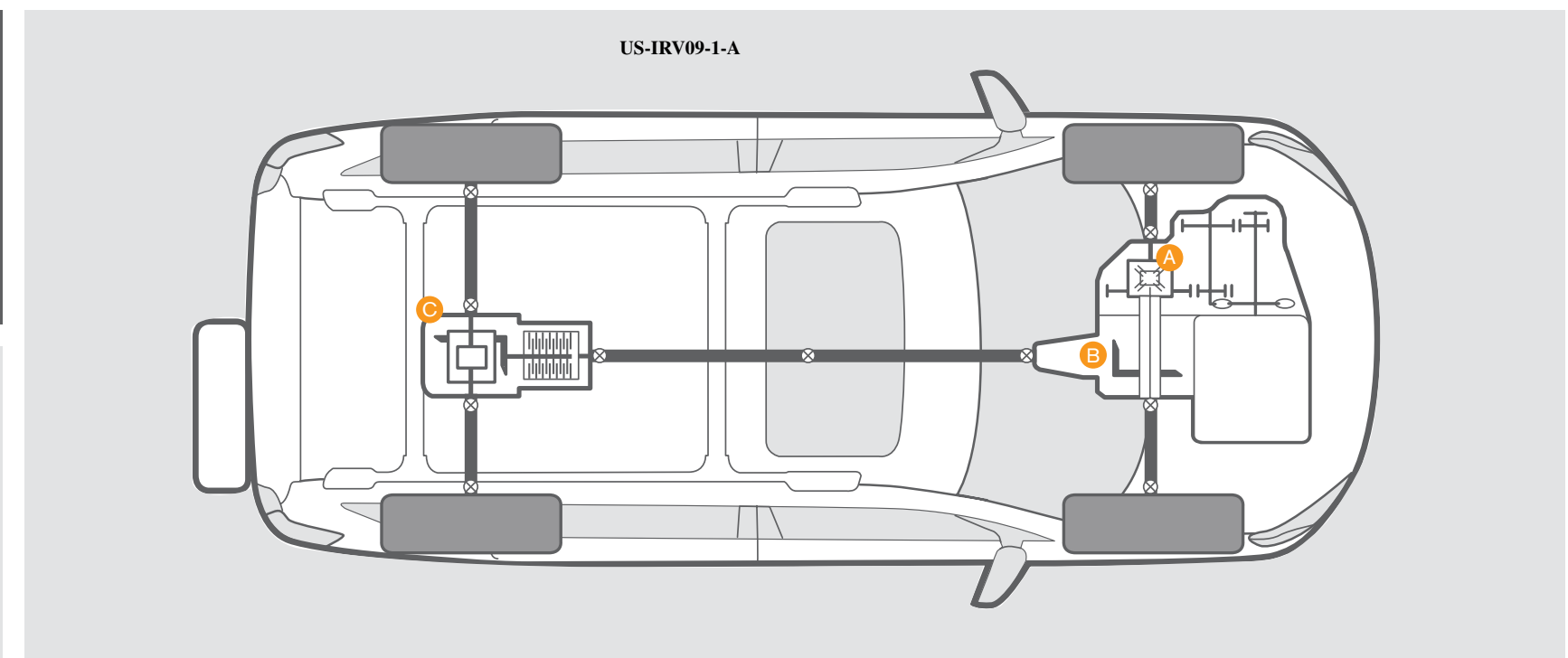
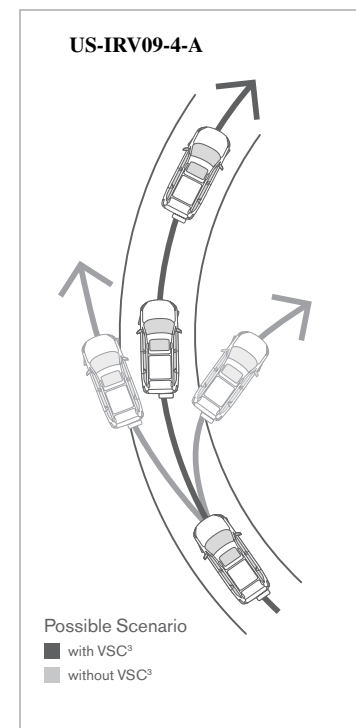

Photo not intended to replicate actual inflated airbags.



ADVANCED ENGINEERING

The advanced technologies available on RAV4 are designed to help give drivers a sophisticated set of tools to help take on whatever comes their way. Steep hills. Slippery slopes. Snow-covered streets. Rain-soaked roads. Yet as these technologies work their quiet magic, the complexities of how they do what they do are largely hidden from the driver. From the driver's perspective, using these tools is simple. Little more than a push of a button – if that – is required of the driver. And that's the beauty of Toyota engineering.

Don't let its size fool you – RAV4 is big on safety. Every 2010 RAV4 comes standard with the Star Safety System,[™] a set of technologies that includes Enhanced Vehicle Stability Control (VSC)³ with Traction Control (TRAC), Anti-lock Brake System (ABS) with Electronic Brake-force Distribution (EBD) and Brake Assist.⁴ RAV4's Advanced Airbag System⁵ includes both driver and front passenger airbags⁵ and is complemented by front seat-mounted side airbags as well as first- and second-row roll-sensing side curtain airbags.⁵

- 2 **TRACTION CONTROL (TRAC)**
If a wheel loses traction, TRAC limits engine output and/or applies the brake to the spinning wheel and transfers torque to the wheel that's still got traction.
- 3 **ANTI-LOCK BRAKE SYSTEM (ABS)**
ABS pulses brakes rapidly during hard braking to help keep the wheels from locking up and thus helps preserve steering control.
- 4 **ENHANCED VEHICLE STABILITY CONTROL (VSC)³**
To help improve control in situations that could cause a vehicle to slip sideways while cornering, RAV4 uses Enhanced VSC. It adjusts engine power, braking and steering assist torque to help the driver steer in the direction that provides the greatest control.

- 1 **ACTIVE FRONT HEADRESTS⁶**
In the event of certain rear-end collisions, a mechanism in the lumbar region of the front seats triggers the movement of the headrests up and forward to help position the headrests to better support the front occupants' heads.

1. See footnote 9 in Packages section. 2. See footnote 10 in Packages section. 3. See footnote 8 in Packages section. 4. See footnote 7 in Packages section. 5. See footnote 33 in Packages section. 6. See footnote 34 in Packages section.

COLOR



BLACK
Ash, Sand Beige or Dark Charcoal^{1, 2} interior



BLACK FOREST PEARL³
Ash¹, Sand Beige or Dark Charcoal^{1, 2} interior



PACIFIC BLUE METALLIC³
Ash, Sand Beige or Dark Charcoal^{1, 2} interior



PYRITE MICA⁴
Ash or Sand Beige interior



BARCELONA RED METALLIC
Ash, Sand Beige or Dark Charcoal^{1, 2} interior



SANDY BEACH METALLIC⁴
Sand Beige interior



MAGNETIC GRAY METALLIC^{1, 2}
Dark Charcoal interior



CLASSIC SILVER METALLIC
Ash or Dark Charcoal^{1, 2} interior



BLIZZARD PEARL^{2, 4, 5}
Ash or Sand Beige interior



SUPER WHITE^{1, 3}
Ash, Sand Beige or Dark Charcoal^{1, 2} interior

FABRIC/LEATHER



US-RV09-26-A

Base fabric in Ash



US-RV09-26-B

Base fabric in Sand Beige



US-RV06-38-B

Sport fabric in Dark Charcoal



US-RV06-39-F

Limited fabric in Ash



US-RV06-39-E

Limited fabric in Sand Beige



US-RV06-40-F

Sport available leather in Dark Charcoal



US-RV06-40-C

Limited available leather in Ash



US-RV06-40-G

Limited available leather in Sand Beige

WHEEL



US-RV06-41-B
RAV4 Base 4-cylinder standard 16-in. steel wheel and wheel cover⁹



US-RV06-42-B
RAV4 Base 4-cylinder available; Base V6 standard 17-in. 5-spoke styled steel wheel



US-RV09-30-A
RAV4 Base available 17-in. 5-spoke alloy wheel



US-RV06-44-C
Sport standard 18-in. 5-spoke alloy wheel



US-RV09-31-A
Limited standard 17-in. 6-spoke alloy wheel

WARRANTIES

Every Toyota Car, Truck and SUV is built to exceptional standards. And that's not idle boasting. We back it up with these Limited Warranty Coverages:

Basic: 36 months/36,000 miles (all components other than normal wear and maintenance items).

Powertrain: 60 months/60,000 miles (engine, transmission/transaxle, front-wheel drive, rear-wheel drive, seatbelts and airbags).

Rust-Through: 60 months/unlimited miles (corrosion perforation of sheet metal).

Emissions: Coverages vary under Federal and California regulations. Refer to applicable *Warranty and Maintenance Guide* for details.

Accessories: For accessories purchased at the time of the new vehicle purchase, the Toyota Accessory Warranty coverage is in effect for 36 months/36,000 miles from the vehicle's in-service date, which is the same coverage as the Toyota New Vehicle Limited Warranty.

For accessories purchased after the new vehicle purchase the coverage is 12 months, regardless of mileage, from the date the accessory was installed on the vehicle, or the remainder of any applicable new vehicle warranty, whichever provides greater coverage, with the exception of car covers. Car covers are warranted for 12 months from the date of purchase and do not assume any coverage under the Toyota New Vehicle Limited Warranty.

You may be eligible for transportation assistance if it's necessary that your vehicle be kept overnight for repairs covered under warranty. Please see your authorized Toyota dealership for further details.

For complete details about Toyota's warranties, please visit www.toyota.com, refer to the applicable *Warranty and Maintenance Guide* or see your Toyota dealer.

MECHANICAL/PERFORMANCE

	BASE	SPORT	LIMITED
Engine	2.5-liter DOHC 16-valve SFI dual VVT-i 4-cylinder; 179 hp @ 6000 rpm/172 lb.-ft. @ 4000 rpm 3.5-liter DOHC 24-valve SFI dual VVT-i V6; 269 hp @ 6200 rpm/246 lb.-ft. @ 4700 rpm	Standard Available	Standard Available
Emission rating: Ultra Low Emission Vehicle II (ULEV II)	Standard	Standard	Standard
Ignition	Electronic, with Toyota Direct Ignition (TDI)		
Transmission – 4-cylinder – V6	4-speed electronically controlled automatic overdrive (ECT) 5-speed electronically controlled automatic overdrive (ECT)		
Body construction	Unitized body		
Drivetrain	Front engine front-wheel drive or Electronic On-Demand 4-wheel drive (4WD)		
Suspension – Front – Rear	Independent MacPherson strut with stabilizer bar and hydraulic shock absorbers Double-wishbone coil-spring rear suspension with trailing arms and hydraulic shock absorbers and stabilizer bar (Sport model gets tuned shocks and springs)		
Steering	Electric power steering (EPS): power-assisted rack-and-pinion with electronic power-assist		
Turning circle diameter, curb to curb (ft.) (16-in. and 17-in. wheels/18-in. wheels)	34.8/36.8		
Brakes	Power-assisted ventilated front disc brakes and solid rear disc brakes with 4-wheel Anti-lock Brake System (ABS), Electronic Brake-force Distribution (EBD) and Brake Assist ⁷		
Vehicle Stability Control (VSC) ⁸ with Traction Control (TRAC)	Standard	Standard	Standard
Hill Start Assist Control (HAC) ⁹	Available ¹⁰	Available ¹⁰	Available ¹⁰
Downhill Assist Control (DAC) ⁹	Available ¹⁰	Available ¹⁰	Available ¹⁰
EXTERIOR DIMENSIONS (in.)			
Overall height (without/with roof rails with available third-row seats)	66.3/68.7 66.5/69.1	66.3/68.7 NA	66.3/68.7 66.5/69.1
Overall width	71.5	73.0 (with overfender)	73.0 (with overfender)
Overall length	181.9	181.9 (178.7 with Sport Appearance Package)	181.9
Wheelbase	104.7	104.7	104.7
Track (front/rear)	61.4/61.4	61.4/61.4 (V6: 61.8/61.8)	61.4/61.4
INTERIOR DIMENSIONS front/middle/rear (in.)			
Head room without moonroof with moonroof	40.8/39.7/37.2 N/A	40.8/39.7/NA 39.5/39.7/NA	40.8/39.7/37.2 39.5/39.7/37.2
Shoulder room	57.1/55.3/52.6	57.1/55.3/NA	57.1/55.3/52.6
Hip room	53.8/52.4/43.3	53.8/52.4/NA	53.8/52.4/43.3
Leg room	41.8/38.3/30.0	41.8/38.3/NA	41.8/38.3/30.0
Seating capacity (standard/with available third-row seats)	5/7	5/NA	5/7
OFF-HIGHWAY			
Approach/departure angle (degrees)	29/25	29/25	29/25
Ground clearance (in.)	7.5	7.5	7.5
WEIGHTS AND CAPACITIES			
Curb weight (lb.) (2WD/4WD) – 4-cylinder models – V6 models	3360/3494 3529/3670	3435/3569 3560/3699	3439/3576 3560/3699
Gross Vehicle Weight Rating – (GVWR) (lb.) (2WD/4WD)			
4-cylinder models with third-row seats	4430/4535 4730/4865	4430/4535 NA	4430/4535 4730/4865
V6 models with third-row seats	4600/4720 4895/5015	4600/4720 NA	4600/4720 4895/5015
Towing capacity ¹¹ (lb.)			
4-cylinder models (standard)	1500	1500	1500
V6 models (standard)/with Tow Prep Package (V6 only)	2000/3500	2000/3500	2000/3500
Cargo volume ¹² (cu. ft.) front/middle/rear seats – 2 rows – 3 rows	73.0/36.4/NA 73.0/37.2/12.3	73.0/36.4/NA NA	73.0/36.4/NA 73.0/37.2/12.3
Fuel tank (gal.)	15.9	15.9	15.9
TIRES			
Size – Standard (4-cylinder/V6) – Available (4-cylinder)	P215/70R16/ P225/65R17 P225/65R17	P235/55R18 NA	P225/65R17 NA
Type	All-Season steel-belted radial blackwalls		
Spare	Full-size	Full-size ¹³	Full-size
MILEAGE ESTIMATES mpg city/highway¹⁴			
4-cylinder – 2WD – 4WD	22/28 21/27	22/28 21/27	22/28 21/27
V6 – 2WD – 4WD	19/27 19/26	19/27 19/26	19/27 19/26

EXTERIOR	BASE	SPORT	LIMITED
Aerodynamic multi-reflector halogen headlamps with auto-off feature	S	–	–
Aerodynamic multi-reflector halogen headlamps with blackout sport trim and auto-off feature	–	S	–
Aerodynamic multi-reflector halogen headlamps with auto on/off feature	–	O	S
LED (light-emitting diode) for tail and stop lamps	S	S	S
Integrated fog lamps	–	S	S
Automatic Limited-Slip Differential (Auto LSD) (2WD models)	S	S	S
Electronic On-Demand 4WD with 4WD manual lock switch	O ¹⁶	O ¹⁶	O ¹⁶
Hill Start Assist Control (HAC) ⁹	O ¹⁰	O ¹⁰	O ¹⁰
Downhill Assist Control (DAC) ⁹	O ¹⁰	O ¹⁰	O ¹⁰
Sport-tuned suspension (springs and shock absorbers)	–	S	–
16-in. steel wheels and wheel covers with P215/70R16 tires and full-size spare tire on 16-in. steel wheel	S ⁶	–	–
17-in. 5-spoke styled steel wheels with P225/65R17 tires and full-size spare tire on 17-in. steel wheel	O/P ¹⁷	–	–
17-in. 5-spoke alloy wheels with P225/65R17 tires and full-size spare tire on 17-in. steel wheel	O	–	–
17-in. 6-spoke alloy wheels with P225/65R17 tires and full-size spare tire on 17-in. steel wheel	–	–	S
18-in. 5-spoke alloy wheels with P235/55R18 tires and full-size spare tire on 18-in. alloy wheel ¹³	–	S	–
Side-opening rear door with hold-open feature	S	S	S
Roof-mounted antenna with XM ¹⁸ antenna and prepwire	S	S	S

INTERIOR

CFC-free air conditioning with air filtration	S	S	–
CFC-free dual zone automatic air conditioning with air filtration, micro dust/pollen removal capability and information display	–	–	S
AM/FM CD player with MP3/WMA playback capability, satellite radio capability ¹⁸ and six speakers	S	S	–
AM/FM 6-disc in-dash CD changer with integrated XM Satellite Radio receiver ²⁰ (includes 90-day trial subscription), MP3/WMA playback capability and six speakers	O	O/P	S
JBL® AM/FM 6-disc in-dash CD changer with integrated XM Satellite Radio receiver ²⁰ (includes 90-day trial subscription), MP3/WMA playback capability, hands-free phone capability via Bluetooth ^{®21} with steering wheel-mounted hands-free controls and nine speakers (includes subwoofer)	–	–	O/P
Touch-screen DVD navigation system ²² with AM/FM CD player, XM Satellite Radio capability ¹⁸ with NavTraffic® capability ²² (requires XM receiver and XM subscription), MP3/WMA playback capability and six speakers	–	O	O/P
Integrated backup camera ²³ linked to an electrochromic mirror with integrated backup camera ²³ monitor	O ²⁴	O	O
Auxiliary audio jack on center console	S	S	S
Tilt/telescopic steering wheel with instrument panel display control	S	S	S
Urethane steering wheel	S	S	–
Leather-wrapped steering wheel with audio controls	–	–	S
Leather-wrapped shift knob with metallic inlay	–	–	S
Fabric-trimmed 6-way adjustable driver's seat with height adjustment and seatback pockets	S	S	S
Fabric-trimmed 8-way adjustable power driver's seat with power lumbar support, height adjustment and seatback pocket	–	–	O
Fabric-trimmed 4-way manual adjustable front passenger seat with seatback pocket	S	S	S
Fabric-trimmed 60/40 split, reclining, fold-flat second-row seats with slide-forward capability, height-adjustable headrests and center armrest	S	S	S
Fabric-trimmed 50/50 Split & Stow 3rd Row™ seats with fold-flat-into-floor capability and height-adjustable headrests ²⁵	O ^{26, 27}	–	O ²⁷

SAFETY AND CONVENIENCE

 Star Safety System™ – includes Enhanced Vehicle Stability Control (VSC) ⁸ with Traction Control (TRAC), Anti-lock Brake System (ABS) with Electronic Brake-force Distribution (EBD) and Brake Assist ⁷	S	S	S
Direct Tire Pressure Monitor System (TPMS) ³¹	S	S	S
Driver and front passenger Advanced Airbag System ³³	S	S	S
Driver and front passenger seat-mounted side airbags and front- and second-row roll-sensing side curtain airbags (RSCA) ³³	S	S	S
Active headrests for driver and front passenger seats ³⁴	S	S	S
3-point seatbelts in all seating positions, with adjustable front seatbelt anchors	S	S	S

BASE	SPORT	LIMITED
Black door handles	S	–
Color-keyed door handles	–	S
Color-keyed back door handle	S	S
Black grille	S	S
Chrome-accented grille	–	–
Color-keyed front and rear bumpers	S	S
Black foldable power outside mirrors	S	S
Color-keyed foldable power heated outside mirrors with turn-signal indicators	–	P ¹⁹
Color-keyed full-size combination hard/soft outside spare tire cover	S	S ¹³
Color-keyed full-size hard-shell outside spare tire cover	–	–
Color-keyed fender flares	–	S
Color-keyed rear spoiler with center high-mount stop lamp (CHMSL)	S	S
Washer-linked variable intermittent windshield wiper	S	S
Power tilt/slide moonroof with sunshade	–	O/P
High Solar Energy-Absorbing (HSEA) glass	S	S
Privacy glass on rear side, quarter and rear door windows	O/P	S
Rear window electric defogger with timer and intermittent wiper	S	S
Rear-step bumper protector	S	S
Black roof rails and cross bars	O/P	O/P
Tow Prep Package ¹¹ (V6 models only) with 3500-lb. towing capacity – includes upgraded radiator, fan coupling and alternator	O	O

Premium Package – includes leather seating surfaces and 8-way adjustable power driver's seat with power lumbar support	–	O	O/P ²⁸
Cruise control with brake deceleration feature	S	S	S
120V AC power outlet	–	–	P ²⁹
Driver and front passenger heated seats	–	O ³⁰	O ³⁰
Amber-illuminated tri-dial Optitron cluster with speedometer, tachometer and fuel gauge meters; LCD odometer with twin tripmeters; and seatbelt disconnect, airbag, door-ajar, battery, oil pressure, brake, VSC-off, ⁸ Traction Control-off (TRAC), ABS, Direct Tire Pressure Monitor System (TPMS) ³¹ check engine, scheduled maintenance indicator and low-fuel level warning lights	S	S	S
Power windows with driver auto up/down with jam protection and door locks	S	S	S
Tonneau cover	O ²⁸	O	S ²⁸
Cargo area second-row-seat one-touch fold-flat levers	S ²⁸	S	S ²⁸
Remote keyless entry system	S	S	–
Smart Key System ³² with Push Button Start and remote illuminated entry	–	–	S
Instrument panel-mounted display with outside temperature, instantaneous and average fuel economy functions	S	S	S
Digital clock and gated shifter	S	S	S
Multi-function center console with two illuminated front cup holders, cell phone storage pocket, covered console door with upper tray and lower-console storage box	S	S	S
Interior footwell lighting	–	–	S
Dual glove boxes with one-push open/close on upper glove box	S	S	S
10 cup/bottle holders, two with storage pockets in wheel housing in cargo area	S	S	S
Door panels with integrated speakers, storage pocket and bottle holder	S	S	S
Illuminated entry system (key illumination, interior light, and front personal light)	S	S	S
Two front and one cargo area 12V auxiliary power outlets	S	S	S
Dual sun visors with vanity mirror, sliding extensions, and roof-mounted vanity light	S	S	S
Rear deck storage including water-repellent foldable deck board for concealed cargo under the floor	S ²⁸	S	S ²⁸

Emergency Locking Retractor (ELR) on driver's seatbelt and Automatic/Emergency Locking Retractors (ALR/ELR) on passenger seatbelts	S	S	S
Front ventilated disc/solid rear disc brakes	S	S	S
Driver and front passenger seatbelt warning system	S	S	S
Jam protection for driver-side auto up/down power window	S	S	S
Side-impact door beams	S	S	S
Child-protector rear door locks	S	S	S
Center high-mount stop lamp (CHMSL)	S	S	S
Child Restraint System (CRS) top tether anchors for all rear seating positions	S	S	S

SAFETY AND CONVENIENCE (continued)

BASE	SPORT	LIMITED
Second-row LATCH Child Restraint System (CRS) anchors for outboard rear seating positions	S	S
Daytime Running Lights (DRL)	O/P	O/P
Front energy-absorbing crumple zone	S	S

OPTIONS¹⁵

17-in. 5-spoke styled steel wheels with P225/65R17 tires and full-size spare tire on 17-in. steel wheel	O/P ¹⁷	–	–
17-in. 5-spoke alloy wheels with P225/65R17 tires and full-size spare tire on 17-in. steel wheel	O	–	–
AM/FM 6-disc in-dash CD changer with integrated XM Satellite Radio receiver ²⁰ (includes 90-day trial subscription), MP3/WMA playback capability and six speakers	O	O/P	S
JBL® AM/FM 6-disc in-dash CD changer with integrated XM Satellite Radio receiver ²⁰ (includes 90-day trial subscription), MP3/WMA playback capability, hands-free phone capability via Bluetooth ^{®21} with steering wheel-mounted hands-free controls and nine speakers (includes subwoofer)	–	–	O/P
Touch-screen DVD navigation system ²² with AM/FM CD player, XM Satellite Radio capability ¹⁸ with NavTraffic® capability ²² (requires XM receiver and XM subscription), MP3/WMA playback capability and six speakers	–	O	O/P

PACKAGES¹⁵

BASE Extra Value Package (4-cylinder models only) – includes 17-in. 5-spoke styled steel wheels with P225/65R17 tires and full-size spare tire on 17-in. steel wheel, Daytime Running Lights (DRL), black roof rails and cross bars, and rear privacy glass (on rear side, quarter and rear door window)			
---	--	--	--

SPORT

Extra Value Package – includes Daytime Running Lights (DRL), black roof rails and cross bars, power tilt/slide moonroof with sunshade, AM/FM 6-disc in-dash CD changer with integrated XM Satellite Radio receiver²⁰ (includes 90-day trial subscription), MP3/WMA playback capability and six speakers

Sport Appearance Package³⁶ (not available on V6 2WD model) – includes unique rear door with chrome accents, four run-flat tires, unique RAV4 and Sport badging, stainless steel exhaust tip, color-keyed foldable power heated outside mirrors with turn-signal indicators, chrome-accented shift knob with leather insert, chrome interior door handles, parking

LIMITED

Extra Value Package #1 – includes Daytime Running Lights (DRL), power tilt/slide moonroof with sunshade, JBL® AM/FM 6-disc in-dash CD changer with integrated XM Satellite Radio receiver²⁰ (includes 90-day trial subscription), MP3/WMA playback capability, hands-free phone capability via Bluetooth^{®21} with steering wheel-mounted hands-free controls and nine speakers (includes subwoofer) and Premium Package²⁸ (includes leather seating surfaces, 8-way adjustable power driver's seat with power lumbar support, driver and front passenger heated seats and 120V AC power outlet)

Extra Value Package #2 – includes Daytime Running Lights (DRL), power tilt/slide moonroof with sunshade, touch-screen DVD navigation system²² with AM/FM CD player, XM Satellite Radio capability¹⁸ with NavTraffic® capability²²

BASE	SPORT	LIMITED
Soft energy-dissipating interior trim	S	S
Engine immobilizer ³⁵	S	S
Collapsible steering column	S	S

Fabric-trimmed 50/50 Split & Stow 3rd Row™ seats with fold-flat-into-floor capability and height-adjustable headrests ^{25, 26, 27}	O	–	O
Privacy glass on rear side, quarter and rear door windows	O/P	S	S
Daytime Running Lights (DRL)	O/P	O/P	O/P
Integrated backup camera ²³ linked to an electrochromic mirror with integrated backup camera ²³ monitor	O ²⁴	O	O
Auto on/off headlamps	–	O	S
Power tilt/slide moonroof with sunshade	–	O/P	O/P
Tonneau cover	O ²⁸	O	S ²⁸
Black roof rails and cross bars	O/P	O/P	S

S = Standard **O = Optional** **P = Available only as part of a package.** **– = Not available**

BASE Extra Value Package (V6 models only) – includes Daytime Running Lights (DRL), black roof rails and cross bars, and rear privacy glass (on rear side, quarter and rear door window)			
Tow Prep Package ¹¹ (V6 models only) with 3500-lb. towing capacity – includes upgraded radiator, fan coupling and alternator			

brake tip and vent trim, unique doorsill covers and rear bumper protector (deletes four standard tires, spare tire, spare tire cover from rear of vehicle and black rear bumper step protector)

Premium Package – includes leather seating surfaces, 8-way adjustable power driver's seat with power lumbar support and driver and front passenger heated seats

Tow Prep Package¹¹ (V6 models only) with 3500-lb. towing capacity – includes upgraded radiator, fan coupling and alternator

(requires XM receiver and XM subscription), MP3/WMA playback capability and six speakers and Premium Package²⁸ (includes leather seating surfaces, 8-way adjustable power driver's seat with power lumbar support, driver and front passenger heated seats and 120V AC power outlet)

Premium Package²⁸ – includes leather seating surfaces, 8-way adjustable power driver's seat with power lumbar support, driver and front passenger heated seats and 120V AC power outlet

Tow Prep Package¹¹ (V6 models only) with 3500-lb. towing capacity – includes upgraded radiator, fan coupling and alternator

1. Not available on Limited. 2. Not available on Base. 3. Not available with Sport Appearance Package. 4. Not available on Sport. 5. Extra-cost color. 6. Standard on 4-cylinder models, not available with 50/50 Split & Stow 3rd Row™ seats. 7. Brake Assist is designed to help the driver take full advantage of the benefits of ABS. It is not a substitute for safe driving practices. Braking effectiveness also depends on proper brake-system maintenance and tire and road conditions. 8. Vehicle Stability Control (VSC) is an electronic system designed to help the driver maintain vehicle control under adverse conditions. It is not a substitute for safe driving practices. Factors including speed, road conditions and driver steering input can all affect whether VSC will be effective in preventing a loss of control. Please see your *Owner's Manual* for further details. 9. Downhill Assist Control (DAC) is designed to help the driver maintain vehicle control and speed on steep, downhill descents. Hill Start Assist Control (HAC) is designed to help minimize backward rolling on steep ascents. Neither system is a substitute for safe driving judgment and practices. Factors including speed, grade, surface conditions and driver input can all affect whether DAC and HAC will be effective in preventing a loss of control. Please see your *Owner's Manual* for further details. 10. Standard on models equipped with V6 engine or 4-cylinder model equipped with 50/50 Split & Stow 3rd Row™ seats. 11. Before towing, confirm your vehicle and trailer are compatible, hooked up and loaded properly and that you have any necessary additional equipment. Do not exceed any Weight Ratings and follow all instructions in your *Owner's Manual*. The maximum you can tow depends on the total weight of any cargo, occupants and available equipment. 12. Cargo and load capacity limited by weight and distribution. 13. The Sport Appearance Package replaces standard tires with run-flat tires and does not include a spare tire or spare tire cover. 14. 2010 EPA-estimated mileage. Actual mileage will vary. 15. Toyota strives to build vehicles to match customer interest and thus they typically are built with popular options and option packages. Not all options/packages are available separately and some may not be available in all regions of the country. See toyota.com for information about options/packages commonly available in your area. If you would prefer a vehicle with no or different options, contact your dealer to check for current availability or the possibility of placing a special order. 16. 4-wheel-drive (4WD) models only. Automatically disengages at speeds above 25 mph. 17. Standard on V6 models, available on 4-cylinder. 18. Satellite radio requires XM-compatible receiver and monthly service fee. Vehicles without a factory-installed radio receiver require hardware purchase and installation. See your Toyota dealer for further details. Reception of the satellite signal may vary depending on location. All fees and programming subject to change. Subscriptions subject to the terms and conditions available at www.xmradio.com. Available only in the 48 contiguous United States. 19. Available in Sport Appearance Package. V6 4WD and 4-cylinder 2WD and 4WD models only. 20. Satellite radio requires an XM monthly service fee. See your Toyota dealer for further details. Reception of the satellite signal may vary depending on location. All fees and programming subject to change. Subscriptions subject to the terms and conditions available at www.xmradio.com. Available only in the 48 contiguous United States. 21. The Bluetooth® technology phones listed on toyota.com have been tested for compatibility with Toyota vehicles. Performance will vary based on phone software version, coverage and your wireless carrier. Phones are warranted by their manufacturer, not Toyota. 22. The navigation system is designed to assist in locating an address or point of interest. XM NavTraffic® requires a monthly service fee and hardware and is designed to provide real-time traffic or alternative routes of travel. Discrepancies may be encountered between the system and your actual location. Road system changes may affect the accuracy of the information provided. Rely on your common sense to decide whether to follow a specified route. Detailed coverage not available in every city or roadway. Periodic navigation updates available at an additional cost. See your *Navigation System Owner's Manual* for further details. 23. The backup camera does not provide a comprehensive view of the rear area of the vehicle. You should also look around outside your vehicle and use your mirrors to confirm rearward clearance. Cold weather will limit effectiveness and view may become cloudy. 24. Requires privacy glass or Base Extra Value Package. 25. Second-row seat adds a walk-in system on passenger side. 26. Requires 17-in. styled steel wheels with P225/65R17 tires or 17-in. alloy wheels with P225/65R17 tires. 27. Not available with tonneau cover. Deletes rear deck cover and cargo area second-row-seat one-touch fold-flat levers. 28. Not available with 50/50 Split & Stow 3rd Row™ seats. 29. Included with Premium Package or with optional power driver's seat. 30. Requires Premium Package. 31. The Toyota Tire Pressure Monitor alerts the driver when tire pressure is critically low. For optimal tire wear and performance, tire pressure should be checked regularly with a gauge; do not rely solely on the monitor system. See your *Owner's Manual* for details. 32. The Smart Key System may interfere with some pacemakers or cardiac defibrillators. If you have one of these medical devices, please talk to your doctor to see if you should deactivate this system. 33. All the airbag (AB) systems are Supplemental Restraint Systems. All ABs (if installed) are designed to inflate only under certain conditions and in certain types of severe collisions: frontal and knee ABs typically inflate in frontal collisions; side and side curtain ABs in side collisions; Roll-Sensing Curtain ABs at a severe tilt degree, roll or lateral G-force. In all other accidents, the ABs will not inflate. To decrease the risk of injury from an inflating AB, always wear seatbelts, sit upright in the middle of the seat as far back as possible and do not lean against the door. Do not put objects in front of an AB or around the seatback. Do not use a rearward-facing child seat in any front passenger seat. The force of an inflating AB may cause serious injury or death. See your *Owner's Manual* for further information/warnings. 34. Active headrests can help reduce the extent of whiplash in certain types of rear-end collisions. 35. The engine immobilizer is a state-of-the-art anti-theft system. When you insert your key into the ignition switch, the key transmits an electronic code to the vehicle. The engine will only start if the code in the transponder chip inside the key matches the code in the vehicle's immobilizer. Because the transponder chip is embedded in the key, it can be costly to replace. If you lose a key, your Toyota dealer can help, or you can find a qualified independent locksmith to replace your key or perform high-security key services at www.aloa.org. 36. 4-cylinder Sport models equipped with Sport Appearance Package will become available early 2010.

The RAV4 is designed to meet most off-road driving requirements. Abusive use may result in bodily harm or damage. Toyota encourages responsible operation to protect you, your vehicle and the environment. Seatbelts should be worn at all times. Please do not allow passengers to ride in the cargo area. Towing hitch receivers/ball mount kits are not intended to provide crash protection. For details on vehicle

TOYOTA MOBILITY For Toyota Mobility program details, go to www.toyota.com/mobility or call the Toyota Customer Assistance Center at 1-800-331-4331

specifications, standard features and available equipment in your area, contact your Toyota dealer. A vehicle with particular equipment may not be available at the dealership. Ask your Toyota dealer to help locate a specifically equipped vehicle. All information presented herein is based on data available at the time of printing, is subject to change without notice and pertains specifically to mainland U.S.A. vehicles only.





Our eyes are always on the road ahead. Striving to find ways to help you be safe. Go farther on a tank of gas. To help the earth go further on its limited resources. Moving Forward is embedded in our DNA. It's shared by our dealers, and ultimately inspired by our customers. **toyota.com 1-800-GO-TOYOTA**

FOCUS ON SUSTAINABILITY

Toyota encourages their printing partners to embrace environmentally responsible business practices, including compliance with nationally recognized certification requirements. These partners adhere to either FSC (Forest Stewardship Council) or SFI (Sustainable Forestry Initiative) guidelines that ensure Toyota brochures use paper from well-managed forests through a chain of custody – from the tree to the paper mill, from the paper mill to the printer, then, from the printer to Toyota.

100% of the electricity purchased by one of Toyota's print partners is generated by renewable wind energy. Another print partner installed solar panels and expects their company's energy demands to decrease by 30% and reduce their carbon emissions by 630 tons per year. This brochure is printed on Sappi's Opus Gloss paper. 100% of the electricity used to manufacture this paper was generated by Green-e® certified renewable energy sources. Opus Gloss uses 10% post-consumer recovered fiber and is FSC certified, sourcing fiber from sustainably managed forests.

©2009 Toyota Motor Sales, U.S.A., Inc. PT0-176 (8/09) 00617-10RAV Litho in U.S.A.



VENZA



AVALON



CAMRY



CAMRY SOLARA



PRIUS



COROLLA



YARIS



MATRIX



TUNDRA



CAMRY HYBRID



TACOMA



LAND CRUISER



4RUNNER



RAV4



HIGHLANDER HYBRID



FJ CRUISER



SEQUOIA



HIGHLANDER



SIENNA



Hybrid Synergy Drive[®], powering the Prius, Camry Hybrid and Highlander Hybrid, combines a clean-burning gas engine with an efficient electric motor to deliver excellent fuel economy, low emissions and performance.