

2012 **Golf**



Das Auto.





TDI 2-door with Sunroof and Navigation shown in Reflex Silver Metallic

Better engineering for you.

German engineering isn't just about creating a faster car. Or a tighter ride. Or even the most fuel-efficient engine. We're not merely designing the sleekest silhouette. Or the roomiest cargo space. Or the most breathtaking sunroof. And even though we place safety at the top of our list, we're not in this solely to get recognition for our success. Or to break records. Or to add extra safety features just to be safe. At Volkswagen, we're about all of these things happening together, beautifully and precisely, to create a car that's actually fun to drive. Because we're not just making any car, we're making your car. That's the power of German engineering.

The Golf

Loved the world over.

There are hundreds of reasons to love the Golf. Its classic design, unrivaled versatility, and smile-inducing available TDI® Clean Diesel engine are just a few of the features that make it one of the most awarded cars around. So while we were flattered when the Golf was named one of *Car and Driver's* "10Best Cars for 2011," especially after Kelley Blue Book's kbb.com named the Golf TDI one of their Top 10 Green Cars of 2011,* we can't say we were surprised. Because for 37 years customers around the world have been making the Golf one of the most popular compact cars on the road. And while the awards panelists only have the privilege of driving the Golf for a few days, our customers get to drive it for years. And the fact that they keep coming back for more year after year is what keeps us innovating. The awards, well, they're just more proof that we're doing something right.



When you buy any new VW, you get three years or 36,000 miles of no-charge scheduled Carefree Maintenance.** That's right, no extra charge. If you'd like, stop by in the first 90 days, or 6,000 miles, for your courtesy vehicle check. Then come by every year, or 10,000 miles, for your remaining scheduled maintenance checks. If only everything in life could be this carefree.

*For more information about the 2011 Top 10 Green Cars from Kelley Blue Book's kbb.com, visit www.kbb.com. Kelley Blue Book is a registered trademark of Kelley Blue Book Co., Inc. **The Volkswagen Carefree Maintenance Program covers the vehicle's scheduled maintenance for three years or 36,000 miles, whichever comes first. Coverage during the term of the new vehicle limited warranty at no additional charge. Some limitations apply. See dealer or vehicle maintenance program booklet for details.



TDI 2-door shown with Sunroof and Navigation in Shark Blue Metallic

TDI Clean Diesel

TDI Clean Diesel

Fun: 1. Compromise: 0.

140 horsepower

236 lbs/ft torque

Mileage

42 highway miles per gallon*

Travel

609 miles per tank*

90% fewer sooty emissions compared to previous diesel engines

95% less sulfur content in the ultra-low-sulfur diesel fuel

TDI Clean Diesel. You may not know that the T in TDI stands for turbo, but you'll see why when you get behind the wheel. It's the perfect union of power, performance, and fuel efficiency that delivers 140 hp and 236 lbs/ft torque for exceptional acceleration off the line, all while getting up to 42 highway mpg. That's up to 609 miles on one tank.* Plus, the TDI Clean Diesel engine produces 90 percent fewer sooty emissions than previous diesel engines. That's what we like to call a win-win-win situation.

Competitive range comparison

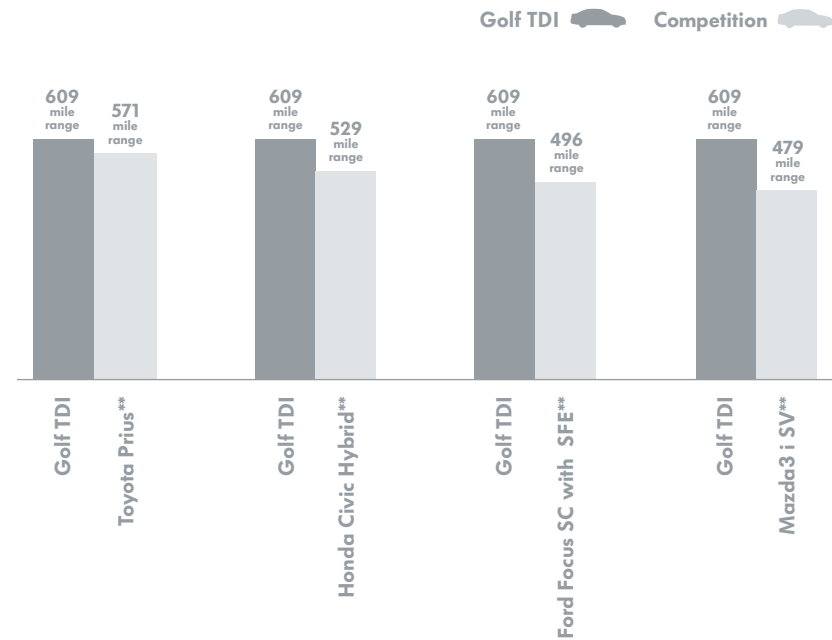

*2011 2.0L TDI Clean Diesel, DSG automatic: 30 city/42 highway mpg. Range based on 42 highway mpg EPA estimate and a 14.5-gallon tank. EPA estimates. Your mileage will vary. **Comparisons based on manufacturers' published data. 2011 1.8L Toyota Prius, ECVT transmission: 51 city/48 highway mpg. Range based on 48 highway mpg EPA estimate and a 11.9-gallon tank. 2011 1.4L Honda Civic Hybrid, CVT transmission: 40 city/43 highway mpg. Range based on 43 highway mpg EPA estimate and a 12.3-gallon tank. 2011 2.0L Ford Focus SE with SFE Package, automatic transmission: 28 city/40 highway mpg. Range based on 40 highway mpg EPA estimate and a 12.4-gallon tank. 2011 2.0L Mazda3 i SV, manual transmission: 25 city/33 highway mpg. Range based on 33 highway mpg EPA estimate and a 14.5-gallon tank. All fuel economy values are EPA estimates. Your mileage will vary.

TDI 4-door shown in Blue Graphite Metallic



TDI 2-door shown in Candy White

Performance

2.0L, 140 hp, 236 lbs/ft of torque

Six-speed DSG automatic transmission*

Performance at your fingertips. And your toetips.

No matter where you go in your Golf, getting there is more than half the fun thanks to all that German engineering under the hood. The 2.5L Golf sports a 170-hp, in-line five-cylinder engine with 177 lbs/ft of torque that delivers instant gratification off the line and impressive fuel efficiency of 23 city/33 highway mpg on the road.** And the Golf comes equipped with four-wheel independent suspension, electromechanical steering, and a laser seam-welded body for increased rigidity and superior handling. In other words, classic Volkswagen performance.



DSG transmission. When you get the Golf TDI, you also get the option of a six-speed DSG® automatic transmission with Tiptronic.® And that means you can push the gearshift into Tiptronic mode and enjoy the control of imperceptibly fast gear changes that you can make yourself. It's like driving stick—only better.

*Feature available on select models.**2011 2.5L, manual transmission: 23 city/33 highway mpg EPA estimates. Your mileage will vary.

Comfort

Small, big, and comfortable all over.

The Golf may be small when you need to park it, but what it lacks in size on the outside, it more than makes up for on the inside. And that's all due to the hatch back there. Open it wide, fold the rear 60/40-split seats, and you'll have easy access to more than 46 cubic feet of cargo space. Which makes it easy to haul around all the little things in your life, like an eight-piece drum set or a friend's dresser. Of course, the Golf has plenty of room for hauling people too, with seating for five adults, including an eight-way adjustable driver's seat with adjustable lumbar support and available heated front seats for added comfort. So no matter who, or what, you load into your Golf, you can be sure your journey will be a comfortable one.

Power. Glass. Sunroof. With pinch protection, tilt function, and a manual sunshade. All of these features equal one major option designed to make your Golf feel even more comfortable.

*Feature available on select models.

- 60/40-split folding rear seat
- Heated front seats*
- 46 cubic feet of available cargo space



2.5L 4-door shown in Black

Technology loaded with technology.

The Golf isn't just loaded with the latest in technology beneath the hood, it also comes with an AM/FM stereo with eight-speaker sound system, in-dash CD player, and an auxiliary input for seamlessly connecting your MP3 player. The Golf TDI kicks things into overdrive with a touchscreen Premium VIII sound system, Bluetooth® connectivity, iPod® integration using the Media Device Interface (MDI) with iPod cable, and a three-month trial subscription to over 130 channels of SiriusXM Satellite Radio so you never miss a beat.



Touchscreen navigation. The TDI model has an available touchscreen navigation system so you'll always be able to find your way to wherever you're going and back home again. Just in case you want to get lost in the music, or the world, for a little while.

Multi-function steering wheel. With the available multi-function steering wheel, you can control the radio, change a song, or take a phone call all while keeping your eyes on the road and your hands on the wheel.



TDI shown in Titan Black

Safety

There's safety in acronyms.

When it comes to safety, the Golf has it in spades or, should we say, features. A lot of them. That's because it's equipped with active and passive safety features such as Electronic Stability Control (ESC), Anti-lock Braking System (ABS), and the Intelligent Crash Response System (ICRS)* to help you stay safe in virtually every situation. Those are just a few of the reasons the 2011 Golf 4-door has been named a prestigious Top Safety Pick by the Insurance Institute for Highway Safety (IIHS) three years in a row.** All of which makes it safe to say we know a thing or two about safety.

Active safety. Active safety features are the things that help you prevent a collision, such as headlights, turn signals, mirrors, brakes, steering, and traction control elements like ABS and ESC. They may sound basic, but those elements can help save your life.

Passive safety. Passive safety features are what help protect you during an accident, such as safety belts, airbags†, steel-reinforced seating, a safety cage, and crumple zones. You know that German engineering you love under the hood? Well, it's actually throughout the entire car.

*The Intelligent Crash Response System (ICRS) will only activate in a collision where the airbags deploy or safety belt pretensioners activate. Not all collisions cause airbags to deploy or safety belt pretensioners to activate. **2009-2011 "Top Safety Pick" based on 31 mph side-impact crash test, 40 mph frontal-offset crash test, 20 mph rear-impact test, roof strength testing, and the availability of ESC. Test performed by the Insurance Institute for Highway Safety. For details, visit www.iihs.org. See vw.com for more information on safety features. †Airbags are supplemental restraints only and will not deploy under all crash circumstances. Always use safety belts and seat children only in the rear, using restraint systems appropriate for their size and age. This is an illustration and does not depict what will happen in a crash. All bags will not inflate in real-world crashes, and if multiple bags do deploy, they will be in various stages of inflating/deflating and will never all be inflated at the same time.

Highlights

ESC

Electronic Stability Control

ESC helps prevent oversteer or understeer during an evasive maneuver by applying corrective forces to each of the wheels. In other words, it helps you maintain control.



6 standard airbags†



Active

Tire Pressure Monitoring System (TPMS)

You have enough to think about without having to remember to check your tires. So we added the TPMS to help monitor tire pressure and inform you of any loss in pressure.

Anti-Slip Regulation (ASR)

ASR helps prevent your wheels from spinning when you accelerate by denying engine power in situations when it senses wheel slippage.

Anti-lock Braking System (ABS)

Not only does ABS help keep the brakes from locking up during sudden stops, it also helps you retain control over the steering in the event of emergency braking.

Hydraulic Brake Assist (HBA)

HBA helps ensure that you get the maximum power from the brake system by judging the suddenness of the braking and applying extra pressure when you need it most.



TDI 2-door with Sunroof and Navigation shown in Shark Blue Metallic

Passive

Safety cage

Beneath all that sheet metal, every Golf has a specially reinforced safety cage complete with anti-intrusion side beams and heat-formed B-pillars, designed to help protect you in the event of a collision.

Crumple zones

Surrounding the safety cage are crumple zones that provide space and material to help cushion and absorb the impact while the safety cage insulates you.

Crash-optimized front end

Integrated into the front structure of your Golf are impact-absorbing elements that allow for compression during a collision. And that helps minimize the energy that reaches you.

Intelligent Crash Response System (ICRS)

After the airbags have been deployed in a collision, the ICRS automatically unlocks all doors, disables the fuel pump, and turns on the hazard lights.* That's why we call it intelligent.

Golf 2.5L

Golf 2.5L

Includes: 2.5L, 170-hp engine; 5-speed manual transmission; 15" steel wheels with wheel covers and all-season tires; 4-wheel independent suspension; electromechanical speed-sensitive power steering; anti-theft vehicle alarm system; Daytime Running Lights (DRL); Climatic climate control; power windows; power door locks; 8-speaker sound system with MP3- and WMA-compatible in-dash CD player, AM/FM radio, and AUX-in for portable audio players; cloth sport seats with 8-way manually adjustable driver's seat, fully reclining and height-adjustable with adjustable head restraints; 4-way manually adjustable front passenger's seat, fully reclining with adjustable head restraints; 4-wheel disc brakes with Anti-lock Braking System (ABS), Anti-Slip Regulation (ASR), Electronic Brake-pressure Distribution (EBD), Electronic Stability Control (ESC), and Hydraulic Brake Assist (HBA); Tire Pressure Monitoring System (TPMS).

Golf 2.5L with Convenience

Includes Golf 2.5L features, plus: heated front seats and washer nozzles; Bluetooth® technology; adjustable front center armrest.

Golf 2.5L with Convenience and Sunroof

Includes Golf 2.5L with Convenience features, plus: touchscreen Premium VIII sound system with HD Radio,™ MP3- and WMA-compatible in-dash 6-disc CD changer, SD memory card reader, and SiriusXM Satellite Radio with 3-month trial subscription; power tilting/sliding sunroof; Media Device Interface (MDI) with iPod® cable.

Options

6-speed automatic transmission with Tiptronic® and Sport mode. 4-door model includes 2-door features, plus: rear doors; rear power windows; rear child safety door locks; power reclining front seats.

2.5L in-line 5-cylinder

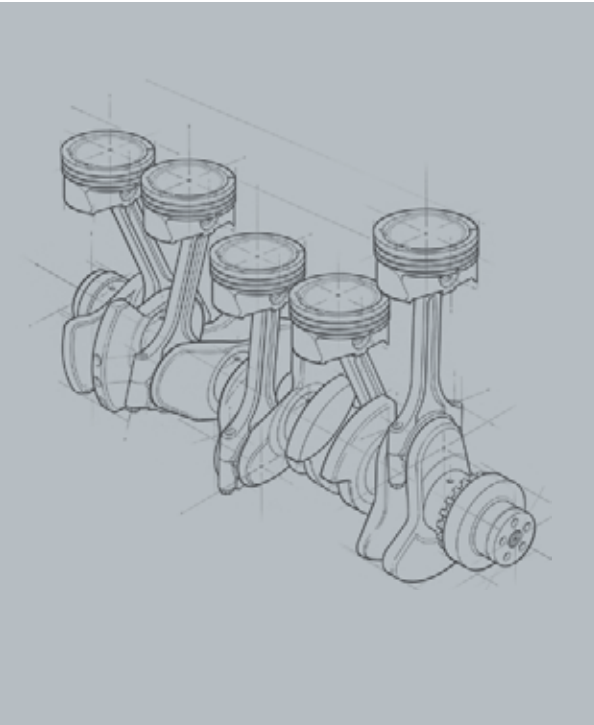

4-wheel independent suspension.

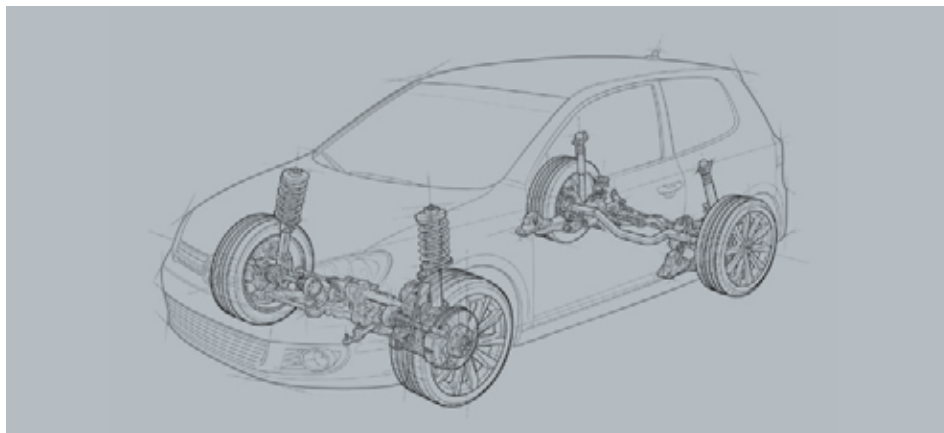

Golf TDI® Clean Deisel

Golf 2.0L TDI Clean Diesel

Includes Golf 2.5L with Convenience features, plus: 2.0L, 140-hp TDI engine; 6-speed manual transmission; sport suspension; fog lights; 17" Salamanca alloy wheels; touchscreen Premium VIII sound system with HD Radio, MP3- and WMA-compatible in-dash 6-disc CD changer, SD memory card reader, and SiriusXM Satellite Radio with 3-month trial subscription; Media Device Interface (MDI) with iPod cable; front and rear floor mats; leather-wrapped multi-function steering wheel, shift knob and brake handle; split-folding rear seat with center armrest and pass-through.

Golf 2.0L TDI Clean Diesel with Sunroof and Navigation

Includes Golf 2.0L TDI Clean Diesel features, plus: power tilting/sliding sunroof; RNS 315 navigation system with 5" color touchscreen in center console.

Golf 2.0L TDI Clean Diesel with Technology Package

Includes Golf 2.0L TDI Clean Diesel with Sunroof and Navigation features, plus: Dynaudio® premium sound system; keyless access with push-button start; Bi-Xenon™ high-intensity headlights with LED Daytime Running Lights and Adaptive Front-lighting System (AFS).

Options

6-speed DSG® automatic transmission with Tiptronic and Sport mode. 4-door model includes 2-door features, plus: rear doors; rear power windows; rear child safety door locks; power reclining front seats.

Specifications

Design	2.5L	TDI
Fully galvanized sheet metal	●	●
Crash-optimized front end	●	●
Tinted glass	●	●
Halogen headlights with clear, lightweight, chip-resistant polycarbonate lenses and Daytime Running Lights (DRL)	●	●
Bi-Xenon high-intensity headlights with LED Daytime Running Lights and Adaptive Front-lighting System (AFS)	–	TP
Power-operated, heated side mirrors with integrated turn signals	●	●
Power tilting/sliding tinted sunroof	CS	SN, TP
Tire Pressure Monitoring System (TPMS)	●	●
15" steel wheels with wheel covers	●	–
17" alloy wheels with anti-theft wheel locks	–	●
Windshield wipers, variable intermittent	●	●
Heated windshield washer nozzles	C, CS	●
Performance	2.5L	TDI
2.5L, 20-valve, DOHC, in-line 5-cylinder engine; 170 hp, 177 lbs/ft of torque	●	–
2.0L, 16-valve, in-line 4-cylinder turbocharged TDI Clean Diesel engine with common rail direct injection; 140 hp, 236 lbs/ft of torque	–	●
Power-assisted front vented disc brakes (288 mm) and rear solid disc brakes (260 mm)	●	●
Electromechanical power steering with variable assistance and active return	●	●
Independent suspension with front MacPherson struts and rear fully independent 4-link suspension	●	●
5-speed manual transmission	●	–
6-speed automatic transmission with Tiptronic and Sport mode	○	–
6-speed manual transmission	–	●
6-speed DSG automatic transmission with Tiptronic and Sport mode	–	○
Comfort	2.5L	TDI
Climatic manual single-zone climate control with pollen filter	●	●
Anti-theft alarm system for doors, hood, trunk, and radio with audible and visual activation	●	●
Front center armrest, adjustable	C, CS	●
Cruise control	●	●
Front and rear floor mats	–	●
Multi-function trip computer featuring compass, trip time, trip length, average trip speed, average trip fuel consumption, current fuel consumption, miles to empty, radio station display, personalizing function	●	●
Speedometer, tachometer, odometer, trip odometer, fuel gauge, coolant temperature gauge, gear indicator (if equipped with automatic transmission), outside temperature, warning lights, and clock	●	●
2 radio-frequency remote transmitter key fobs with lock, unlock, rear hatch release, and panic button for central locking	●	●
Automatic locking feature (doors lock when vehicle reaches 8 mph, unlock automatically upon airbag deployment)	●	●
Child-safety rear door locks (4-door only)	●	●
Driver and passenger visor vanity mirrors, illuminated and with covers	●	●
8-way manually adjustable driver seat, fully reclining and height-adjustable	●	●
Lumbar support, adjustable for driver and front passenger seats	●	●
Heated front seats	C, CS	●
60/40-split folding rear seat	●	–
60/40-split folding rear seat with center armrest and pass-through	–	●
3-spoke steering wheel, height-adjustable, with telescoping steering column	●	–
3-spoke, leather-wrapped, multi-function steering wheel, height-adjustable, with telescoping steering column	–	●

Comfort cont.	2.5L	TDI
Two 12V power outlets: 1 in front, 1 in rear	●	●
3 cupholders, 2 front, 1 rear	●	–
4 cupholders, 2 front, 2 rear	–	●
Titan Black cloth seating surfaces	●	●
Power windows with pinch protection and automatic 1-touch feature, operable from driver's side only	●	●
Technology	2.5L	TDI
8-speaker sound system with MP3- and WMA-compatible in-dash CD player, AM/FM radio	●	–
Touchscreen Premium VIII sound system with MP3- and WMA-compatible in-dash 6-disc CD changer, and 8 speakers	CS	●
RNS 315 navigation and entertainment system with 5" color touchscreen in center console, SiriusXM Satellite Radio with 3-month trial subscription, SD memory card reader, and AUX-in	–	SN, TP
SiriusXM Satellite Radio with 3-month trial subscription	CS	●
Media Device Interface (MDI) with iPod cable	CS	●
AUX-in for portable audio players	●	●
Bluetooth technology	C, CS	●
Dynaudio premium sound system with 8 high-end speakers (4 tweeters, 4 bass/midrange), 300-watt amplifier and DSP (Digital Sound Processor) technology	–	TP
Keyless access with push-button start	–	TP
Safety	2.5L	TDI
Immobilizer III theft-deterrent system	●	●
Driver and passenger front airbag supplemental restraint system*	●	●
Driver and front passenger side thorax airbag supplemental restraint system*	●	●
Rear passenger side thorax airbag supplemental restraint system (4-door only)*	○	○
Front seat safety belt pretensioners with load limiters	●	●
Height-adjustable front 3-point safety belts and 3 rear 3-point safety belts	●	●
LATCH (Lower Anchors and Tethers for CHildren) child seat anchor points	●	●
Electronic Stability Control (ESC), Anti-Slip Regulation (ASR), Electronic Differential Lock (EDL), and Engine Braking Assist (EBA)	●	●
Anti-lock Braking System (ABS), Electronic Brake-pressure Distribution (EBD), and Hydraulic Brake Assist (HBA)	●	●
Intelligent Crash Response System (ICRS) (In the case of airbag* deployment, the doors unlock, the fuel pump is shut off, and the hazard lights are activated.)**	●	●
Quality	2.5L	TDI
12-year/unlimited mileage Limited Warranty Against Corrosion Perforation	●	●
5-year/60,000-mile (whichever occurs first) Powertrain Limited Warranty	●	●
3-year/36,000-mile (whichever occurs first) New Vehicle Limited Warranty	●	●
3-year/36,000-mile (whichever occurs first) Roadside Assistance†	●	●
Volkswagen Carefree Maintenance® Program††	●	●
Dimensions		
Wheelbase	101.5 inches (2,578 mm)	
Length	165.8 inches (4,210 mm)	
Width	70.3 inches (1,786 mm)	
Height	58.3 inches (1,479 mm)	
Cargo volume	15 cu. ft. (0.4 cu. m)	
Cargo volume (with rear seats folded down)	46 cu. ft. (1.3 cu. m)	

- Standard, at no additional cost
- Optional, additional cost
- C Convenience
- CS Convenience and Sunroof
- SN Sunroof and Navigation
- TP Technology Package
- Not Available

*Airbags are supplemental restraints only and will not deploy under all crash circumstances. Always use safety belts and seat children only in the rear, using restraint systems appropriate for their size and age. **The Intelligent Crash Response System (ICRS) will only activate in a collision where the airbags deploy or safety belt pretensioners activate. Not all collisions cause airbags to deploy or safety belt pretensioners to activate. †Roadside Assistance provided by Signature Motor Club, Inc., and Signature Motor Club of California, Inc. ††The Volkswagen Carefree Maintenance Program covers the vehicle's scheduled maintenance for three years or 36,000 miles, whichever comes first. Coverage during the term of the new vehicle limited warranty at no additional charge. Some limitations apply. See dealer or vehicle maintenance program booklet for details.

Wheels

Accessories

Exterior

Interior

Standard

drivergear.vw.com



17" Salamanca



MojoMat®



Monster Mat®



Rear Hatch Spoiler



Heavy Duty Trunk Liner with CarGo Blocks



Base Carrier Bars with Bike Holder Attachment



Base Carrier Bars with Snowboard/Ski Attachment



17" Bi-Color Onyx



18" Topas



18" Karthoum

Paint

Cloth

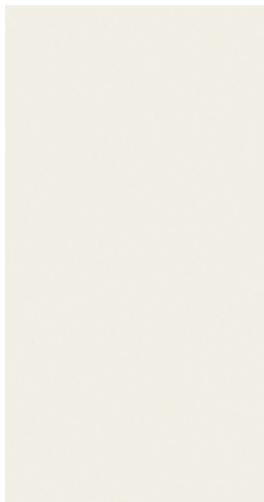

Candy White

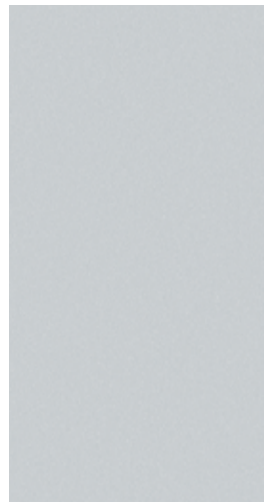

Reflex Silver Metallic

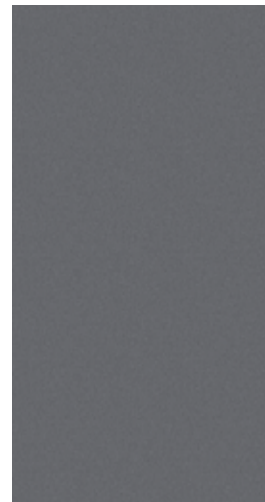

United Gray Metallic

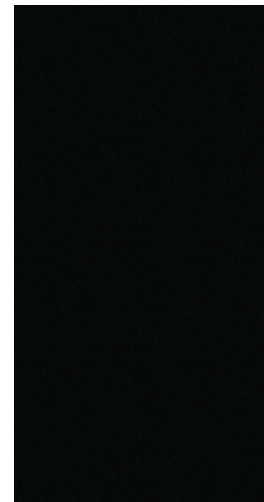

Black



Titan Black



Tornado Red



Shark Blue Metallic



Blue Graphite Metallic



That's Das Auto.

2012 Volkswagen Family

All-new Beetle



All-new Passat



Tiguan



Jetta



Eos



Golf



Touareg



CC



GTI



Jetta SportWagen



Routan



vw.com

©2011 Volkswagen of America, Inc. Printed in the U.S.A. Volkswagen of America, Inc., believes the specifications in this brochure to be correct at the time of printing. Specifications, standard equipment, options, fabrics and colors are subject to change without notice. Some features may be unavailable when your vehicle is built. Some vehicles are pictured with options that may be available at extra cost or may not be available on some models. Ask your dealer about availability of options and verify that the vehicle you ordered includes the equipment you ordered. Tires are supplied and warranted by their manufacturer. "Volkswagen," the Volkswagen logo, "Das Auto," "Golf," "TDI," "DSG," and "Climatronic" are registered trademarks of Volkswagen AG. "Carefree Maintenance," the Carefree Maintenance logo and Side Curtain Protection are registered trademarks of Volkswagen Group of America, Inc. "Tiptronic" is a registered trademark of Dr. Ing. h.c. F. Porsche AG. "Bi-Xenon" is a registered trademark of Hella, Inc. U.S.A. "Bluetooth" is a registered trademark of Bluetooth SIG, Inc. "iPod" is a registered trademark of Apple, Inc. All rights reserved. iPod is not included. Subscriptions to all SiriusXM services are sold separately after 3-month trial expires. **If you decide to continue your SiriusXM service at the end of your subscription, the plan you choose will automatically renew and bill at then-current rates until you call 1-866-635-2349 to cancel. See SiriusXM Customer Agreement for complete terms at www.siriusxm.com.** Sirius U.S. Satellite service available only to those at least 18 years of age in the 48 contiguous U.S.A., D.C. and P.R. (with coverage limitations). Sirius, XM and all related marks and logos are trademarks of Sirius XM Radio Inc. Volkswagen DVD navigation depends on the signals from the worldwide Global Positioning Satellite network. The vehicle's electrical system, and existing wireless and satellite technologies, must be available and operating properly for the system to function. The system is designed to provide you with suggested routes to location addresses, destinations, and other points of interest. Changes in street names, construction zones, traffic flow, points of interest, and other road system changes are beyond the control of Volkswagen of America, Inc. Complete detailed mapping of lanes, roads, streets, toll roads, highways, etc., is not possible, therefore you may encounter discrepancies between the mapping and your actual location. Please rely on your individual judgment in determining whether or not to follow a suggested navigation route. Periodically, the mapping is updated and a new DVD will be required in order to maintain the latest navigation information available to us. These will be available for purchase from time to time at additional cost. For further information regarding any Volkswagen model, please call 1-800-DRIVE-VW, or just look us up at vw.com. VW12GOLFSBUS