

BMW M3



The Ultimate Driving Machine®



THE BMW M3 COUPE AND CONVERTIBLE.

MORE M THAN EVER BEFORE.

Contents

BMW M3 Coupe | BMW M3 Convertible

04 | 13 Exterior BMW M3 Coupe

14 | 15 Interior BMW M3 Coupe

16 | 27 Exterior BMW M3 Convertible

28 | 29 Interior BMW M3 Convertible

Technology

30 | 31 Engine

32 | 33 M Double Clutch Transmission (M DCT) with Driveline I M3 on the Nürburgring

34 | 35 Chassis | Lightweight construction

36 | 37 M3 heritage

Equipment

38 | 41 Paints | Upholsteries | Interior trims | Combinations

42 | 43 Equipment details

44 | 45 Technical data

46 | 47 Build Your Own | BMW Driver Training

48 | 49 BMW Services

“M” – THE MOST POWERFUL LETTER IN THE WORLD.



BMW M3 Coupe

M3 Coupe shown with the following equipment:

Engine: 4.0-liter naturally aspirated V-8 engine
Output: 414 hp @ 6300 rpm
Torque: 295 lb-ft @ 3900 rpm
Wheels: Double Spoke (Style 220M) 19" light alloy
Exterior color: Alpine White
Upholstery: Palladium Silver Novillo
Extended Leather
Interior trim: Carbon Leather

For details on Technical data and specifications, please refer to page 44–45.



BMW M3 Convertible

M3 Convertible shown with the following equipment:

Engine: 4.0-liter naturally aspirated V-8 engine
Output: 414 hp @ 6300 rpm
Torque: 295 lb-ft @ 3900 rpm
Wheels: Double Spoke (Style 220M) 19" light alloy
Exterior color: Jerez Black Metallic
Upholstery: Bamboo Beige Novillo
Extended Leather
Interior trim: Sycamore Anthracite Wood

For details on technical data and specifications, please refer to page 44–45.

A 414-hp, high-rev V-8 engine. A degree of agility never before experienced. And dynamic handling that can't be described but only felt. The fourth-generation BMW M3 – in Coupe and Convertible form – is a legend in the making. Discover for yourself how the exceptional M3 is as impressive on the road as it is on the racetrack. And experience the exhilaration that is BMW M.

Visit bmwusa.com/M to explore BMW M.





RAISING THE PULSE OF RACEDRIVERS: THE BMW M3 COUPE.

Dubai Autodrome, 100 degrees in the shade. The M3 Coupe is already in pole position. Since its inception, the BMW M3 has embodied the very soul of motorsport. Now it's setting a new benchmark on the world's racetracks. Virtually all components have been constructed from the ground up with one goal: to exceed the capabilities of its illustrious predecessor. A muscular, racing-inspired 4.0-liter V-8 engine is a driving enthusiast's dream. The M3's intelligent lightweight construction contributes to its dynamic responsiveness and sporty road feel. The look is designed to set your pulse racing. Get behind the wheel – and experience the thrill of purebred sports car performance.





**MUSIC TO YOUR EARS
AT 8400 BEATS PER MINUTE.**

One of the V-8's many motorsport-inspired advances: using eight separate throttle butterflies, one for each cylinder, to deliver faster engine response and greater overall performance and efficiency. Another is BMW's variable Double-VANOS technology, which precisely adjusts valve timing all the way up to the M3's staggering 8400-rpm redline. It's engineering like this that contributes to the M3 Coupe's 0-60 time of an incredible 4.5 seconds.¹ Trust BMW M to turn the tarmac into your paved playground.

¹BMW AG test results with M Double Clutch Transmission.
BMW urges you to obey all posted speed laws and always wear safety belts.

**TO ACHIEVE THE M3'S SUPERIOR HANDLING,
OUR ENGINEERS HAD TO LIGHTEN UP.**

Along with faster 0-60 times, reducing a vehicle's weight also helps deliver lightning-quick responsiveness and uncanny driving dynamics. BMW's intelligent lightweight engineering gives the latest generation M3 an enviable weight-to-power ratio of 8.9 lbs/hp. The M3's suspension, for example, uses weight-optimized components, like an aluminum front axle. The M3 Coupe's carbon-fiber roof weighs 11 lbs. less than a steel roof, and 45 lbs. less than a steel moonroof. By reducing the weight of the roof, BMW lowers the center of gravity, thus minimizing body roll and enhancing grip through turns.





A SHIFT IN THE ULTIMATE DRIVING PARADIGM.

As signified by its V-8 engine, the BMW M3 raises the bar for high-performance vehicles in virtually every respect. The standard M3 transmission is a smooth 6-speed manual, with a heavy-duty clutch for immediate pickup at the starting line and during shifting. Piloting the M3 through gear after gear all the way up to the 8400-rpm redline is the perfect way to take advantage of all 414 horses. And when it comes to stopping power, the M3 is no less impressive. Massive 14" cross-drilled compound brakes work in conjunction with Dynamic Brake Control and a special high-performance-tuned anti-lock braking system for reliable, responsive vehicle control in virtually any conditions. In the racing-inspired world of the M3, there is no room for anything less.



**ON EVERY ROAD, YOU'RE ON THE FAST TRACK
TO DRIVING PLEASURE.**

From the racetrack to the open road, the BMW M3 Coupe never fails to amaze. It combines the dynamics and agility of a sports car with everyday practicality and comfort. Thanks to the finely tuned lightweight chassis with Electronic Damping Control, you can set damper settings to one of three levels – Comfort, Normal or Sport. Available in the M3 Coupe, both the Sport mode and Dynamic Stability Control (DSC) are tuned for more athletic handling with the Competition Package. This package also enhances the M3's performance via a lowered suspension and Y Spoke (Style 359M) 19" forged alloy wheels. In both models, DSC's suspension control system provides enhanced driver feedback, as does the Variable M Differential Lock, which delivers enhanced stability and increases grip. You enjoy the exceptional start-up and acceleration, even under challenging conditions.

Get the latest information on BMW standard and optional features, packages and technical specifications. Visit bmwusa.com, select the BMW model of your choice, and click on "Features & Specs."



STEP INSIDE AND PREPARE FOR TAKEOFF.

You'll find the M3 interior sleek, athletic and totally energizing. Just the sight of the signature M trim and logo on the door sills can raise any driver's pulse. And like the cockpit of any track-worthy vehicle, you're in total control. Grip the thick, leather-wrapped rim of the compact multi-function M sport steering wheel. It's designed to help you handle demanding high-performance maneuvers. Modify your vehicle setup through buttons located on the center console, next to the shift lever. Eye-catching back-lit instrument dials with glowing red tach hands provide vital driving information at a glance. Check the oil temperature gauge, as well as the tach that displays maximum available revs, which increase as the engine warms up.

The M3 cabin is finished in luxurious materials of the highest quality, such as Novillo Leather upholstery finished in a choice of Black, Palladium Silver, Bamboo Beige or Fox Red. Handsome trim accents are set off by the dark Anthracite lining the roof and the top half of the instrument panel.

Body-hugging, fully adjustable M sport seats offer adjustable backrest widths for improved support in the sharpest turns. The road beckons, so strap yourself in. It's time to drive.

Get the latest information on BMW standard and optional features, packages and technical specifications. Visit bmwusa.com, select the BMW model of your choice, and click on "Features & Specs."



**THE M3 CONVERTIBLE:
OPEN TO LIFE ON THE EDGE.**



THE HOTTEST PERFORMER UNDER THE SUN.

Up ahead: the legendary city circuit in sun-drenched Monaco. Under your control: the M3 Convertible, the key to both high-performance excitement and open-air exhilaration. The M3 Convertible turns the roadway into a runway, thanks to BMW's muscular 414-hp V-8 engine. This racing-inspired powerplant, combined with the 7-speed M Double Clutch Transmission (M DCT) with Drivelogic, is a driving enthusiast's dream. From the lightweight aluminum suspension that improves handling, to M Drive that allows you to set performance parameters, to the retractable hardtop, virtually all of the M3 Convertible's components are designed with one goal: a stimulating driving experience on the highest performance level.

The Monaco Grand Prix was first held in 1929. The 2.07-mile-long circuit has been part of the Formula One World Championship since 1955. Due to the unique terrain and the often difficult racing conditions, this circuit is considered the ultimate test in the entire championship schedule.

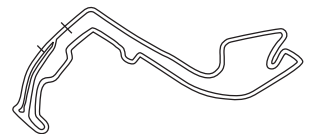

HANDLING THAT CAN BE ADAPTED TO FIT EVERY MOOD.

Get behind the wheel of the M3 Convertible, and you open up a new world of inspired and exhilarating driving possibilities at every turn. That's why BMW offers M Drive – to provide a comprehensive array of choices when it comes to personalizing your M3 Convertible's driving feel. Normally, Dynamic Stability Control (DSC) helps to deliver optimal traction, including track-oriented M Dynamic Mode (MDM), which allows for more wheelslip and yaw angle. Electronic Damping Control (EDC) can be set to Comfort, Normal or Sport, depending on your preferred handling settings and the surface of the road. Engine response can be tweaked via a button in the center console, which calls up Normal, Sport or Sport Plus programs. But however you configure it, the M3 Convertible brings together unmatched levels of responsiveness and control – as only BMW M can deliver.

Get the latest information on BMW standard and optional features, packages and technical specifications. Visit bmwusa.com, select the BMW model of your choice, and click on "Features & Specs."





Straightaways can become hairpin turns in the blink of an eye. But the M3's suspension design handles whatever the road throws at it with finesse. At the heart of the M3's responsiveness is a front axle made primarily of aluminum; an additional thrust plate across the entire frame adds stability, making the front axle not only lightweight, but extremely rigid. The five-arm rear suspension features all-aluminum track control arms and dampers; compared to construction using more conventional material, it's stiffer and 5.5 lbs. lighter. Anti-roll bars, front and rear, and two additional longitudinal bars contribute to the M3's powerful, sporty dynamics and road feel. The M3's agile suspension frees the rest of its innovative, performance-enhancing features to operate to their most thrilling capacity.

**MASTERING ANY ROAD WITH BREATHTAKING
AGILITY: THE BRILLIANT M SUSPENSION.**



**EVEN WITH THE TOP DOWN,
THERE'S NOTHING "CASUAL" ABOUT IT.**

Adhering to a time-honored M tradition, the M3 Convertible's form follows its high-performance function. It's no coincidence that the M3 looks fast – its distinctive features are designed for peak performance. Intelligently placed air intakes in the front, sides and hood allow proper ventilation for the V-8 engine. Wheel-well extensions accommodate its wider stance; the flat underfloor provides improved aerodynamic efficiency as the M3's speed increases. The 18" M-style Double Spoke light alloy wheels and polished quad tailpipes also contribute to its daunting appearance. And with the top down, the M3's dynamic silhouette perfectly embodies the look of unparalleled driving joy.

Shown: Double Spoke (Style 220M) 19" polished and forged M light alloy wheels.

Get the latest information on BMW standard and optional features, packages and technical specifications. Visit bmwusa.com, select the BMW model of your choice, and click on "Features & Specs."



The M3's retractable roof is far more than just a steel version of a softtop. When raised, the full roofliner effectively insulates the interior against cold and exterior noise. At the push of a button on the center console, a motor electrohydraulically begins the process of lowering the top. First, the roof is separated into three sections, which then smoothly move towards the rear and stack one above the other. At the same time, the trunk lid unlocks at the front and swings up. The stacked roof sections are lowered into a special storage compartment; the trunk lid closes. Total time from top-up to top-down: 22 seconds. The trunk can now be opened from the back, and gently closed using the soft-close feature.

The roof can also be raised and lowered by using the key fob buttons when the M3 Convertible is equipped with Comfort Access. This option also includes the Comfort Opening and Loading feature: to stow large packages in the trunk when the top is down, a touch of the remote button raises the stacked roof up and conveniently out of the way, letting you access more trunk space; another press lowers it back down. All of which makes the M3 Convertible hardtop not just one of the sleekest, most beautiful convertible hardtops on the road today, but the smartest, as well.

Get the latest information on BMW standard and optional features, packages and technical specifications. Visit bmwusa.com, select the BMW model of your choice, and click on "Features & Specs."

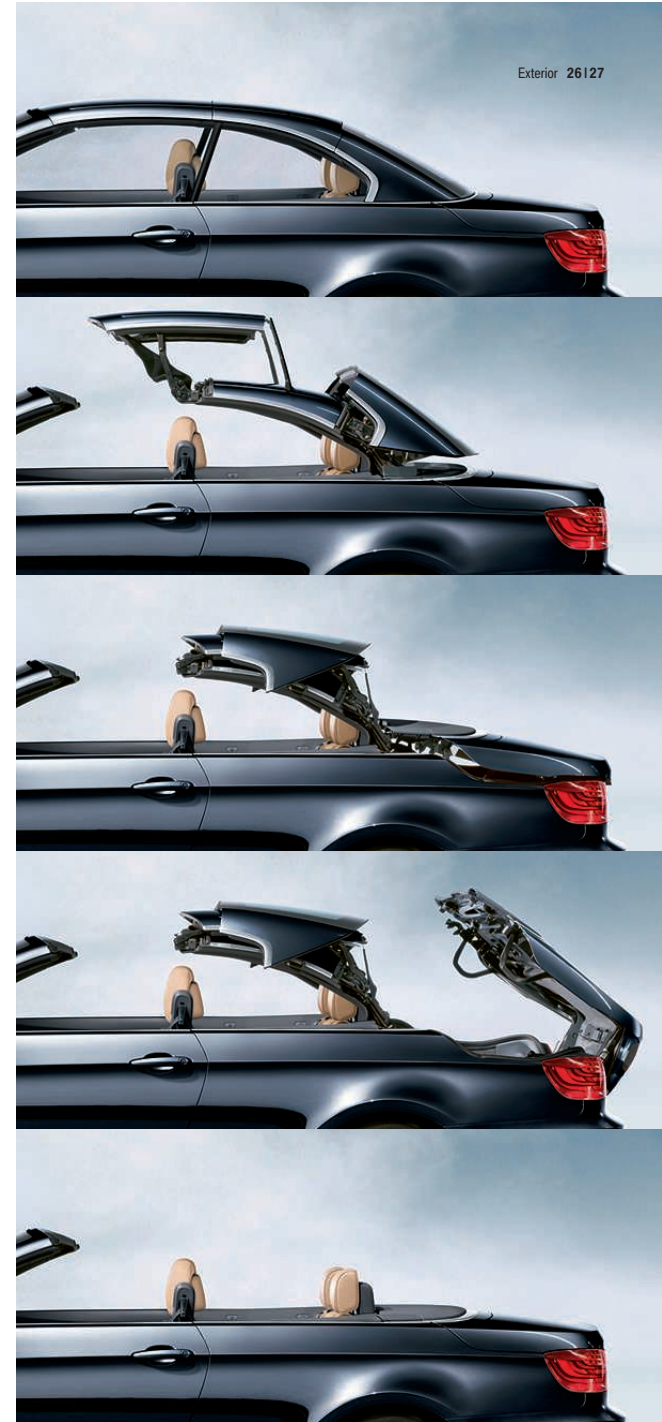



**IF YOU'RE GOING FOR DRIVING PLEASURE,
GO ALL THE WAY.**

The M3 Convertible interior is sleek, athletic and totally energizing. At night, the driver-oriented cockpit is bathed in the glow of back-lit instrument dials, their illuminated red needles providing vital driving information at a glance. Strap yourself into the body-hugging M sport seats with adjustable backrest width, upholstered in handcrafted Novillo Leather. Thanks to Sun-Reflective Technology, the seats remain cooler even when parked in the sun with the top down. A selection of trims – Titanium Shadow, Blue-gray Brushed Aluminum, Sycamore Anthracite Wood or Carbon Leather – lets you further customize the interior. Treat your ears to the sound of one of the world's most exhilarating exhausts, or enjoy your favorite soundtrack via the Enhanced Premium Sound audio system. You can also add Sirius Satellite Radio, or simply hook up your iPod® to the iPod and USB adapter and pick your playlist from buttons on the steering wheel. The M3 Convertible offers a truly sumptuous level of luxury, comfort and convenience for a high-performance vehicle.

Get the latest information on BMW standard and optional features, packages and technical specifications. Visit bmwusa.com, select the BMW model of your choice, and click on "Features & Specs."

THE HIGH ART OF M POWER.

Speed. Power. Control. Three things on the mind of every BMW M engineer. In designing the M3's engine, no corners were cut, and no boundaries were set. Their efforts resulted in a powerful 4.0-liter V-8 engine, with a dynamic 414-hp output and 295 lb-ft of available torque, as well as a maximum engine speed of 8400 rpm. It's the kind of muscle that will catapult the M3 Convertible from 0-60 in just 5.1 exhilarating seconds.¹ To accommodate the naturally aspirated engine, the M3 hood features a contoured powerdome and dual air intakes.

Thanks to the M3 engine block's special aluminum/silicon-alloy construction, the cylinder surface is created by the exposed hard silicon crystals in the alloy. This eliminates the need for conventional coated

cylinder bores. For increased structural stability, the M3 V-8's crankcase is milled as a complete forging.

To achieve smooth power distribution throughout the rpm range, the M3's engine is tuned to truly track-worthy specifications. BMW's Double-VANOS technology ensures pinpoint-accurate valve timing, which allows for optimal combustion at every rev range, while lowering emissions.

In keeping with the M3's racing-inspired engineering, eight separate throttle butterflies operate precisely and independently, delivering amazingly quick throttle response. In addition, the engine's oil supply is carefully regulated by an advanced wet sump system to ensure adequate lubrication under any

conditions. The result: breathtaking acceleration out of the turns and onto the straightaways.

An equally innovative engine management system enhances performance. Ion flow technology monitors the V-8's combustion process via the spark plugs, helping to prevent knocking. How far can revolutionary BMW technology take you? Hit the M3's Start button and find out.

Visit bmwusa.com/M to explore M engine technology.

¹ BMW AG test results, 6-speed manual transmission; 4.9 seconds with 7-speed M Double Clutch Transmission. BMW urges you to obey all posted speed laws and always wear safety belts.

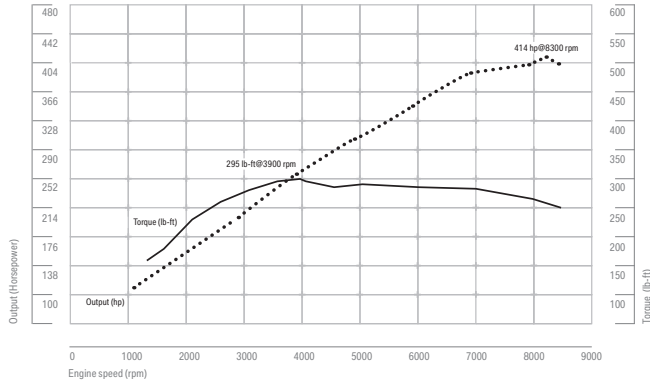

In 2008, 2009, 2010 and 2011, a panel of the world's leading automotive journalists named the M3's 414-hp V-8 engine "Best 3.0- to 4.0-Liter Engine" at the International Engine of the Year Awards.



Auto Start/Stop function. The M3 engine will automatically shut down when the driver activates the clutch, switches to neutral and the vehicle is stationary. The engine restarts as soon as the clutch is activated again. This innovation significantly reduces fuel consumption, especially in city traffic. It is also used in conjunction with M DCT with Drivelogic.

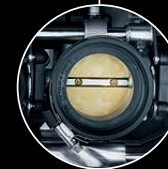

Eight individually adjustable single throttle butterflies allow for instantaneous engine response.

With optional M DCT – 7-speed M Double Clutch Transmission – the M3 Convertible shifts like a racecar, only faster.

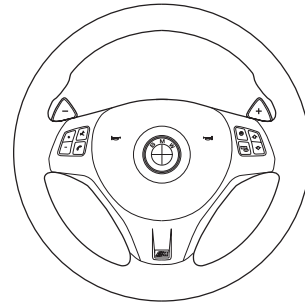

M DCT WITH DRIVELOGIC. A TRANSMISSION THAT'S ON A COMPLETELY DIFFERENT WAVELENGTH.

BMW M DCT with Drivelogic: a transmission option that is worthy of the M3's breathtaking driving dynamics.

This 7-speed M Double Clutch Transmission (M DCT) with Drivelogic uses two transmission structures in one large housing. First, third, fifth and seventh gears are grouped in one structure; second, fourth and sixth gears are grouped in the other. When upshifting or downshifting, the system switches between the two structures, so that while one gear is being disengaged, the next is already in position. And M DCT with Drivelogic can even tailor gear use to your own driving needs. Choose from 11 different programs: six in Sequential mode, and five in Automated mode. In either mode, you can access the whole spectrum of the M3's track-inspired shifting dynamics.

Even racing fans are impressed with the results: M DCT with Drivelogic delivers lightning-fast shifts that rocket you to top gear in the blink of an eye. In manual mode, change gears by using either the shift lever,

or steering wheel-mounted paddle shifters. It shifts like a racecar – only faster. In Sequential mode, the shift times vary, but in the sportiest programs, seamless shifts take only milliseconds to complete. You even get a prompt to indicate the ideal moment to change gears. In Automated mode, the system performs shifts automatically, with action so smooth you'll barely feel them at all.

In addition to its superior performance on the road, the M DCT transmission with Drivelogic offers a range of functions for even more convenience. The LowSpeed Assistant makes parking easier, while the Auto-P function activates the handbrake once the engine is turned off, and selects the gear with the highest traction when you restart your vehicle.

Get the latest information on BMW standard and optional features, packages and technical specifications. Visit bmwusa.com, select the BMW model of your choice, and click on "Features & Specs."

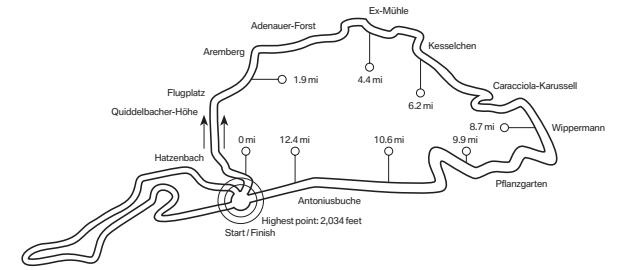

"GREEN HELL" ON THE NÜRBURGRING, PARADISE FOR OUR ENGINEERS.

A BMW engineer's log while testing the M3 on the Nürburgring's Nordschleife:

Tuesday morning, 9:13 am, air temperature 58° Fahrenheit. Dry asphalt, a cloudy sky. Press the Start/Stop button briefly, and the high-speed V-8 induction engine springs to life. A glance at the instrument panel. A glance at the route. Concentrate and: go!

The BMW M3 powers away with a turbine-like power delivery. Then: Hatzenbach. The first bend on the Nordschleife is unsparing as it lays bare the vehicle's suspension characteristics. Steer sharply to the right and then to the left. It'll need a lot more than that to bring this aluminum chassis off track. The BMW M3 takes the bend neutrally and accurately.

Onward, up the Quiddelbacher-Höhe. The road is narrow and undulating. The BMW M3 speeds up to 124 mph, the engine powers on ceaselessly. Upsurge: minimal. The aerodynamics molds itself around the vehicle like the M seat around the driver. After Flugplatz and Schwedenkreuz, the first tough braking area by Aremberg – and after that, top speed down the Fuchsröhre. The build: extremely torsion-stiff and bend-resistant. Fourth mile. Adenauer-Forst. Precise, rapid load change at the limit. Road section Breidscheid: the cloud cover cracks open, the high-performance compound brakes glow – but stay steady.

Now to the right, up the Ex-Mühle. The V-8 powerplant revs up, the cooling system shows no sign of strain. The BMW M3 effortlessly

climbs the steep incline up to Bergwerk, on over Kesselchen toward the legendary steep section: formidable driving stability – the Variable M Differential Lock performs brilliantly. Then into the Caracciola-Karussell's 180-degree banked turn: straining right to the limit – particularly the wheel suspension.

On over Wippermann. The handling is almost playful. To Pflanzgarten. Taut, but not tough – the spring and damper tuning. Finally Antoniusbuche, a long stretch, top speed 155 mph, the road studded with bumps. Superb longitudinal dynamics. Then the finish line is in sight. Hands tremble. The new BMW M3 falls silent. The V-8 engine crackles softly.

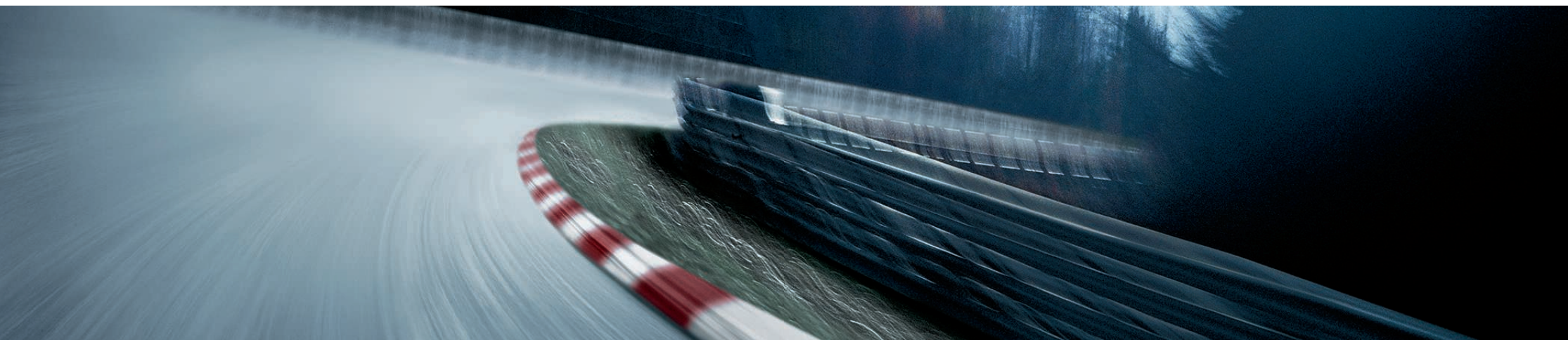

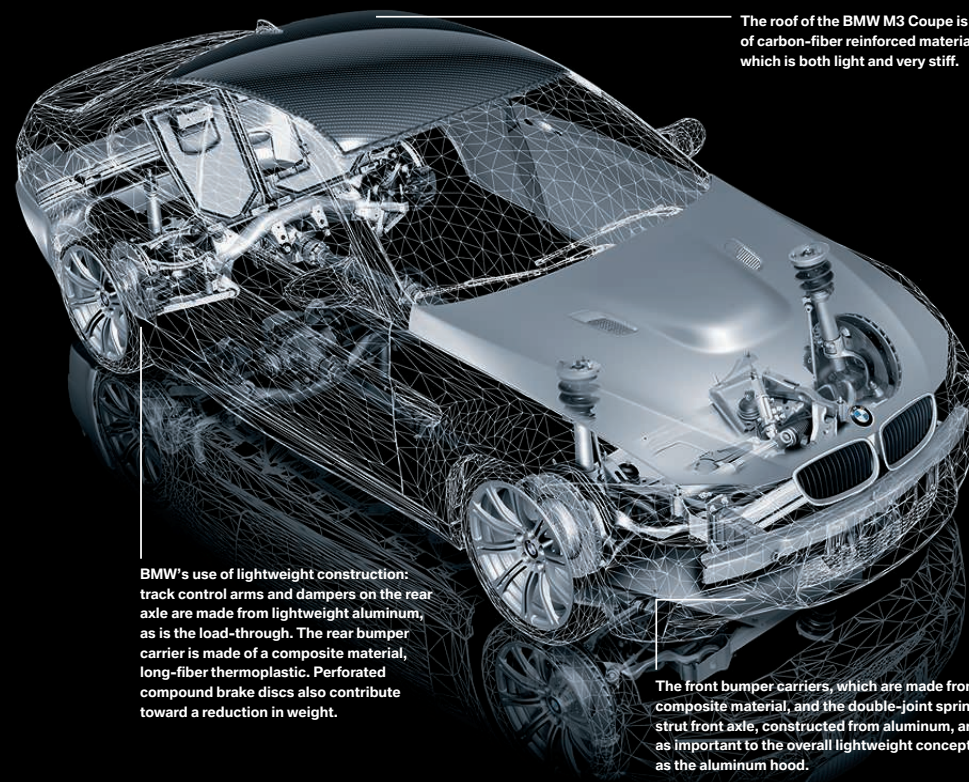
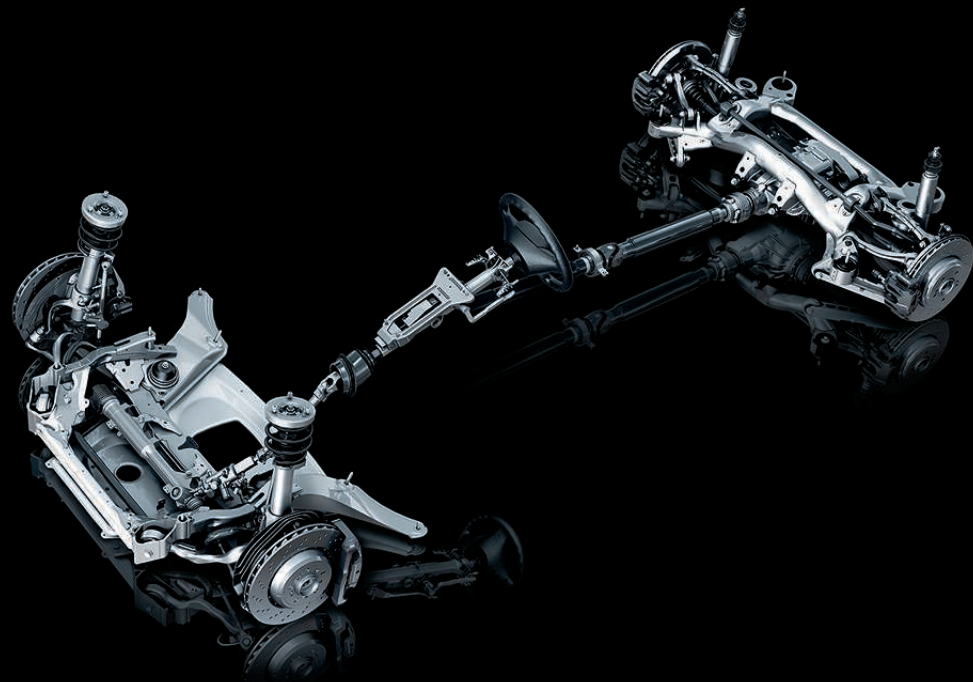

The roof of the BMW M3 Coupe is made of carbon-fiber reinforced material, which is both light and very stiff.

BMW's use of lightweight construction: track control arms and dampers on the rear axle are made from lightweight aluminum, as is the load-through. The rear bumper carrier is made of a composite material, long-fiber thermoplastic. Perforated compound brake discs also contribute toward a reduction in weight.

The front bumper carriers, which are made from composite material, and the double-joint spring-strut front axle, constructed from aluminum, are as important to the overall lightweight concept as the aluminum hood.

A DRIVE THIS INSPIRING STARTS WITH A HIGH-PERFORMANCE PLATFORM.

When is a "sporty" vehicle considered truly "high performance"? When every component works together seamlessly. That's where the M3 shines. At the heart of the M3's responsive handling lies a front axle made primarily of aluminum, including the central subframe, the spring struts, the swivel bearings, and an additional thrust plate across the entire frame for added stability. As a result, the front axle is not only lightweight, it's extremely rigid.

Redesigned from the ground up – except for a single trailing link borrowed from the 3 Series platform – the five-arm rear axle features all-aluminum track control arms, as well as

aluminum dampers. And when compared to construction using more conventional materials, the rear axle is stiffer and 5.5 lbs. lighter.

Optimized for weight and stability, anti-roll bars are featured in both the front and rear of the M3's chassis. Once again, special engineering of the axle geometry (which features two additional longitudinal bars) contributes to the M3's powerful, sporty dynamics and road feel.

Working in conjunction with the suspension, the M3's final drive features a Variable M Differential Lock, which provides up to 100%

locking action for optimal traction on any surface, in any conditions.

The suspension design allows the rest of the vehicle's innovative, performance-enhancing features – from the heavy-duty manual transmission to the M3 Coupe's carbon-fiber roof – to operate at their most thrilling capacity. It's the solid foundation that plays a huge role in the M3's unmatched driving dynamics.

HIGHER PERFORMANCE STARTS AT THE TOP WITH LESS WEIGHT.

The M3 benefits from lightweight construction – in its suspension, its perforated compound brake discs, aluminum hood, and even its composite front fenders. But just reducing weight isn't enough to optimize a vehicle's driving dynamics. That's why BMW reduced weight in areas where it would have a positive effect on driving characteristics. M-style agility is achieved by concentrating the vehicle's weight as close as possible to its center of gravity. Accordingly, BMW used carbon-fiber reinforced material – a particularly light and extremely rigid high-tech composite – in the roof of the M3 Coupe, to lower the vehicle's center of gravity. And when combined with

the M3's near-perfect 50/50 balance front and rear, the advantages of lighter weight and a lower center of gravity become obvious in the M3's powerful drive, high-revving pickup, improved roadholding and shorter braking distances.

ONE LETTER. ONE NUMBER. ONE LEGEND: M3.

192 hp

240 hp

333 hp

414 hp



BMW M3, 1987–1991



BMW M3, 1995–1999



BMW M3, 2001–2006



BMW M3, from 2007

The very first BMW M – the legendary M1 – shot straight to the top in 1978 as one of the fastest German road-going sports cars. And once BMW M tasted success, they never wanted to give it up.

Uncompromising and practical, with exceptional quality down to the smallest detail, M Cars offer BMW Motorsport technology in a production vehicle. For over three decades, M Cars have been created for those who view outstanding achievement as an everyday occurrence.

The BMW M3 made its initial debut in 1987, and from the very beginning, its performance was unrivaled. With a 192-hp, 16-valve, four-cylinder engine, the M3 legend was created. The second BMW M3 was launched in 1995, a milestone distinguished by its 240 hp and array of technological highlights.

In 2001, the third-generation BMW M3 set the benchmark for combining the thrill of motorsport and everyday functionality. At its heart was a high-revving, 333-hp, six-cylinder engine. And today, the 414-hp, V-8 M3 continues the BMW M tradition.

The engine, transmission, suspension and aerodynamics are all in perfect harmony. This powerful high-rev concept with its unique lightweight technology transfers motorsport innovation directly to the road.

That's why BMW M develops and tests its cars on the notorious Nürburgring Nordschleife. This is where racing legends – and cars that carry the M name – are born.

BMW M: inspirational vehicles that are prized on the race circuit – and on the road home.

The pages in this section show available colors and materials for the BMW M3 models. Use these samples to compare paint, upholstery, trim colors and combinations. Please note that these samples are

representations; they are not exact reproductions. To see the actual colors, visit your local BMW center. They will be happy to show you original samples and assist you with special requests.

bmwusa.com/byo

Please note: All M3 Convertible leather upholstery includes Sun-Reflective Technology.

Exterior colors

300 Alpine White Non-metallic

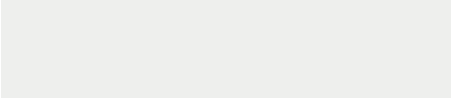

668 Jet Black Non-metallic

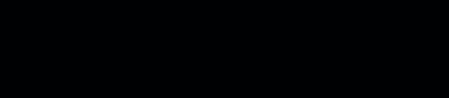

A96 Mineral White Metallic



A29 Silverstone Metallic



381 Le Mans Blue Metallic



A30 Interlagos Blue Metallic



A52 Space Gray Metallic



A75 Melbourne Red Metallic



A73 Jerez Black Metallic



Get the latest information on BMW standard and optional features, packages and technical specifications. Visit bmwusa.com, select the BMW model of your choice, and click on "Features & Specs."

Upholstery materials and colors

GEAT Anthracite and Black Cloth/Leather

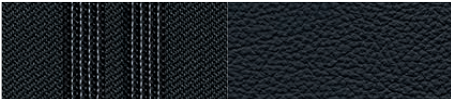

See Recommended color combinations chart on page 41 for details on limitations and exclusivity when selecting exterior paint colors and upholstery materials and colors.

NCH3 Bamboo Beige Novillo Leather



NCH1 Palladium Silver Novillo Leather



NCH2 Fox Red Novillo Leather



NCSW Black Novillo Leather



NCH4 Palladium Silver/Black Novillo Leather

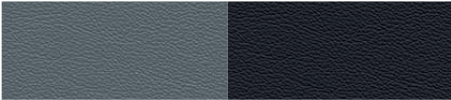

NCH5 Fox Red/Black Novillo Leather

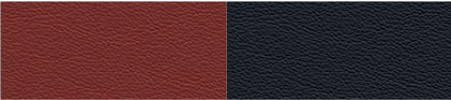

Recommended color combinations

Upholstery material	Anthracite and Black Cloth/Leather ¹		Novillo Leather ² /Extended Novillo Leather ³					
	Anthracite/Black		Bamboo Beige	Palladium Silver	Fox Red	Black	Palladium Silver/Black	Fox Red/Black
Upholstery colors								
Exterior colors								
300 Alpine White Non-metallic ⁴		•	•	•	•	•	•	•
668 Jet Black Non-metallic ⁴		•	•	•	•	•	•	•
A96 Mineral White Metallic ⁵		•	•	•	•	•	•	•
A29 Silverstone Metallic ⁵		•	•	•	•	•	•	•
381 Le Mans Blue Metallic ⁵		•	•	•	•	•	•	•
A30 Interlagos Blue Metallic ⁵		•	•	•	•	•	•	•
A52 Space Gray Metallic ⁵		•	•	•	•	•	•	•
A75 Melbourne Red Metallic ⁵		•	•	•	•	•	•	•
A73 Jerez Black Metallic ⁵		•	•	•	•	•	•	•
Interior trims								
771 Titanium Shadow ⁴		•	•	•	•	•	•	•
4MX Blue-gray Brushed Aluminum ⁵		•	•	•	•	•	•	•
4MY Carbon Leather ⁵		•	•	•	•	•	•	•
4MZ Sycamore Anthracite Wood ⁵		•	•	•	•	•	•	•

¹ Standard in M3 Coupe; not available in M3 Convertible.
² Standard in M3 Convertible; optional in M3 Coupe.
³ Optional; requires Navigation system or Convenience Package.
 Extended Novillo Leather covers the instrument panel below the trim line, the glovebox lid and the center console sides.
⁴ Standard.
⁵ Optional.

Please note: All M3 Convertible leather upholstery includes Sun-Reflective Technology.

Interior trims

771 Titanium Shadow

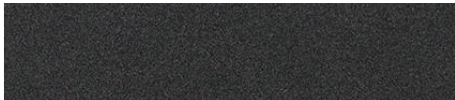

4MX Blue-gray Brushed Aluminum



4MY Carbon Leather

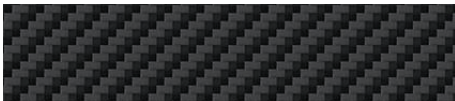

4MZ Sycamore Anthracite Wood

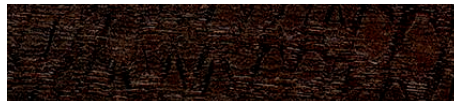



The BMW M3 Coupe's carbon-fiber roof.



Feel the passion that races through the M3 Competition Package. Developed to take the BMW M3 Coupe to the far edge of street-legal, it enhances the M3's athletic stance by lowering the suspension 10 mm (.39") for enhanced aerodynamics. Performance-enhancing technologies include Electronic Dynamic Damping Control (EDC) – which, along with Dynamic Stability Control (DSC), offers a special Sport mode – while sporty 19" Y Spoke (Style 359M) forged alloy wheels reduce unsprung weight. (Shown with a high-tech carbon front air dam, available as a BMW Performance Accessory.)

¹ Driving over rough or damaged road surfaces, as well as debris, curbs and other obstacles, can cause serious damage to wheels, tires and suspension parts. This is more likely to occur with low-profile tires, which provide less cushioning between the wheel and the road. Be careful to avoid road hazards and reduce your speed, especially if your vehicle is equipped with low-profile tires. Performance tires are not recommended for driving in ice and snow conditions. M3 models are not equipped with a spare tire and wheel. Included is the M Mobility System, which offers lifetime BMW Roadside Assistance for tire assistance.



Turn indicators with integrated BMW M3 lettering.



Aerodynamically designed M exterior mirrors.



Illuminated instrumentation in M dashboard with M Drive.



Double Spoke (Style 219M) Bright Silver finish light alloy wheels, 18 x 8.5 front, 18 x 9.5 rear; 245/40 front and 265/40 rear performance tires.¹



Double Spoke (Style 220M) polished and forged light alloy wheels, 19 x 8.5 front, 19 x 9.5 rear; 245/35 front and 265/35 rear performance tires.¹



Y Spoke (Style 359M) bright aluminum finish forged light alloy wheels, 19 x 9.0 front, 19 x 10.0 rear; 245/35 front and 265/35 rear performance tires.¹

Weight		M3 Coupe	M3 Convertible
Unladen weight	lbs	3704	4145
Maximum load	lbs	882	882
Weight distribution, front/rear	%	51.2/48.8	47.2/52.8

Engine		M3 Coupe	M3 Convertible
Liters/cylinders/valves per cylinder		4.0/V-8/4	4.0/V-8/4
Displacement	cu cm	3999	3999
Bore/Stroke	inch	3.62/2.96	3.62/2.96
Maximum output/rpm	hp	414/8300	414/8300
Maximum torque/rpm	lb-ft	295/3900	295/3900
Compression ratio	:1	12.0	12.0

Transmission		M3 Coupe	M3 Convertible
6-speed manual gear ratios I/II/III	:1	4.06/2.40/1.58	4.06/2.40/1.58
6-speed manual gear ratios IV/V/VI/R	:1	1.19/1.00/0.87/3.68	1.19/1.00/0.87/3.68
6-speed manual gear ratios Final drive ratio	:1	3.85	3.85

Performance		M3 Coupe	M3 Convertible
Drag coefficient	C _d	0.31	0.32
Top speed (top speed limited electronically)	mph	155	155
Acceleration 0-60 mph ¹	sec	4.7 [4.5]	5.1 [4.9]

Wheels		M3 Coupe	M3 Convertible
Tire dimensions (performance tires ²)	front	245/40	245/40
	rear	265/40	265/40
Wheel dimensions, front/rear	standard	18 x 8.5 / 18 x 9.5	18 x 8.5 / 18 x 9.5
Material	standard	light alloy	light alloy

Fuel consumption ³		M3 Coupe	M3 Convertible
City	mpg	14 [14]	13 [14]
Highway	mpg	20 [20]	20 [20]
Tank capacity, approximate	gal	16.6	16.6

Brakes		M3 Coupe	M3 Convertible
Front ventilated disc – diameter	inch	14.2	14.2
Rear ventilated disc – diameter	inch	13.8	13.8

Figures in [] reflect 7-speed M Double Clutch Transmission (M DCT) with Drivelogic.

¹BMW AG test results. BMW urges you to obey all posted speed laws and always wear safety belts.

²Driving over rough or damaged road surfaces, as well as debris, curbs and other obstacles, can cause serious damage to wheels, tires and suspension parts. This is more likely to occur with low-profile tires, which provide less cushioning between the wheel and the road. Be careful to avoid road hazards and reduce your speed, especially if your vehicle is equipped with low-profile tires. Performance tires are not recommended for driving in ice and snow conditions. Please note: M3 models are not equipped with a spare tire and wheel. They include M Mobility System, which offers lifetime BMW Roadside Assistance for tire assistance.

³EPA-estimated figures are for comparison purposes only. Your actual mileage will vary, depending on speed, driving habits, trip length and driving conditions; actual mileage may be lower.

BMW M3 Coupe

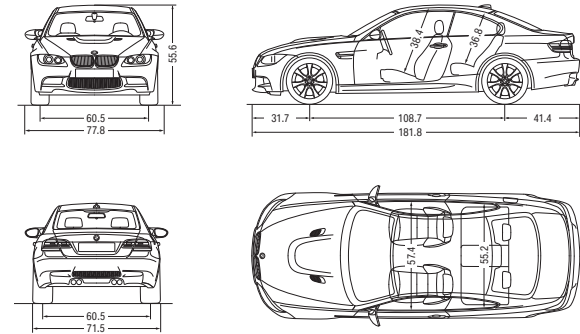

BMW M3 Convertible

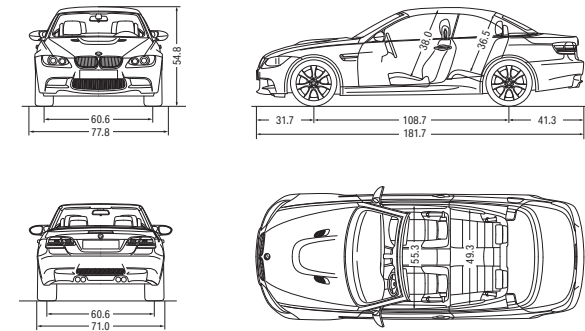

All technical drawing dimensions are shown in inches.

U.S. Importer: BMW of North America, LLC, Woodcliff Lake, NJ 07677. All illustrations and specifications contained in this brochure are based on the latest product information available at the time of printing. BMW reserves the right to make changes at any time, without notice, in colors, materials, equipment, specifications and models. BMW may, subject to legal requirements, determine the Model Year designation of its vehicles. The Model Year designation on any particular model may be longer or shorter than 12 months. Some vehicles pictured may contain non-U.S. equipment. Some models may be shown with optional equipment. While BMW NA makes all reasonable efforts to provide accurate information in this brochure, there is no guarantee or warranty of accuracy. Furthermore, we do not assume any liability for the accuracy or completeness

of information presented. This brochure shall not be used or relied upon as a substitute for information that is available from your BMW center. Further information can be obtained from your authorized BMW center or bmwnusa.com.

©2011 BMW of North America, LLC. Not to be reproduced wholly or in part without written permission of BMW NA. The BMW name, model names and logo are registered trademarks.

The Bluetooth word mark and logos are owned by the Bluetooth SIG, Inc. and any use of such marks by BMW is under license. iPod is a registered trademark of Apple Inc. Other trademarks and trade names are the property of their respective owners.

CRAFT YOUR OWN BMW – AT BMWUSA.COM/BYO.



At BMW, we want you to create your own Ultimate Driving Machine.® That's why BMW offers one of the widest model ranges of any luxury automotive manufacturer. And each BMW model offers its own universe of personalizing possibilities.

It's easy to get the latest information on your favorite BMW model. Simply visit bmwusa.com and click on the BMW model of your choice. Select **"Features & Specs"** to see all the standard features and available options and packages, as well as technical specifications.

Then create the exact BMW model that fulfills your needs by clicking on **"Build Your Own"** – or just visit bmwusa.com/byo. Here you'll be able to select from among the many interior and exterior colors and trims, personalizing options and value-added packages. Build a BMW model that reflects your style, then view it in 360° detail. At the press of a button, see payment and financing options, get a same-day quote, download a product brochure and even schedule a test drive. BMW makes it easier than ever to make your ultimate driving dreams come true, at bmwusa.com.



TAKING IT TO THE NEXT LEVEL: BMW M SCHOOL.

M School, located at the BMW Performance Center in Spartanburg, SC, teaches you what high-performance driving is all about. How to slalom. How to drift. How to push an Ultimate Driving Machine® to the limits. With confidence. You'll learn under the expert guidance of professional driving instructors, while having the time of your life. Get your fill of aggressive handling techniques and advanced braking skills in your choice of One-Day or Two-Day M Schools.

Once you graduate, treat yourself to two full days of Advanced M School. Our professional instructors will teach you things in BMWs that seem to defy physics. We'll take you to Virginia International Raceway, where you'll corner, brake, accelerate and then do it all again. In BMW M Cars. Learn highly technical driving techniques and how to control power. Expect lots of speed. It's intense. It's Advanced M – and it's not for everyone.

For more information on M School and the BMW Performance Center, visit bmwusa.com/performancecenter or call 1-888-345-4BMW(4269).



We believe that a premium ownership experience should feature performance and luxury, as well as safety and convenience. We believe you should be able to drive a BMW to its potential, while enjoying peace of mind and reduced cost of ownership. That's the idea behind **BMW Ultimate Service**[®], a suite of comprehensive programs and services that are included in every new BMW vehicle.

BMW Ultimate Service starts with the **New Vehicle/SAV Limited Warranty**,¹ providing you with coverage for the first four years or 50,000 miles, whichever comes first. Additionally, you have 12-year, unlimited-mileage warranty protection against corrosion and rust perforation.¹ The **BMW Maintenance Program**² and **BMW Roadside Assistance** also come standard, with **BMW Assist**^{TM3} offered as an option.

GOING BEYOND ENGINEERING: THE HIGH-PERFORMANCE BMW OWNERSHIP EXPERIENCE.

BMW Maintenance Program is one of the most comprehensive maintenance programs in its class. We cover all factory-recommended maintenance during the New Vehicle/SAV Limited Warranty coverage period. This includes scheduled oil services and inspections. Also covered is the replacement of items that are subject to normal wear and tear, such as brake pads, wiper blade inserts and engine drive belts.² And, thanks to BMW's advanced engineering, most owners enjoy a well-balanced maintenance schedule, with flexible routine service intervals that can save you time. When your vehicle requires attention, your authorized BMW center ensures that it receives only genuine BMW parts – your assurance of exacting quality standards.

For more details on BMW Ultimate Service and the BMW Maintenance Program, visit your authorized BMW center or log on to bmwusa.com/ultimateservice.

BMW Assist Safety Plan³ is a four-year program that lets you enjoy peace of mind knowing that a friendly response specialist is there to help you, 24/7, at just the push of a button. The Safety Plan includes Automatic Collision Notification, Emergency Request, Enhanced Roadside Assistance, Door Unlock, Stolen Vehicle Recovery and Customer Relations. Included in the BMW Assist Safety Plan, MyInfo allows you to send business locations and street addresses with their associated phone numbers from the Google MapsTM website directly to your BMW. The destination can be sent to your Navigation system for turn-by-turn directions. With the BMW Navigation system and your mobile phone linked to your BMW via Bluetooth[®] technology, BMW's Mobile Office feature⁴ transfers text messages and emails to your iDrive Display screen and reads them aloud to you. A Calendar and To-do List can also appear on your Display screen while en route. Running late? Click on the phone number in the Calendar to call your appointment. For a list of tested mobile phones, visit bmwusa.com/bluetooth.

For the ultimate in coverage, add the optional **BMW Assist Convenience Plan**.⁵ You'll enjoy unlimited access to personalized Directions, Traffic and Weather reports, as well as our Concierge feature, which can send a destination address and phone number, such as a restaurant or hotel, right to your BMW. You can make up to four operator-assisted calls per year with Critical Calling if your cell phone is not available, or if its battery is discharged. BMW Online allows access to up-to-date fuel prices and the latest weather forecasts, as well as Bloomberg's stock indices and the powerful reach of the Google Maps database – delivered to the iDrive Display right inside your vehicle.

BMW's unique **TeleService**, included in the BMW Assist Safety Plan, continually monitors specific parts that are subject to wear and tear – including the engine oil, micro-filter, spark plugs, brake linings and various fluids – as well as services that require attention at regular intervals, such as vehicle service inspections. This data is automatically transmitted to your authorized BMW center, which

will then call you to schedule a service appointment. You don't have to keep track of when your vehicle requires routine maintenance. An added benefit: any needed maintenance service parts will already be on hand, so your BMW is serviced and returned to you as quickly as possible. And because they use only Original BMW Parts, you can rely on expert fit and long-lasting BMW quality. For more details on TeleService, visit bmwassist.com.

BMW Roadside Assistance is provided free of charge for the first four years – with no mileage limit. Call **1-800-332-4BMW (4269)** for friendly on-the-road help, 24/7, anywhere in the United States, Canada and Puerto Rico. This includes everything from flat-tire changes, emergency gasoline and lock-out service, to towing, alternative transportation and even trip-interruption benefits. This service also provides valuable trip-routing advice.



BMW Virtual Center. If you get the sudden urge to shop for a BMW but your authorized BMW center is closed, there's good news – the BMW Virtual Center is open 24 hours a day! Log on to bmwusa.com/byo, and choose the model that interests you. Configure the BMW of your dreams, and see what the monthly payments would be. You can even send the specifications to your authorized BMW center, apply for financing, or request a test drive – all online!

BMW Financial Services. Arranging to buy or lease a BMW is easier than you may think. Your authorized BMW center offers leasing and financing to suit your personal needs through BMW Financial Services.⁶ Start the process at our website, where you can build your "dream vehicle," get an estimate on a monthly lease or financing payment, submit a credit application to BMW Financial Services – and get approval – all online!⁶ To find out how BMW Financial Services can help put you behind the wheel of your favorite BMW model, log on to bmwusa.com/fs or call, toll-free, **1-800-578-5000**.

BMW Magazine. A fascinating view of the latest events and products in the world of BMW, including travel reviews, personality profiles, and the latest BMW technologies. Sent to new owners and lessees several times a year, you can also read articles from **BMW Magazine** on the BMW website at bmwusa.com under the "Media Gallery & Library" heading, found in the "Experience" section.

BMW Welt: The **BMW Welt** ("BMW World") delivery and brand-experience center in Munich is bold proof of BMW's passion for design. When you take advantage of the BMW European Delivery Program,⁷ this is where you will meet your new BMW – in a personalized process that is highly dramatic and totally unforgettable. (You might also realize substantial savings that just may pay for your trip.) While you're there, marvel at the historic BMWs in the Museum; learn about our engineers' newest innovations in the Technology and Design Atelier; and take a tour of the plant to experience firsthand the state-of-the-art methods used to create a BMW. Then comes the unique experience of driving your new BMW on the roads it was designed for. To learn more, visit bmwusa.com/europeandelivery.

¹ See your authorized BMW center for details on these limited warranties.

² The BMW Maintenance Program covers factory-recommended maintenance services as determined by the Service Interval Indicator for all new eligible MY 2004 and later BMW vehicles. Specific additional items that need replacement due to normal wear and tear are also covered. The maintenance coverage period is for the first 4 years or 50,000 miles, whichever comes first. Exclusions from coverage include: gasoline, gasoline additives, windshield washer fluid and additives, battery, tires, wheels, wheel alignment and tire balancing. All work must be performed by an authorized BMW center. See the Service and Warranty Information booklet for specific terms, conditions and limitations. Further information can also be obtained from your authorized BMW center.

³ BMW Assist with 4 years of Safety Plan services is optional or included in the Premium Package. In order to receive BMW Assist services, a subscriber agreement must be completed and transferred to the BMW Assist Response Center. GPS and underlying wireless services must be available and functioning; vehicle ignition must be turned on (except for Door Unlock and Stolen Vehicle Recovery), battery charged and connected and vehicle's electrical system operational; services may be limited to certain geographic areas. Call toll-free **1-888-333-6118**, go to bmwassist.com, or visit your BMW center for additional program details. Services are subject to the terms and conditions of your subscriber agreement.

⁴ Not all mobile phones are compatible with Mobile Office, and some compatible phones support a limited number of Mobile Office functions. For the complete list of compatible mobile phones and the details regarding which Mobile Office functions are supported by each phone, please visit bmwusa.com/bluetooth.

⁵ Requires BMW Assist Safety Plan subscription. Services are subject to the terms and conditions of your subscriber agreement. Please go to bmwassist.com for additional details on the optional Convenience Plan.

⁶ Subject to credit approval and other terms and conditions.

⁷ Not all models available for BMW European Delivery Program. Please go to bmwusa.com or visit your authorized BMW center for details.

THE MOST EXCITING PLACE IN AMERICA TO DRIVE A BMW M VEHICLE.

The BMW Performance Center in Spartanburg, SC.

Just beyond the foothills of the Carolinas' Blue Ridge Mountains lies the \$12 million BMW Performance Center. This sprawling, modern complex houses the world-famous BMW Performance Driving School, as well as the Zentrum Museum, BMW Boutique, BMW Delivery Center, and a Corporate Conference Center. Nearby is BMW's only manufacturing facility in the U.S., where models, such as the X6, X5, and X3, are built for export worldwide. It's a unique place where BMW enthusiasts can spend days – or, in the surrounding area, an entire vacation.

BMW Performance Driving School.

Whether you've been driving for decades or just got your learner's permit, we can help take your driving skills to the next level. Behind the wheel of our new BMWs and under the expert guidance of professional driving instructors, you'll hone your driving skills on a versatile driving course – 1.7 miles of asphalt that can be configured in a multitude of ways. In One- and Two-Day Schools you can tackle the skid pad, slalom course and water walls. The BMW Performance Driving School is about control and pushing a BMW to its limits – and yours.

BMW Performance Center Delivery.

You'll always remember the fun of taking delivery of your new BMW – with BMW Performance Center Delivery. After enjoying dinner and an overnight stay at a first-class hotel, we'll take you and your companion to the Performance Center where a Product Specialist will give you an in-depth introduction to your new BMW. Then at the Performance Driving School, you'll get tips from a professional driving instructor as you explore the dynamic capabilities of a similar model. It's exciting, it's enlightening – and it's all compliments of BMW with your new vehicle.

To learn more about the BMW Performance Center, call **1-888-345-4269** or visit bmwusa.com/performancecenter.

More about BMW



bmwusa.com
1-800-334-4BMW

The Ultimate
Driving Machine®

BMW and the environment.

BMW is a strong proponent of the environment and social responsibility. We launched BMW EfficientDynamics back in 2000 – the philosophy of providing greater power with increased efficiency and fewer emissions. This has resulted in significant benefits today – for our customers, the climate and the environment.

That year, ecological sustainability was also declared one of BMW's core strategic principles; it is now firmly anchored in our entire production chain. It starts with the development of fuel-saving and alternative vehicle concepts, continues with environmentally friendly production processes, and ends with innovative recycling methods. This effort has been recognized worldwide; in 1999, BMW AG – the parent company of BMW of North America and BMW Manufacturing Co. in Spartanburg, SC – was the first automotive company to be represented on the Dow Jones Sustainability Group Index. It has remained on the Index ever since; moreover, since 2005, BMW has been voted the world's most sustainable automobile manufacturer. At BMW, we strive for and achieve high performance in all we do.

BMW recommends  **EDGE**

