

2010 BMW
3 Series Coupe

328i
328i xDrive
335i
335i xDrive



The Ultimate
Driving Machine®



THE BMW 3 SERIES COUPE.

A PASSION FOR FLIGHT.

Contents

2010 BMW 3 Series Coupe

03 | 17 Exterior

18 | 25 Interior

Technology

26 | 27 BMW EfficientDynamics

28 | 29 Engines

30 | 31 Transmissions | Suspension

32 | 33 xDrive | Active safety

34 | 35 Passive safety

36 | 37 BMW ConnectedDrive

Equipment

38 | 41 Paints | Upholsteries | Interior trims | Combinations

42 | 45 Selection examples

46 | 54 Standard | Optional equipment

55 BMW Accessories

56 | 57 Standard safety features

58 | 63 Equipment charts

64 | 65 Technical data

66 | 67 BMW Services

At BMW, we believe that ideas are everything. Because we are an independent company, we have the freedom to make sure that great ideas live on to become Ultimate Driving Machines.®

www.bmwusa.com

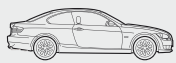
	335i shown with the following equipment:
BMW 335i Coupe	Engine: 24-valve, Advanced Turbo, 3.0-liter, inline six-cylinder
	Wheels: Star Spoke (Style 189) light alloy wheels
	Exterior color: Space Gray Metallic
	Upholstery: Black Dakota Leather
	Interior trim: Aluminum

For details on Standard and Optional equipment, please refer to Equipment Section pages 46-63.

Revolutionary power:
The 3 Series Coupe for 2010.



BMW EfficientDynamics 
Less emissions. More driving pleasure.



**BMW's take on
freedom of
expression.**

Only BMW designers and engineers steeped in motorsport could have produced the 3 Series Coupe – a vehicle that dramatically changes your expectation of the driving experience. Two inline six-cylinder engines achieve faster acceleration and greater torque – but with a reduced thirst for fuel. The ride is equally eye-opening, thanks to a supple suspension that handles tight corners with vigor, while remaining comfortable over long distances. And for the first time in a two-door, BMW offers the all-weather grip of xDrive intelligent all-wheel drive.¹ With its dynamic performance, elegant appointments and outstanding passenger protection, the BMW 3 Series Coupe continues to firmly clinch the title of the world's quintessential Sports Coupe.

¹328i xDrive and 335i xDrive only.



**It will take you from 0 - 60 in 5.3 seconds.¹
It will thrill you even faster.**

¹335i with manual transmission; 5.5 seconds, STEPTRONIC automatic transmission.
BMW AG test results. Obey local speed laws and always wear safety belts.

**Balanced performance: it's what keeps
our cars and our drivers revved for fun.**

Ask any BMW driver what makes a BMW The Ultimate Driving Machine.® You'll learn that it's not just straight-line acceleration, but the way it drives. A BMW's handling is made up of dozens of finely honed performance features—from large, fade-resistant anti-lock brakes to near-perfect 50/50 weight balance—that add up to a legendary car. The 3 Series Coupe takes this formula further with an advanced sport suspension; Dynamic Stability Control (DSC), with unique brake-enhancing features; and one more, often overlooked feature that doesn't enhance performance, but the sheer thrill of driving: the sound of the exhaust. In the 328i, it's a lusty growl. In the 335i, it's a burbly roar upon startup that, as the rpms drop, lowers to a throaty rumble, and when warmed up, idles at a sonorous hum.



Even the newest concepts honor BMW tradition.

The kidney grille: a symbol of BMW's proud heritage. With the 3 Series Coupe, BMW takes a step forward while retaining the design elements that have made it one of the world's most recognized marques.

For example, signature **Corona headlight-rings** encircle all four headlights, serving both as Daytime Running Lights and identifying the vehicle as a BMW at night. Distinctively styled **Xenon Adaptive Headlights** – the outer two headlights – illuminate the road around corners, thanks to an electromechanical control system that directs them into and around the bend as soon as the Coupe begins cornering. The Hofmeister kink – the traditional bend in the C-pillar of every BMW – is edged in chrome, underscoring the dynamic styling of the 3 Series Coupe.

Another classic BMW design: **L-shaped taillights**. The Coupe's styling is further distinguished by horizontal light-conducting rods with LED technology. And **Adaptive Brake Lights** expand the field of your brake lights in sudden stops, alerting drivers behind to maintain a recommended distance.





**Looks that
grab attention.**

**xDrive that
grabs the road.**

Sleek. Aggressive. Captivating. The 3 Series Coupe's crisp performance is matched by its fresh styling. Both reflect the French origin of the word *coupé* — cut. Compared to the Sedan, the roofline is lower; the chiseled front, more sporty. Sharp character lines on the hood and sides mirror the car's bold stance and wind-cheating aerodynamics — on the 328i, a remarkably low C_d of 0.28. Massive 18" light alloy wheels with 225/40 front, 255/35 rear run-flat¹ performance tires² included in the Sport Package increase the 3 Series Coupe's top speed to 150 mph and proclaim its athletic dominance. On smooth, dry roads, xDrive intelligent all-wheel drive — available in the 328i xDrive and 335i xDrive models — gives you a sporty, rear-wheel-drive feel. But hit a wet or snow-covered road, and xDrive automatically sends more torque to the axle with more traction. The 3 Series: a Coupe that's a cut above the rest.

¹Run-flat tires do not come equipped with spare tire.

²Performance tires are not recommended for driving in snow and ice. Due to low-profile tires, please note: wheels, tires and suspension parts are more susceptible to road hazard and consequential damages.

For details on the availability of standard and optional features, please refer to the Standard equipment | Optional equipment charts at the back of this brochure.



**Designed to take your breath away.
Even before you drive it.**



**Designed by BMW for lasting pleasure,
peace of mind and value.**

What does it take to make Car and Driver's coveted 10Best Cars list a record-breaking 18 years in a row?¹ Or have AUTOMOBILE Magazine declare you an All Star for 14 years?² You'll know the moment you drive the 3 Series Coupe. Its pleasures also include a valuable feature unique in the automotive world: BMW Ultimate Service.^{TM3} This package of premium services, warranties and coverage was designed to free you from thinking long and hard before driving your BMW long and hard. At BMW, outstanding value is nothing new: year after year, BMWs have posted among the highest resale values in their class. Drive the 3 Series Coupe and discover a new kind of value you'll look forward to every day.

¹Car and Driver's 10Best Cars, January 1992-2009.

²AUTOMOBILE Magazine All Stars, 1992-1994, 1996-2001, 2003-2004, 2007-2009.

³For full details on BMW Ultimate Service, including exclusions and limitations, see page 66.



335i Coupe shown with the following optional equipment:

- | | |
|-----------------------|---|
| Interior upholstery: | Black Dakota Leather |
| Interior trim: | Aluminum |
| Additional equipment: | Navigation system,
heated seats, rear sunshade |



**The 3 Series Coupe cockpit:
your power connection with the road.**

Efficient, elegant and electrifying, the 3 Series Coupe cockpit is the perfect point of entry into the BMW driving experience. Virtually everything is created to heighten the synchronicity between driver and car. Grab hold of the leather-wrapped sport steering wheel with race-inspired thumb rests, while keeping an eye on the sport-design speedometer and tachometer. Aluminum trim highlights the sleek design. The Navigation system, housed above the center dashboard, guides you to virtually any destination throughout the U.S. This feature includes voice command and iDrive, which allow you to keep your hands on the wheel and your eyes on traffic while changing radio stations, temperature and other comfort settings. Six programmable memory buttons allow you to set your favorite Navigation system addresses, radio stations and phone numbers (if so equipped).

For details on the availability of standard and optional features, please refer to the Standard equipment | Optional equipment charts at the back of this brochure.

**Style that transports
you farther than
your destination:**

The 3 Series Coupe interior.

Does your definition of sophisticated design lean in the direction of sporty or elegant? BMW gives you the freedom to create an interior that reflects your personal style, with a choice of five colors of Dakota Leather upholstery and four handsome interior trims. The front seats are designed for optimal comfort over long distances; those included in the Sport Package offer adjustable side bolsters for more support in high-performance maneuvers. BMW also believes that convenience is an integral part of everyday luxury. That's why, after you settle into the front seat, BMW's unique safety belt assistant automatically brings your safety belt buckle forward to you for easy access. And convenient storage spaces, like the front center console and covered pockets in the front doors, keep loose items secure.

For details on the availability of standard and optional features, please refer to the Standard equipment | Optional equipment charts at the back of this brochure.





Enjoy four seats of first-class accommodations.

With its two supple, supportive seats, generous personal space, luxurious trim, and dramatic lighting, sitting in the rear cabin of the 3 Series Coupe is like relaxing in an exclusive club. But a club that's easy to get into, thanks to an innovative front-seat release and power seat sliding feature. At night, a touch of soft, red Ambiance lighting turns the cabin into a warm space. The center console offers climate controls and convenient storage; two generous cupholders are concealed in the retractable, padded armrest. Both rear seats fold forward, expanding the fully lined trunk's storage capacity. Need even more trunk space? Lift the floor and you'll discover a concealed compartment to stow your valuables.

Smoker's Package/ashtray (shown) not available.

This is how much has gone in.

At BMW, we create dynamic vehicles that thrill you with quick acceleration, predictable handling and unshakable control. We are also busy finding ways to sustain this level of performance while incorporating innovative fuels and technologies to help preserve the environment. This is what we refer to as EfficientDynamics. This goal has led to the visionary CleanEnergy hydrogen-powered engine, which is currently used in the BMW Hydrogen 7 Sedan. BMW Advanced Diesel with BluePerformance, which offers diesel power with quick acceleration, increased fuel efficiency and reduced emissions, was introduced to the U.S. in select models in 2009. In fact, every BMW on the road today comes standard with technology that boosts performance while simultaneously reducing fuel consumption and CO₂ emissions.

Double-VANOS

VANOS is BMW's valve timing system that can steplessly vary the points in the combustion cycle when valves open and close. Double-VANOS refers to the fact that it operates on both the intake and exhaust camshafts. Electronically controlled in response to engine speed, load and temperature, VANOS reduces emissions, and enhances low- to medium-speed torque, as well as fuel efficiency.

Aerodynamics

The more smoothly that air flows over a vehicle, the more efficiently it can operate. All BMWs are designed for a low coefficient of aerodynamic drag, which translates into quicker acceleration, more stable handling, quieter operation and greater fuel efficiency. A BMW's integrated front spoilers reduce the amount of air flowing underneath, minimizing front-end lift. This allows a BMW to hug the road at higher speeds for excellent stability.

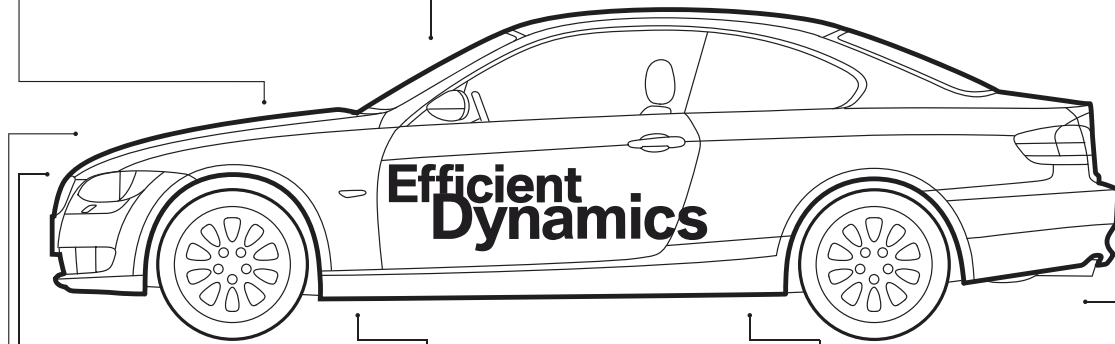

Valvetronic

Instead of using a traditional throttle, Valvetronic technology in the 328i and 328i xDrive lets the engine breathe more easily by varying the lift height of the valves to regulate air intake. The result: improved cold starts, smoother running, and a significant drop in fuel consumption. Using revolutionary technology such as this, BMW has improved its overall average fuel economy more than any other manufacturer.

Efficient transmissions

The 3 Series Coupe offers a choice of two 6-speed transmissions: a smooth-shifting manual, and an equally fuel-efficient STEPTRONIC automatic transmission.

Lightweight construction

Our engineers use lightweight aluminum throughout our vehicles in the front section, for example, or for the suspension. BMW's inline six-cylinder Advanced Turbo engine is all aluminum; the naturally aspirated inline six is an aluminum/magnesium composite the lightest in its class. Taken together, these weight savings lead to lower fuel consumption and better axle load distribution for more agility especially in curves.

Advanced Turbo engine

Benefiting from BMW's Advanced Turbo technology, the 300-hp 335i and 335i xDrive deliver quick acceleration while virtually eliminating turbo lag. Fuel economy is strong, as well, thanks to precise piezo direct fuel injection.

And this is what comes out.

BMW models have low CO₂ emissions today. But that's just for starters. We're carrying on our research in the quest to bring you greater driving pleasure, with fewer emissions and decreased fuel consumption.

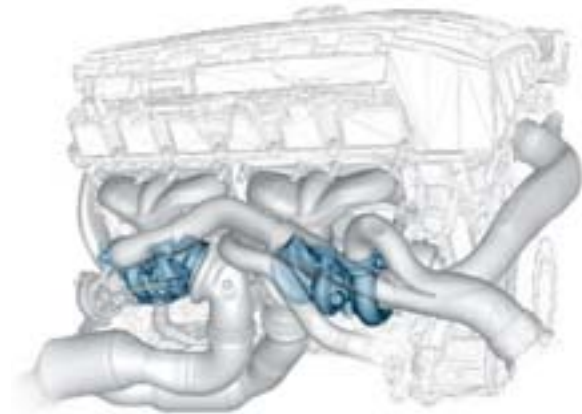

Fast buildup of pressure: the two parallel turbochargers (shown in blue) make a key contribution to the outstanding responsiveness of the 335i inline six-cylinder engine.

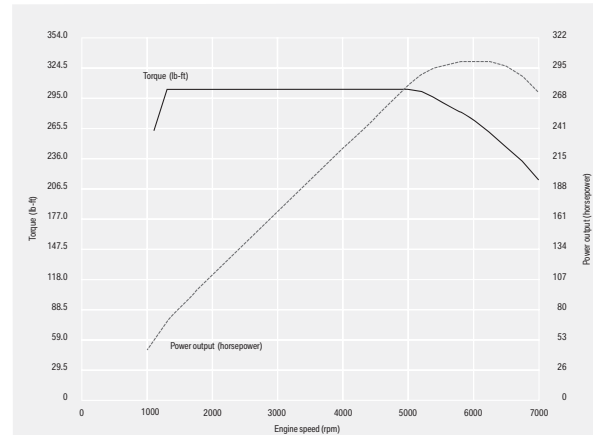

Portrait of an engineering masterpiece: the 335i/335i xDrive Advanced Turbo engine produces 300 hp at 5800 rpm, and quickly develops 300 lb-ft of torque at 1400 rpm, which continues without fading through to the 5000 rpm range. With such a broad range of powerful torque, you can enjoy smooth, robust acceleration in any gear, at any speed.

BMW creates two revolutions in power.

Engines are our passion. That's why a BMW engine does not just deliver power and performance, but it also does so very smoothly and efficiently. It's this refinement that makes our powerplants unique. So it comes as no surprise that we are not the only ones to call our engines refined; they have been receiving accolades and awards from the automotive press for years.

Beneath the long hoods of the 3 Series Coupes lie two of the world's most sophisticated inline six-cylinder engines – and the powerplant in the 335i/335i xDrive is a first in a production BMW: the revolutionary Advanced Turbo. Generating 300 horsepower and 300 lb-ft of torque, this advanced six accelerates with a force that throws you back in your seat and doesn't stop until redline, reaching 60 mph in 5.3 seconds.¹ Turbo lag has been virtually eliminated, thanks to Double-VANOS – steplessly variable valve timing, direct fuel injection, and BMW's inspired use of the latest turbo technology. By using direct fuel injection – a high-precision fuel injection system – our engineers have overcome the traditionally poor gas mileage of turbocharging. Every ounce of fuel is maximized, making the Advanced Turbo engine more efficient. A lightweight aluminum engine block and BMW's

Double-VANOS technology further enhance its smooth power delivery, fuel efficiency, and lowered emissions. All you experience is strong, quick acceleration on demand. And with the engine's inline configuration, the engine runs with a smoothness not possible in a V-6.

Hit the accelerator of the 328i, and in 6.2 seconds² you're sailing past 60 mph, thanks to its 230-hp engine. Advanced Valvetronic technology lets this powerplant breathe better than its predecessor, resulting in greater power, higher torque, quicker engine response, a smoother idle, and enhanced fuel efficiency. The lightweight composite magnesium/aluminum engine block adds to the 328i/328i xDrive's spirited acceleration and nimble handling. And with 200 lb-ft of torque, the power pours on early and strong, and continues throughout the powerband.

The 3 Series Coupes channel their power through a choice of 6-speed transmissions – either a smooth-shifting manual, or STEPTRONIC automatic. Add the automatic transmission and Sport Package or M Sport Package and you will automatically receive steering wheel-mounted paddle shifters for smooth, clutch-free shifting.

¹Manual transmission; 5.5 seconds, STEPTRONIC automatic. 335i xDrive: 5.2 seconds, manual transmission; 5.3 seconds, STEPTRONIC automatic. BMW AG test results.

BMW urges you to obey all posted speed laws and always wear safety belts.

²Manual transmission; 6.8 seconds, STEPTRONIC automatic. 328i xDrive manual: 6.8 seconds; 7.0 seconds, STEPTRONIC automatic. BMW AG test results.

BMW urges you to obey all posted speed laws and always wear safety belts.

For details on the availability of standard and optional features, please refer to the Standard equipment | Optional equipment charts at the back of this brochure.



Six gears are standard.

The BMW 3 Series Coupe comes with your choice of two 6-speed transmissions. The addition of a sixth forward gear gives you sportier acceleration, smoother cruising and better fuel efficiency. The gear ratios are spaced closer together than with a 5-speed, so the transmission has the right ratio for virtually every situation.

A silky-smooth, performance-oriented 6-speed manual transmission is standard. Or choose the 6-speed STEPTRONIC automatic, which offers Adaptive Transmission Control that learns your driving style and shifts accordingly, and a Sport mode for more dynamic shifts. You can also change gears manually: simply select STEPTRONIC mode, then tap the gear lever back to shift up, or forward to shift down, for a more sporting driving experience. The 3 Series Coupe, when equipped with STEPTRONIC automatic transmission and Sport Package or M Sport Package, also comes with steering wheel-mounted paddle shifters.

The Coupe's manual and STEPTRONIC automatic transmissions both offer six forward gears for more dynamic and efficient driving.

For details on the availability of standard and optional features, please refer to the Standard equipment | Optional equipment charts at the back of this brochure.



The 3 Series Coupe suspension: Always in touch with the road and shields you when the road plays rough.

One of the major ingredients in a BMW's uncommonly agile handling is the suspension. To make the most of the 3 Series Coupe's prolific power, BMW engineers incorporated the double-pivot front suspension currently used in the 5, 6 and 7 Series. This system uses two lower arms instead of one, working in combination with the spring/shock-absorber strut. This sport-tuned system delivers best-in-class steering feel and control, tight cornering, enhanced straight-line stability, and improved ride comfort, even on rough road conditions. On rear-wheel drive models, many components are made of aluminum for reduced unsprung weight. Another bonus: the double-pivot front suspension easily accommodates the Coupe's enlarged brakes.

The 3 Series Coupe's 5-link rear suspension gives the rear wheels more precise control for handling that is sporty and, at the same time, stable and predictable. Since all five links are connected to the subframe and not the body, any road roughness is kept from the passenger cabin. Light and remarkably compact, this rear suspension leaves more room for increased trunk space. And, compared to its predecessor's rear suspension design, the 3 Series Coupe is even better at managing the energy from a rear impact—an important passive safety feature.

The 3 Series Coupe's sport-tuned double-pivot front suspension delivers amazingly agile, sporty handling in corners. On rough roads, the handling remains stable and comfortable.



xDrive all-wheel drive gives you the power to master virtually anything the road throws at you.

BMW's xDrive intelligent all-wheel-drive system¹ takes all-road traction to exhilarating heights, while maintaining the 3 Series' agility. On smooth, dry roads, the 328i xDrive and 335i xDrive have the feel of their rear-wheel-drive counterparts. But hit a wet uphill curve, for instance, and even before wheelspin can occur, the xDrive system recognizes any need for a change in power distribution. Almost

instantaneously, xDrive can send more torque to the front axle in order to enhance stability. Should one wheel on an axle spin faster than the other, the brakes automatically engage as needed, to bring all wheels back in sync. At any given moment, xDrive is working hard, shifting drive power, reducing over- or understeer, enhancing agility, and providing the best possible traction.

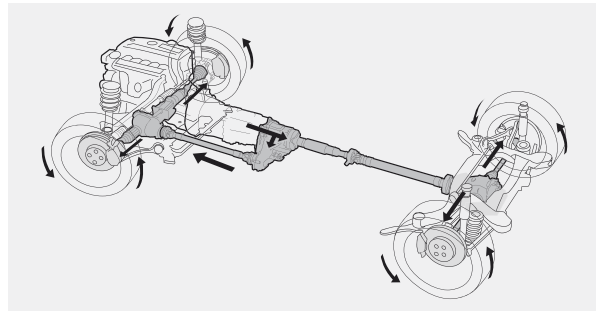

By using readings from the Dynamic Stability Control sensors and the gas pedal, xDrive all-wheel drive monitors the car's driving condition. This data is then used to vary power distribution between the two axles, helping to ensure agile, neutral and forgiving handling.

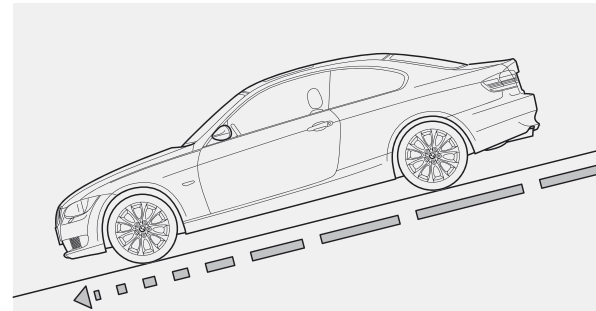

Hill Descent Control (HDC) in the 328i xDrive and 335i xDrive models helps you drive down steep hills without having to ride the brake pedal. Simply press the HDC button and the vehicle's speed is kept under control automatically.

It's reassuring to know that your brakes were also designed for the Autobahn.

BMW firmly believes that powerful brakes are just as important as a powerful engine. That's why the 3 Series Coupe is equipped with four large ventilated anti-lock disc brakes, as well as BMW's Dynamic Stability Control (DSC) system. DSC monitors wheelspin to help keep the vehicle under control and headed in your intended direction. If your BMW begins to slide, DSC intervenes by reducing engine power and braking each wheel individually and independently, to help your BMW regain its footing.

Brake Fade Compensation: When descending steep roads, brakes heat up from continuous and repeated braking. This reduces braking power. DSC senses and compensates for this by applying the brakes with more force, letting you use the same pressure on the brake pedal as before.

Start-off Assistant: This feature helps prevent your vehicle from rolling backwards when stopping on a hill, and holds your car momentarily as you release the brake to start moving again.

This important active safety system also includes four features:

Brake Drying: When a sensor detects that it is raining, this DSC function works to eliminate accumulated moisture by bringing the brake pads into contact with the rotors to help dry them.

Brake Stand-by: If you suddenly remove your foot from the throttle, DSC anticipates you want to stop quickly, and pre-tenses the brake calipers for quicker action when you apply the brakes.

BMW's are also equipped with **Dynamic Brake Control**, which is designed to help you stop more quickly during emergency braking. Your BMW measures how quickly and forcefully you step on the brake pedal. When it detects fast, hard emergency braking, the system immediately applies the maximum available braking power.

Sudden bends in an unfamiliar road can make for challenging driving. But changing weather conditions can turn even the most familiar street into an obstacle course. xDrive¹ all-wheel drive and Dynamic Stability Control are always at work, helping to keep your BMW stable, responsive and controllable at all times. This is what BMW calls active safety.

¹xDrive standard in 328i xDrive and 335i xDrive; not available in 328i and 335i.



High performance can be moving in more ways than one.

Performance is a passion of BMW engineers – especially safety engineers. The 3 Series Coupe has the power, the handling, and the brakes to help you avoid accidents. But not all collisions are avoidable. That's why the Coupe is equipped with an advanced system of safety belts and airbags that deploy in a split-second when the sensors detect an impact. Optional BMW Assist™ summons help automatically in the event of a serious accident; it can also be used to call for Roadside

Assistance.¹ From the award-winning Head Protection System to the Battery Safety Terminal, the 3 Series Coupe includes dozens of passive safety features, all designed to help protect you and your passengers. Like every facet of the vehicle, they also belong under the heading of high performance.

¹ See page 66 for details on BMW Assist.



The 3 Series Coupe's extremely stiff passenger cell, safety belt system, driver and front passenger airbags at front and sides, and Head Protection System front and rear work together to help provide excellent protection in an impact.

Please note: These pictures of airbags are for illustrative purposes only. Depending upon the type of accident, none, some or all airbags may deploy.



When an upcoming service need is detected, your BMW automatically transmits all relevant information to your BMW Service Advisor, who then contacts you to arrange an appointment.

Select not only the fastest, but also the most interesting roads to reach your destination.

Heading for a traffic jam? **Real Time Traffic Information** lets you know in advance and recommends an alternative route.

Get into a serious accident? Your BMW automatically calls for help and communicates all relevant information.

All drivers sometimes need to stop and refuel. Let a **BMW Assist™** Concierge locate and send the address of your preferred gas station and the best local restaurant to your BMW.

Need an address or phone number? **BMW Search™** uses **Google Maps™** to find them, then the Navigation system directs you there.

Find many more ways how **BMW Assist** makes every trip you take more enjoyable.



MyInfo allows you to send business locations and street addresses to your BMW from your computer. Destinations and phone numbers can be accessed and exported to your Navigation system for immediate route guidance, while you can call the destination with your Bluetooth® linked phone.



BMW Search allows online access to up-to-date fuel prices, the latest weather forecasts, Bloomberg stock indices and the powerful reach of the Google Maps database delivered on your control display inside your vehicle.



In most large cities, **Real Time Traffic Information** makes you aware of traffic congestion before you encounter it. This feature displays and describes current local traffic information on your control display; in case of congestion, it suggests alternate routes.



BMW is the first automobile manufacturer to offer **BMW Trips**, giving you the opportunity to directly transfer personally planned trips from the Internet to your Navigation system via a USB memory stick. (Delayed availability.)

Two for the road: Navigation and BMW Assist

When you're far from home or just in the next town, it's easy to find your way with confidence and peace of mind with the convenient features and services available on your BMW.

BMW Assist Safety Plan gives you peace of mind knowing that a friendly response specialist is there to help you 24/7, at the touch of a button. Enjoy four years of a wide range of services at no additional charge. The Safety Plan includes Automatic Collision Notification, Emergency Request (SOS), TeleService, Enhanced Roadside Assistance, Door Unlock, Stolen Vehicle Recovery, Customer Relations and MyInfo.

The **BMW Assist Convenience Plan** adds personalized Directions, Traffic and Weather reports, BMW Search and Concierge services to not only recommend restaurants and hotels, but then also send the destination address and phone number right to your BMW. You can make up to four operator-assisted calls per year with Critical Calling if your cell phone is not available or its battery is discharged.



Exterior Paints

300 Alpine White Non-metallic

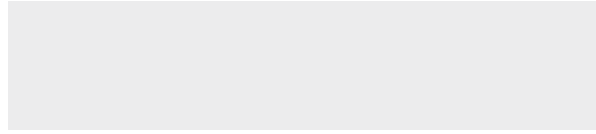

A61 Crimson Red Non-metallic



668 Jet Black Non-metallic



354 Titanium Silver Metallic

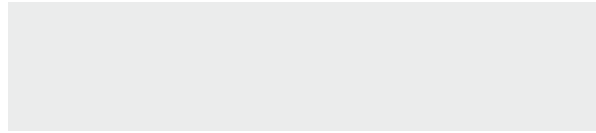

A53 Platinum Bronze Metallic



896 Blue Water Metallic



A52 Space Gray Metallic



A17 Mojave Metallic



A13 Atlantic Blue Metallic



A51 Montego Blue Metallic



A35 Monaco Blue Metallic



381 Le Mans Blue Metallic (requires M Sport Package)



A39 Barbera Red Metallic



A81 Tasman Green Metallic



475 Black Sapphire Metallic



The pages in this section show available colors and materials for the BMW 3 Series Coupe. Use these samples to compare paint, upholstery, trim colors and combinations. Please note that these samples are representations; they are not exact reproductions. To see the actual colors, visit your local BMW center or bmwusa.com/byo

Please refer to the Combinations chart on page 41 for details on limitations and exclusivity when selecting 3 Series Coupe exterior paint colors and upholstery materials and colors.

Upholstery colors and materials

KAGE Cream Beige Leatherette



KASW Black Leatherette



LCGE Cream Beige Dakota Leather



LCAD Gray Dakota Leather



LCD1 Coral Red/Black Dakota Leather



LCD3 Saddle Brown/Black Dakota Leather



LCSW Black Dakota Leather

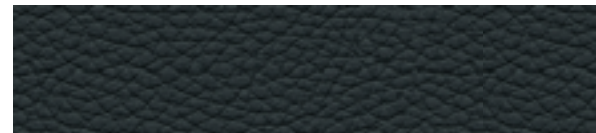

Please refer to the Combinations chart on the facing page for details on limitations and exclusivity when selecting 3 Series Coupe interior trims.

Interior trims

4AB Dark Burl Walnut Wood



4A3 Light Burl Walnut Wood



4AS Gray Poplar Wood



4B9 Aluminum Trim



4MG Glacier Silver Aluminum (requires M Sport Package)



Recommended color combinations

Materials	Leatherette ¹		Dakota Leather ²				
	Cream Beige	Black	Cream Beige	Gray	Coral Red/Black	Saddle Brown/Black	Black
Upholstery color							
Exterior colors							
300 Alpine White Non-metallic ¹		•	•	•	•	•	•
A61 Crimson Red Non-metallic ^{1, 3}		•	•	•	•	•	•
668 Jet Black Non-metallic ^{1, 3}		•	•	•	•	•	•
354 Titanium Silver Metallic ⁴			•		•		•
A53 Platinum Bronze Metallic ^{3, 4}		•	•	•	•		•
896 Blue Water Metallic ⁴		•	•	•	•		•
A52 Space Gray Metallic ⁴		•	•	•	•	•	•
A17 Mojave Metallic ^{3, 4}		•	•	•	•		•
A13 Atlantic Blue Metallic ^{3, 4}		•	•	•	•		•
A51 Montego Blue Metallic ^{3, 4}		•	•	•	•		•
A35 Monaco Blue Metallic ^{3, 4}		•	•	•	•		•
381 Le Mans Blue Metallic ⁵		•	•	•	•		•
A39 Barbera Red Metallic ^{3, 4}		•	•	•	•		•
A81 Tasman Green Metallic ^{3, 4}		•	•	•	•		•
475 Black Sapphire Metallic ⁴		•	•	•	•	•	•
Interior trims							
4AB Dark Burl Walnut Wood ¹		•	•	•	•	•	•
4A3 Light Burl Walnut Wood ⁶		•	•	•	•	•	•
4AS Gray Poplar Wood ⁶		•	•	•	•	•	•
4B9 Aluminum Trim ⁶		•	•	•	•	•	•
4MG Glacier Silver Aluminum ⁵		•	•	•	•	•	•

¹ Standard in all models.
² Optional in all models and included with Premium Package.
³ Not available with M Sport Package.
⁴ Optional in all models.
⁵ Optional; requires M Sport Package.
⁶ No-cost option in all models.

Updated classic.

The sporty sophistication of the Mojave Metallic exterior is complemented by classic Black Dakota Leather upholstery with the elegant Light Burl Walnut Wood trim. The result: an energizing look with a private club feel. [bmwusa.com/byo](https://www.bmwusa.com/byo)

See page 41 for detailed information regarding Paints, Upholsteries and Interior trims.



The warm interior creates a vibrant counterpart to the sporty Mojave Metallic exterior with Star Spoke (Style 157) light alloy wheels.



328i Coupe shown with the following equipment:

Exterior color:	Mojave Metallic
Interior upholstery:	Black Dakota Leather
Interior trim:	Light Burl Walnut Wood
Additional equipment:	Star Spoke (Style 157) light alloy wheels, STEPTRONIC automatic transmission, Park Distance Control, Navigation system



Cool elegance.

Like cool jazz, the combination of an Atlantic Blue Metallic exterior with Cream Beige Dakota Leather and Gray Poplar Wood interior is understated, yet totally assured.

See page 41 for the Recommended color combinations chart.



328i xDrive Coupe shown with the following equipment:

Exterior color:	Atlantic Blue Metallic
Interior upholstery:	Cream Beige Dakota Leather
Interior trim:	Gray Poplar Wood
Additional equipment:	Star Spoke (Style 185) light alloy wheels, Sport Package



Light and inviting, the interior is an immediate mood elevator.





■ **Xenon Adaptive Headlights** provide brilliant clarity of the road ahead and to the side at night and in conditions with poor visibility. The dynamic auto-leveling feature adjusts for varying passenger and cargo loads, helping to keep headlight glare out of the eyes of oncoming drivers. BMW Adaptive Headlights provide optimum road illumination around corners, thanks to an electromechanical control system that directs the headlights into and around the bend as soon as the vehicle begins cornering. The Corona headlight-rings that circle both headlights and high beams also act separately as Daytime Running Lights and parking lights.



■ **Halogen free-form foglights**, integrated into the deep front spoiler, enhance your margin of safety in bad visibility. Ellipsoid free-form technology ensures even light distribution on the road.



■ **Adaptive Brake Lights** increase vehicle visibility and signal the intensity of your braking action.



■ BMW's **distinctive front kidney-shaped grille** features a chrome surround and vertical slats on all 3 Series Coupes.



■ **Roof rail clips and grooves** are designed for the BMW Accessory roof rail system, holding it perfectly in place.



□ **Star Spoke (Style 230)** light alloy wheels and **run-flat¹ performance tires²**. In front: 19 x 8.0 wheels with 225/35 tires; in back: 19 x 9.0 wheels with 255/30 tires.³ (Optional on 335i, requires Sport Package.)



□ **Star Spoke (Style 189)** light alloy wheels with **run-flat¹ performance tires²**. In front: 18 x 8.0 wheels with 225/40 tires; in back: 18 x 8.5 wheels with 255/35 tires.³ (Included in 335i Sport Package; optional on 335i xDrive, requires Sport Package.)



■ **Star Spoke (Style 157)** 17 x 8.0 light alloy wheels with 225/45 **run-flat¹ all-season tires**. (Standard on 328i/328i xDrive.)



■/□ **Star Spoke (Style 185)** 17 x 8.0 light alloy wheels with 225/45 **run-flat¹ all-season tires**. (Standard on 335i/335i xDrive; included in 328i xDrive Sport Package.)



□ **V Spoke (Style 188)** 17 x 8.0 light alloy wheels with 225/45 **run-flat¹ all-season tires**. (Included in 335i xDrive Sport Package.)



□ **Cross Spoke (Style 197)** light alloy wheels with **run-flat¹ performance tires²**. In front: 18 x 8.0 wheels with 225/40 tires; in back: 18 x 8.5 wheels with 255/35 tires.³ (Included in 328i Sport Package; optional on 328i xDrive, requires Sport Package.)

¹Run-flat tires do not come equipped with a spare tire.

²Performance tires not recommended for driving in ice and snow.

³Due to low-profile tires, wheels, tires and suspension parts are more susceptible to road hazard and consequential damages.



□ **Steering wheel-mounted paddle shifters** allow you to shift gears manually without a clutch. This feature comes included in the 3 Series Coupe when it is equipped with STEPTRONIC automatic transmission and Sport Package or M Sport Package.



■ **6-speed manual transmission** for a very sporty drive. Smooth, with perfect ratios and precise, short-throw gearshifts. The addition of a 6th gear and the reduced spacing of gear ratios mean that you can make even more individual use of the engine power.



□ **6-speed STEPTRONIC automatic transmission** provides a choice of three modes: **Drive** with Adaptive Transmission Control; a more dynamic **Sport** mode; and STEPTRONIC automatic, for the hands-on control of a manual without a clutch.¹

¹ When STEPTRONIC automatic transmission and Sport Package or M Sport Package are ordered, steering wheel-mounted paddle shifters are automatically included.



□ **Logic7 Surround Sound anti-theft AM/FM stereo CD/MP3 player audio system** provides outstanding sound with 13 speakers and the adjustable surround sound function to create a luxurious soundscape all around you. The subwoofer speakers are in the door sill and produce an authentic bass sound.



■ **Auxiliary input port** lets you connect an external audio source, such as an iPod® or MP3 player.
 □ **USB/audio interface** enables connection of a USB stick. Music titles stored on this are displayed on the radio or Navigation screen and can be selected using the multi-function buttons on the steering wheel, or via the iDrive Controller.



■ **Eight-way adjustable front seat²** (including two-way manually adjustable headrest) is designed and bolstered to provide excellent support and comfort. (Shown with iDrive, which is included with Navigation system.)

² Six-way adjustable front passenger seat standard in 328i models; eight-way adjustable standard in 335i models, along with power seats, and driver memory with two pre-sets for seat and exterior mirrors.



■ **Storage compartments** are integrated into both doors. A tilt-out bin below the armrest offers different compartments in which to tuck away sunglasses, change and other small items; a convenient open storage space for maps and larger items is just behind it.



■ **Automatic safety belt assistant** for the two front seats makes buckling up easier by bringing the belt forward whenever you get into the vehicle. As soon as the safety belt is clicked, the arm retracts into its housing. (If the safety belt for an occupied seat isn't used, the arm retracts after one minute or as soon as the vehicle reaches a speed of about 4 mph.)



■ **HD Radio™** receives free, digital AM/FM broadcasts across the U.S. in clear, static-free quality sound. AM sounds like FM; FM sounds like CD. Also enjoy new multicast FM stations, as well as a variety of innovative data services. Can be ordered with Logic7 Surround Sound audio system.

For more information on HD Radio receivers and to find HD Radio AM/FM stations near you, visit HDRadio.com.



■ **Dynamic Cruise Control** lets you store and keep to a chosen speed above 20 mph, automatically applying the brakes downhill. It is activated via the left-hand steering column switch, and deactivated by applying the brakes or via the switch³

³ Cruise Control is not a substitute for the driver's own responsibility in adjusting speed and otherwise controlling the vehicle. After evaluating road, traffic and visibility conditions, the driver decides whether and how the system is used.



■ **Rear Console** provides rear-seat occupants with ample storage, both open and covered, and climate controls for rear-cabin airflow rate and temperature. The center fold-down armrest contains two retractable cupholders.



■ **Rear fold-down seats** allow you to load long objects in the trunk by folding down one or both rear seats, as needed.



■ **BMW Ambient Lighting** adds a touch of elegance to cabin lighting. In addition to soft, white light, turn the headlights on to enjoy the drama of a warm reddish light that runs from front to rear beneath the inner door ledge.



■ **Engine Start/Stop button⁴ and remote key** control the engine. First, insert the remote key into the starter switch slot. After the electronic identification system confirms that it is the correct remote key, you can start (or later, turn off) the engine by pressing the Start/Stop button.

⁴ Foot must be on brake or, with manual transmission, must also depress the clutch in order to start.



■ **The on-board computer** with Check Control provides valuable feedback on the vehicle's operating status: oil level indicator and distance to next service appointment/oil change, as well as other detailed information, such as spark plug and micro-filter status. It also provides travel information: travel range on remaining fuel, external temperature, and more.



□ **Two-way power glass moonroof** with remote, expanded one-touch operation, slides forward or tilts up to let in as much fresh air and sky as you like, while a wind deflector helps keep the wind out. Includes a sliding interior sunshade.



□ **Active Cruise Control** allows the driver to set a desired speed that is automatically maintained in free-flowing traffic. However, as the 3 Series Coupe approaches a slower-moving vehicle ahead, a radar sensor in the front bumper alerts the system. Active Cruise Control will then act to match the speed of the slower vehicle, and remain a set distance behind, pre-selected by the driver. As soon as the lane ahead is clear, Active Cruise Control automatically returns the car to the set speed.¹

¹ Active Cruise Control is not a substitute for the driver's own responsibility in adjusting speed and otherwise controlling the vehicle. After evaluating road, traffic and visibility conditions, the driver decides whether and how the system is used.



□ **Park Distance Control** uses ultrasonic sensors in the rear bumper to help you judge the distance to other cars and unseen objects when parking. The beeping becomes faster as your bumper approaches the object, turning into a constant tone when the distance is less than 12 inches.

Shown with Navigation system.



□ **BMW Assist™²** and Bluetooth® system offers hands-free calling through your BMW-approved Bluetooth phone. The BMW Assist Safety Plan is included for four years, providing Automatic Collision Notification. (Optional and included in Premium Package.)

² The optional Convenience Plan offers Directions, Traffic, Weather, Critical Calling and Concierge services. See page 66 for detailed information on standard and optional services.



□ **Power sun shade for the rear window** can be conveniently raised and lowered. This feature helps eliminate glare, maintains occupant privacy, and helps keep the cabin temperature pleasant by reflecting intense sunlight.



□ **Comfort Access system** offers convenient keyless access to your car. Simply carrying the remote key in a pocket or purse allows you to unlock the doors by touching the door handle. You can also turn the engine on or off by pressing the Start/Stop button³ without inserting the remote key.

³ Foot must be on brake or, with manual transmission, must also depress the clutch in order to start.

Premium Package

Add immeasurably to the enjoyment of your 3 Series Coupe with the Premium Package. Eight-way power-adjustable⁴ front seats, upholstered in supple Dakota Leather, offer the customized comfort of four-way adjustable lumbar support and the convenience of seat and exterior mirror memory. At night you'll appreciate the enhanced visibility afforded by the auto-dimming feature of the power-adjustable, folding exterior side-view mirrors, and interior rear-view mirror with digital compass. BMW Assist offers road-going peace of mind, while Bluetooth wireless technology lets you make and receive calls without taking your eyes from the road.⁵ And the integrated three-button Universal garage-door opener takes the place of up to three separate remote-control devices, helping to eliminate clutter.

⁴Power-adjustable front seats standard in 335i models.

⁵Requires BMW-approved Bluetooth enabled phone.



Lumbar support for front seats adds four-way adjustable comfort for the lower back. Lumbar support can be adjusted up/down and in/out.



Luxurious leather upholstery cradles driver and passengers in softly gathered comfort. Durable and easy to maintain, a leather interior adds elegance and refinement.

Shown with Saddle Brown Dakota Leather upholstery, Dark Burl Walnut Wood trim, and Navigation system.



Two-way power glass moonroof with remote, expanded one-touch operation, slides forward or tilts up to let in as much fresh air and sky as you like, while a wind deflector helps keep the wind out. Includes a sliding interior sunshade.



BMW Universal garage-door opener takes the place of up to three remote-control devices. It can activate remote functions outside the vehicle, such as garage-door openers or home-lighting systems. Also shown: the **auto-dimming rear-view mirror** with digital compass.



BMW Assist⁶ and Bluetooth system offers hands-free calling through your BMW-approved Bluetooth phone. The BMW Assist Safety Plan is included for four years, providing Automatic Collision Notification, Emergency and Roadside Assistance, Door Unlock, Stolen Vehicle Recovery, TeleService and more.

⁶ The optional Convenience Plan offers Directions, Traffic, Weather, Critical Calling and Concierge services. See page 66 for detailed information on standard and optional services.

Cold Weather Package

Enjoy winter to the fullest with the Cold Weather Package. There's nothing like the feeling of a heated steering wheel and quick-warming heated front seats on a chilly morning or the reassurance of clean, bright headlights¹ on a stormy night. And for those en route to the slopes, a ski bag neatly holds skis and ski poles.

¹High-intensity headlight washers standard on 328i xDrive and 335i xDrive models.



Retractable **high-intensity headlight washers** help keep lights clean of ice, mud, road salt and other coatings, for maximum road lighting and enhanced driving safety.



Heated steering wheel is a feature that, like heated seats, becomes a must-have once it's experienced. The heating switch is conveniently located on right-hand side of the steering column.



Ski bag allows clean and secure transport of up to four pairs of skis and ski poles. When the ski bag is not extended, the center armrest can be left down for use or folded up.



Heated front seats are a welcome feature for driver and front passenger in cooler weather. With the touch of a button, seat surface and backrest are heated and quickly radiate comfortable warmth in your choice of three settings.

Sport Package

The Sport Package's larger wheels and run-flat² performance tires³ add to the excitement of the 3 Series Coupe. Specially bolstered sport seats hold you firmly in place during sporty driving maneuvers and cradle you comfortably over long distances. When equipped with the Sport Package and optional STEPTRONIC automatic transmission, the 3 Series Coupe also comes with steering wheel-mounted paddle shifters.

²Run-flat tires do not come equipped with a spare tire.

³Run-flat performance tires are optional in xDrive models with Sport Package. Performance tires not recommended for driving in ice and snow. Due to low-profile tires, please note: wheels, tires and suspension parts are more susceptible to road hazard and consequential damages.



Shadowline trim gives a sporty look to front and rear side-window frames, window recess finishers, and door-sill trim strips.



Cross Spoke (Style 197) light alloy wheels with **run-flat² performance tires**.³ In front: 18 x 8.0 wheels with 225/40 tires; in back: 18 x 8.5 wheels with 255/35 tires. (328i Sport Package; optional on 328i xDrive, requires Sport Package.)



Star Spoke (Style 185) 17 x 8.0 light alloy wheels with 225/45 **run-flat² all-season tires**. (328i xDrive Sport Package.)



V Spoke (Style 188) 17 x 8.0 light alloy wheels with 225/45 **run-flat² all-season tires**. (335i xDrive Sport Package.)



Star Spoke (Style 189) light alloy wheels with **run-flat² performance tires**.³ In front: 18 x 8.0 wheels with 225/40 tires; in back: 18 x 8.5 wheels with 255/35 tires. (335i Sport Package; optional on 335i xDrive, requires Sport Package.)



Star Spoke (Style 230) light alloy wheels with **run-flat² performance tires**.⁴ In front: 19 x 8.0 wheels with 225/35 tires; in back: 19 x 9.0 wheels with 255/30 tires. (Optional on 335i, requires Sport Package.)

⁴Performance tires not recommended for driving in ice and snow. Due to low-profile tires, please note: wheels, tires and suspension parts are more susceptible to road hazard and consequential damages.



Eight-way adjustable front sport seats with two-way manual headrests and thigh support make the driving experience more enjoyable. Side bolsters can be power-adjusted to fit your back comfortably while helping to hold you firmly in place during cornering. (328i models require power seats or Premium Package.)

Shown with Coral Red Dakota Leather upholstery, Brushed Aluminum interior trim, and Navigation system.

M Sport Package

An Aerodynamic package and increased top-speed limiter hint at the package's performance-oriented attitude. Exclusive to the M Sport Package is the choice of Le Mans Blue Metallic paint, set off by shadowline trim and gleaming Star Spoke (Style 193M) 18" M light alloy wheels with 225/40 front, 255/35 rear run-flat performance tires.¹ The 335i Coupe also offers the choice of Double Spoke (Style 225M) 19" M light alloy wheels with 225/35 front, 255/30 rear run-flat performance tires.¹ The interior boasts sport seats and a leather-wrapped M multi-function sport steering wheel²; an Alcantara headliner, M door sills and an M footrest add an expressive visual touch.



The **Aerodynamic kit** includes a front air dam with generous air intakes, dynamic side skirts and an athletic rear spoiler.



Rear apron not only adds to the sporty look of the 3 Series Coupe, it helps reduce drag at higher speeds.



Star Spoke (Style 193M) M light alloy wheels with run-flat performance tires.¹ In front: 18 x 8.0 wheels with 225/40 tires; in back: 18 x 8.5 wheels with 255/35 tires.



Three-spoke, leather-wrapped multi-function M sport steering wheel² is included in the M Sport Package. With the traditional M logo in the center spoke, the visually attractive wheel features multi-function buttons allowing you to keep both hands on the wheel while adjusting various comfort functions.



Park Distance Control uses ultrasonic sensors in the rear bumper to help you judge the distance to other cars and unseen objects when parking. The beeping becomes faster as your bumper approaches the object, turning into a constant tone when the distance is less than 12 inches.

Shown with Navigation system.



Eight-way adjustable front sport seats make the driving experience more enjoyable. Side bolsters can be power-adjusted to fit your back comfortably while helping to hold you firmly in place during cornering. Includes two-way manual headrests and thigh support.

¹ Run-flat tires do not come equipped with a spare tire. Due to low-profile tires, please note: wheels, tires and suspension parts are more susceptible to road hazard and consequential damages. Performance tires not recommended for driving in ice and snow.

² When STEPTRONIC automatic transmission is ordered with the M Sport Package, steering wheel-mounted paddle shifters are automatically included.

An easy way to make life immediately more enjoyable: Original BMW Accessories.



Aerodynamic kit; Star Spoke (Style 179) 19" light alloy composite wheels with a titanium bolt design.

If driving a BMW adds to the quality of life, Original BMW Accessories personalize the pleasure. Want to set your BMW apart? Add unique wheels, sporty aerodynamic components, or even an elegant wood gearshift knob. Do you lead an active life? BMW roof rack systems let you easily transport bikes, skis, snowboards and more. From start (Advanced Battery Charging System) to finish (BMW Car Care

Products), Original BMW Accessories turn your BMW into a sporty, practical and even luxurious reflection of yourself.

For detailed information on ordering Original BMW Accessories, please contact your authorized BMW center. Some details shown in photographs may not be available in the United States.



Rear deck spoiler in body color intensifies the look of power and performance.



Stainless-steel pedal pads, illuminated door sills and tailored floor mats add elegant accents in the footwell.



Snap-in adapter plays stored music, charges the phone and accesses the car antenna.

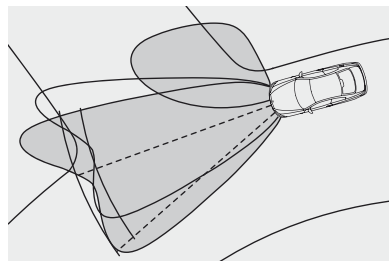

Xenon Adaptive Headlights illuminate the road ahead and to the side with brilliant clarity; Xenon headlights also have a dynamic auto-leveling feature. **BMW Adaptive Headlights** illuminate the road around corners by directing the headlights into and through the bend, as soon as the vehicle begins cornering.

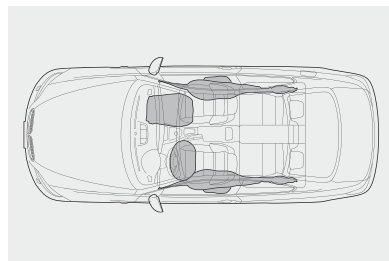

In the event of a collision, BMW's supplemental restraint system (SRS) with advanced technology for the driver and passenger front **airbags** determines which airbags to deploy for optimal protection. The system also includes front seat-mounted side-impact airbags and front-to-rear Head Protection System (HPS) airbags.

Please note: These pictures of airbags are for illustrative purposes only. Depending upon the type of accident, none, some or all airbags may deploy.

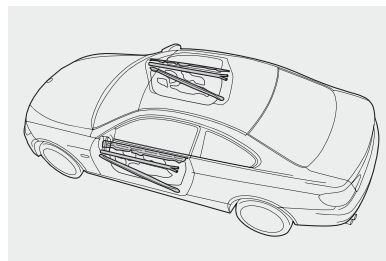

BMW's door-anchoring system includes a reinforcing bar with a hook-like member within each door. In a severe side impact, the reinforcing bar hooks the door to the body, locking them together to make a more rigid passenger cell. When the pressure is released, the anchoring system is designed to snap back so that the doors can open.

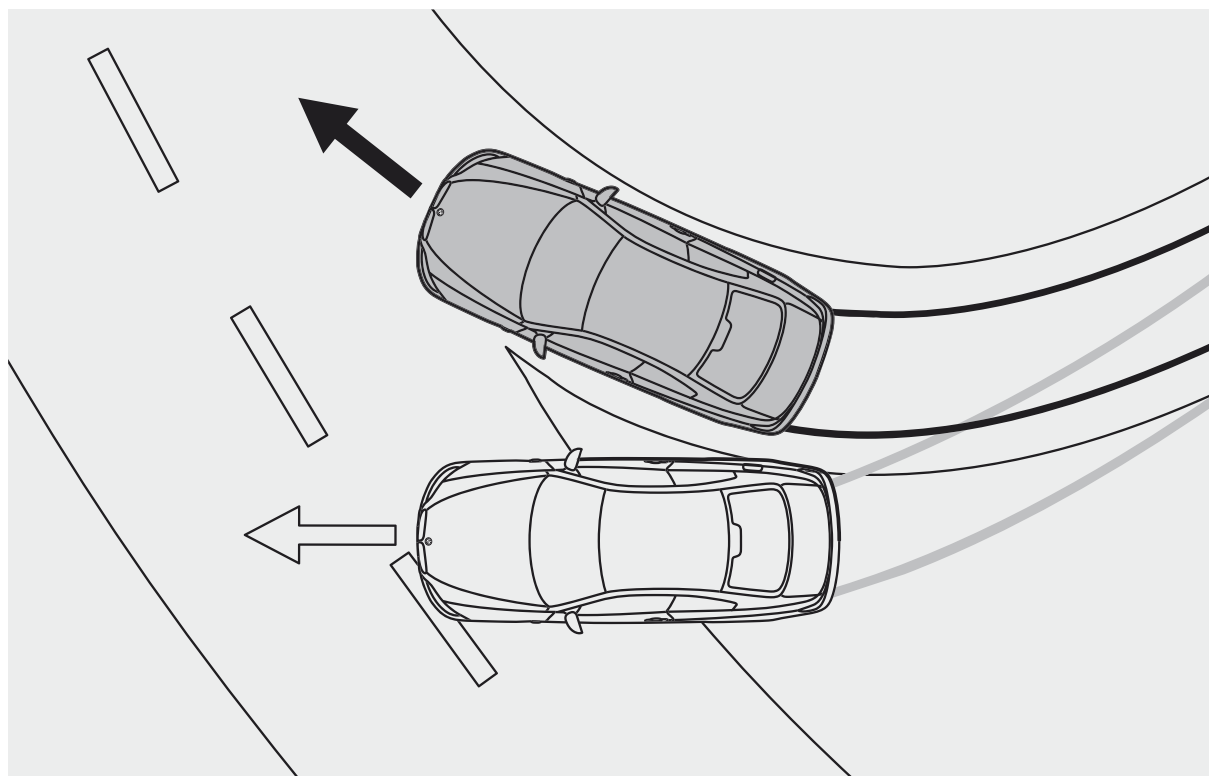

Dynamic Stability Control (DSC) with Dynamic Traction Control (DTC) features Brake Drying, Brake Stand-by, Brake Fade Compensation and Start-off Assistant. DSC is a braking control system that, when it senses an impending skid, helps to stabilize the 3 Series Coupe in just milliseconds. If the system senses over- or understeer, it modulates engine power and can apply brakes individually to help keep the vehicle under control and going in the intended direction. For sportier driving or in deep snow, the DTC system allows increased wheelslip.



BMW restraint system for the driver and front passenger consists of a three-point safety belt and safety-belt pretensioner, working in tandem for optimal protection in the event of an impact.

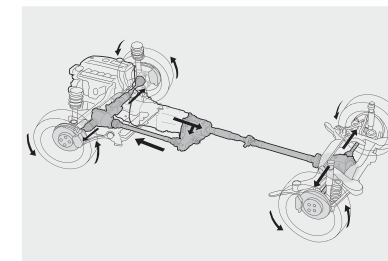

xDrive all-wheel-drive system monitors readings from the DSC sensors and the gas pedal to determine if over- or understeer is occurring. This data is then used to continually vary power distribution between the front and rear axles, ensuring agile, neutral and forgiving handling at all times. (Standard in xDrive models; not available in 328i or 335i.)

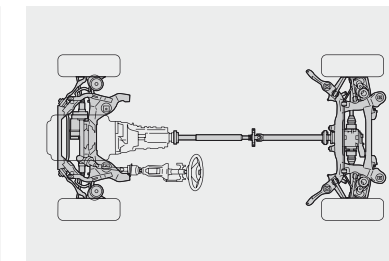

Innovative chassis is constructed using the latest technology in steel production. Using a stronger steel for the chassis results in a smoother ride, remarkable handling and enhanced active and passive safety.

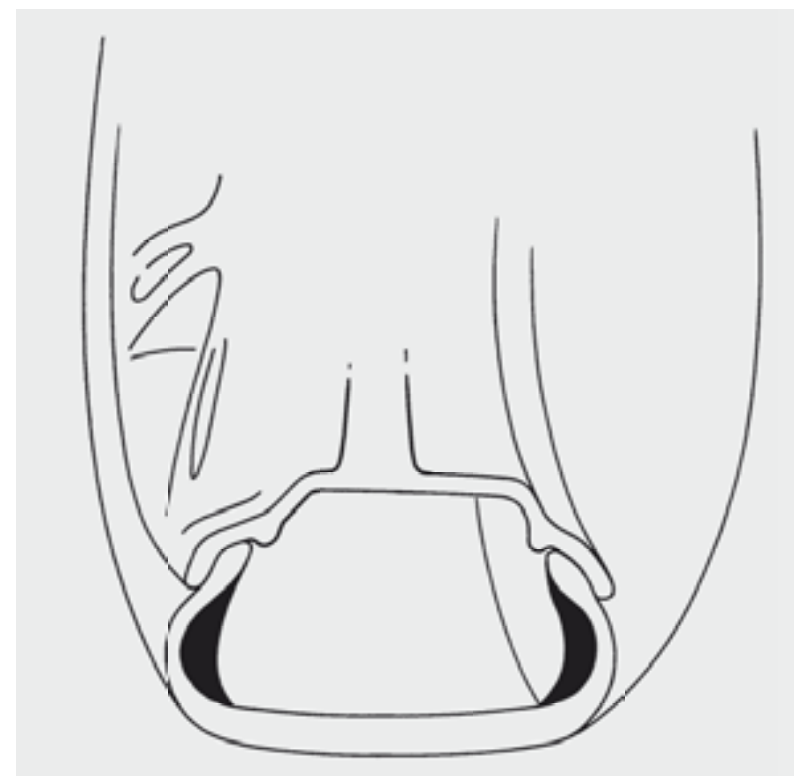

Run-flat tires allow speeds of up to 50 mph and travel from 30 to 150 miles after a loss of air pressure, dependent upon the passenger load and weight of articles being transported. In situations that would normally result in a flat, reinforced sidewalls help prevent the tires from collapsing or loosening from the rim. Please see your vehicle manual for additional details.

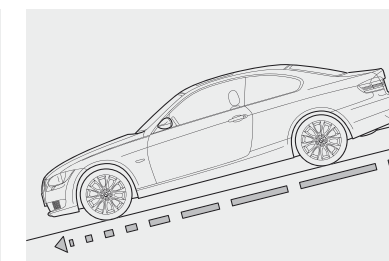

Hill Descent Control (HDC) is a feature of the xDrive all-wheel-drive system that helps you drive down steep hills without having to ride the brake pedal. Simply press the HDC button and the vehicle's speed is kept under control automatically. (Standard in xDrive models; not available in 328i or 335i.)

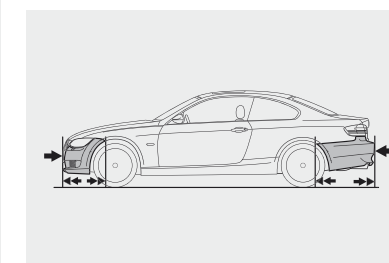

Impact-absorbing bumpers and compressible crush tubes front and rear help absorb the force of impact in collisions up to nine mph, helping to minimize damage to the vehicle's body and simplifying repairs. Only at higher impact speeds do structural supports begin to deform, dissipating impact energy to help protect occupants.

Performance and efficiency	328i	328i xDrive	335i	335i xDrive
3.0-liter dual overhead cam (DOHC), 24-valve inline 230-horsepower 6-cylinder engine with composite magnesium/aluminum engine block, Valvetronic, and Double-VANOS steplessly variable valve timing	●	●		
3.0-liter dual overhead cam (DOHC), 24-valve inline turbocharged 300-horsepower 6-cylinder engine with Advanced Turbo technology and Double-VANOS steplessly variable valve timing			●	●
Electronic throttle control	●	●	●	●
6-speed manual transmission	●	●	●	●
6-speed STEPTRONIC automatic transmission with Adaptive Transmission Control	○	○	○	○
Steering wheel-mounted paddle shifters (automatically included when STEPTRONIC automatic transmission and Sport Package or M Sport Package are ordered)	○	○	○	○

Handling, ride and braking	328i	328i xDrive	335i	335i xDrive
Dynamic Stability Control (DSC), including Brake Fade Compensation, Start-off Assistant, Brake Drying, and Brake Stand-by features, with Dynamic Traction Control (DTC)	●	●	●	●
Extensive aluminum componentry, including front suspension components (forged-aluminum lower arms, steering knuckle); subframe; steering rack; and brake components	●	●	●	●
Double-pivot type front and five-link rear suspension	●	●	●	●
xDrive all-wheel-drive system		●		●
Front and rear anti-roll (stabilizer) bars	●	●	●	●
Twin-tube gas-pressure shock absorbers	●	●	●	●
Sport suspension calibration	●		●	
4-wheel ventilated anti-lock disc brakes with Dynamic Brake Control (DBC)	●	●	●	●
Engine-speed-sensitive, variable-assist power steering	●	●	●	●
Active Steering with Servotronic power assist			○	
Increased top-speed limiter	□/■	□/■	□/■	□/■
Hill Descent Control		●		●

- Standard
- Optional
- Included in Sport Package
- Included in M Sport Package
- ◇ Included in Premium Package
- ★ Included in Cold Weather Package

Exterior	328i	328i xDrive	335i	335i xDrive
Star Spoke (Style 157) 17 x 8.0 light alloy wheels, 225/45 run-flat ¹ all-season tires	●	●		
Star Spoke (Style 185) 17 x 8.0 light alloy wheels, 225/45 run-flat ¹ all-season tires		□	●	●
Cross Spoke (Style 197) light alloy wheels, 18 x 8.0 front, 18 x 8.5 rear; 225/40 front, 255/35 rear run-flat ¹ performance tires ² (328i xDrive requires Sport Package)	□	○		
Star Spoke (Style 189) light alloy wheels, 18 x 8.0 front, 18 x 8.5 rear; 225/40 front, 255/35 rear run-flat ¹ performance tires ² (335i xDrive requires Sport Package)			□	○
V Spoke (Style 188) 17 x 8.0 light alloy wheels, 225/45 run-flat ¹ all-season tires				□
Star Spoke (Style 230) light alloy wheels, 19 x 8.0 front, 19 x 9.0 rear; 225/35 front, 255/30 rear run-flat ¹ performance tires ² (335i requires Sport Package)			○	
Star Spoke (Style 193M) M light alloy wheels, 18 x 8.0 front, 18 x 8.5 rear; 225/40 front, 255/35 rear run-flat ¹ performance tires ²	■	■	■	■
Double Spoke (Style 225M) M light alloy wheels, 19 x 8.0 front, 19 x 9.0 rear; 225/35 front, 255/30 rear run-flat ¹ performance tires ² (requires M Sport Package)			○	
Tire Pressure Monitor	●	●	●	●
Xenon Adaptive Headlights with auto-leveling	●	●	●	●
Halogen free-form front foglights	●	●	●	●
Retractable, high-intensity headlight washers	★	●	★	●
Heated dual power mirrors and heated windshield washer jets	●	●	●	●
Chrome-plated exhaust tips	●	●	●	●
Shadowline trim	□/■	□/■	□/■	□/■
Aerodynamic kit	■	■	■	■
Metallic paint	○	○	○	○

Interior seating and trim	328i	328i xDrive	335i	335i xDrive
8-way adjustable driver's seat and 6-way adjustable front passenger's seat (includes 2-way headrests)	●	●		
8-way power front seats with 2-way manual headrests and driver memory with 2 pre-sets for seat and exterior mirror positions	○/◇	○/◇	●	●
8-way manual front sport seats with adjustable side bolsters, 2-way manual headrests and thigh support	□	□		
8-way power front sport seats with adjustable side bolsters, 2-way manual headrests with Active Head Restraints feature, and thigh support; driver memory for exterior mirror and seat positions (requires optional power seats or Premium Package in 328i and 328i xDrive)	□	□	□	□
4-way adjustable power lumbar support for front seats	◇	◇	◇	◇
Leatherette upholstery	●	●	●	●
Dakota Leather upholstery	○/◇	○/◇	○/◇	○/◇
Dark Burl Walnut Wood trim	●	●	●	●
Light Burl Walnut Wood trim (no-cost option)	○	○	○	○
Gray Poplar Wood trim (no-cost option)	○	○	○	○
Aluminum trim (no-cost option)	○	○	○	○
Glacier Silver Aluminum trim (no-cost option; requires M Sport Package)	○	○	○	○
Anthracite headliner	■	■	■	■
3-stage heated front seats	○/★	○/★	○/★	○/★
Front seatback storage nets	●	●	●	●
Split fold-down rear seats	●	●	●	●
Ski bag	★	★	★	★

¹Run-flat tires do not come equipped with spare tire.
²Performance tires are not recommended for driving in snow and ice. Due to low-profile tires, please note: wheels, tires and suspension parts are more susceptible to road hazard and consequential damages.

Comfort and convenience	328i	328i xDrive	335i	335i xDrive
Engine Start/Stop button	●	●	●	●
Comfort Access keyless entry with multi-function remote control	○	○	○	○
Automatic climate control includes micro-filter, automatic air recirculation, left/right temperature control, temperature- and volume-controlled rear outlets, windshield misting sensor, maximum air conditioning, heat at rest, and recall of individual user settings	●	●	●	●
2-way power glass moonroof with one-touch operation, sliding interior sunshade, and wind deflector	○/◇	○/◇	○/◇	○/◇
Door storage pockets with covers	●	●	●	●
Front-seat center armrest with storage compartment	●	●	●	●
Front cupholders	●	●	●	●
Rear seat with fold-down center armrest with dual cupholders, and storage bin with retractable cover	●	●	●	●
Tilt/telescopic steering wheel column	●	●	●	●
Park Distance Control (PDC) (rear only)	○/■	○/■	○/■	○/■
Interior and power-adjustable folding exterior mirrors with automatic-dimming function; digital interior mirror compass	◇	◇	◇	◇
Power front windows with one-touch up/down operation	●	●	●	●
Power rear sunshade	○	○	○	○
Dynamic Cruise Control	●	●	●	●
Active Cruise Control	○	○	○	○
Automatic high beams	○	○	○	○
BMW Ambiance lighting	●	●	●	●
Courtesy lights include fade in/fade out, actuation from remote, automatic switch-on when engine is turned off, separately controlled left/right front and rear reading lights, front footwell lighting, and illuminated vanity mirrors	●	●	●	●
Ground lighting located in bottom of exterior door handles	●	●	●	●
Automatic safety belt assistant	●	●	●	●
Locking glovebox	●	●	●	●
Electric interior trunk release	●	●	●	●
Rain-sensing windshield wipers and Automatic headlight control	●	●	●	●
Integrated 3-button Universal garage-door opener	◇	◇	◇	◇
Heated steering wheel	★	★	★	★

Audio system	328i	328i xDrive	335i	335i xDrive
Anti-theft AM/FM stereo CD/MP3 player audio system with Radio Data System (RDS)	●	●	●	●
Logic7 Surround Sound anti-theft AM/FM stereo CD/MP3 player audio system with 13 upgraded speakers (including 2 subwoofers), Digital Sound Processing (DSP), Radio Data System (RDS), Auto-Store and 3-channel FM diversity antenna; displays MP3 song title and artist	○	○	○	○
Auxiliary audio input for portable music players located in the center armrest	●	●	●	●
SIRIUS Satellite Radio with one-year subscription	○/△	○/△	○/△	○/△
iPod® and USB adaptor (includes cable connector)	○/△	○/△	○/△	○/△
Smartphone integration (requires iPod and USB adaptor and Premium Package or BMW Assist™)	○	○	○	○
HD Radio™ with multicast FM station reception	●	●	●	●

- Standard
- Optional
- Included in M Sport Package
- ◇ Included in Premium Package
- ★ Included in Cold Weather Package
- △ BMW center-installed accessory

Instrumentation and controls	328i	328i xDrive	335i	335i xDrive
Service Interval Indicator with miles-to-service readout	●	●	●	●
3-spoke leather-wrapped multi-function sport steering wheel with audio and hands-free phone controls	●	●	●	●
3-spoke leather-wrapped multi-function M Sport steering wheel with audio and hands-free phone controls	■	■	■	■
On-board computer with Check Control provides feedback on the vehicle's operating status: oil level indicator and distance to next service appointment/oil change, as well as other detailed information, such as spark plug and micro-filter status. It also provides travel information travel range on remaining fuel, external temperature, and more	●	●	●	●
BMW Navigation system with 16:9 high-resolution, 3-D screen, Voice Command system, and Real Time Traffic Information; iDrive system with high-function on-board computer, Controller, and 6 programmable memory buttons; and 12 GB storage for audio files (also includes Online Information Services when equipped with BMW Assist)	○	○	○	○

Safety and security	328i	328i xDrive	335i	335i xDrive
Anti-lock braking system (ABS)	●	●	●	●
Adaptive Brake Lights	●	●	●	●
BMW's Advanced Safety System for integrated deployment of passive and active safety features	●	●	●	●
Front and rear Head Protection System (HPS)	●	●	●	●
Automatic safety-belt pretensioners at front seating positions	●	●	●	●
Driver's and passenger's front airbag supplemental restraint system (SRS) with advanced technology: dual-threshold, dual-stage deployment; and front-passenger seat sensors designed to prevent unnecessary airbag deployment	●	●	●	●
Seat-mounted front side-impact airbags	●	●	●	●
Front passenger seat-occupation recognition with Passenger's Airbag Off indicator	●	●	●	●
Interlocking door anchoring system to help protect against door intrusion in side impacts	●	●	●	●
Central locking system with center console switch (leaves gas filler door unlocked), double-lock feature and 2-step unlocking	●	●	●	●
Coded Driveaway Protection	●	●	●	●
Automatic-locking retractors (ALR) on all passenger-seat safety belts for installation of child-restraint seat	●	●	●	●
LATCH attachments on child-restraint safety installation	●	●	●	●
Crash sensor that automatically turns on hazard lights and interior lights, and unlocks doors	●	●	●	●
Programmable Daytime Running Lights	●	●	●	●
BMW Assist with Bluetooth® wireless technology for hands-free calling (with Bluetooth enabled mobile phone), with phonebook downloading and speech recognition capabilities (please visit your authorized BMW center for details on standard and optional services and a list of BMW-approved Bluetooth technology enabled mobile phones; also includes Online Information Services when equipped with BMW Navigation system)	○/◇	○/◇	○/◇	○/◇

BMW Services	328i	328i xDrive	335i	335i xDrive
BMW Ultimate Service™ (for complete details on BMW Ultimate Service, visit bmwusa.com/ultimateservice)	●	●	●	●

Premium Package	328i	328i xDrive	335i	335i xDrive
8-way power front seats with 2-way manual headrests and driver memory with 2 pre-sets for seat and exterior mirror positions	○/◇	○/◇	●	●
4-way adjustable power lumbar support for front seats	◇	◇	◇	◇
Dakota Leather upholstery	○/◇	○/◇	○/◇	○/◇
Interior and power-adjustable folding exterior mirrors with automatic-dimming function; digital interior mirror compass	◇	◇	◇	◇
Integrated 3-button Universal garage-door opener	◇	◇	◇	◇
BMW Assist™ with Bluetooth® wireless technology for hands-free calling (with Bluetooth enabled mobile phone), with phonebook downloading and speech recognition capabilities (please visit your authorized BMW center for details on standard and optional services and a list of BMW-approved Bluetooth technology enabled mobile phones; also includes Online Information Services when equipped with BMW Navigation system)	○/◇	○/◇	○/◇	○/◇

Sport Package (not available with M Sport Package)	328i	328i xDrive	335i	335i xDrive
Steering wheel-mounted paddle shifters (automatically included when STEPTRONIC automatic transmission and Sport Package are ordered)	○	○	○	○
Star Spoke (Style 185) 17 x 8.0 light alloy wheels, 225/45 run-flat ³ all-season tires		□		
Cross Spoke (Style 197) light alloy wheels, 18 x 8.0 front, 18 x 8.5 rear; 225/40 front, 255/35 rear run-flat ³ performance tires ⁴ (328i xDrive requires Sport Package)	□	○		
Star Spoke (Style 189) light alloy wheels, 18 x 8.0 front, 18 x 8.5 rear; 225/40 front, 255/35 rear run-flat ³ performance tires ⁴ (335i xDrive requires Sport Package)			□	○
V Spoke (Style 188) 17 x 8.0 light alloy wheels, 225/45 run-flat ³ all-season tires				□
Star Spoke (Style 230) light alloy wheels, 19 x 8.0 front, 19 x 9.0 rear; 225/35 front, 255/30 rear run-flat ³ performance tires ⁴ (335i requires Sport Package)			○	
8-way manual front sport seats with adjustable side bolsters, 2-way manual headrests and thigh support	□	□		
8-way power front sport seats with adjustable side bolsters, 2-way manual headrests with Active Head Restraints feature, and thigh support; driver memory for exterior mirror and seat positions (requires optional power seats or Premium Package in 328i and 328i xDrive)	□	□	□	□
Shadowline trim	□	□	□	□

M Sport Package (not available with Sport Package)	328i	328i xDrive	335i	335i xDrive
Star Spoke (Style 193M) M light alloy wheels, 18 x 8.0 front, 18 x 8.5 rear; 225/40 front, 255/35 rear run-flat ³ performance tires ⁴	■	■	■	■
Double Spoke (Style 225M) M light alloy wheels, 19 x 8.0 front, 19 x 9.0 rear; 225/35 front, 255/30 rear run-flat ³ performance tires ⁴ (requires M Sport Package)			○	
8-way power front sport seats with adjustable side bolsters, 2-way manual headrests with Active Head Restraints feature, and thigh support; driver memory for exterior mirror and seat positions (requires optional power seats or Premium Package in 328i and 328i xDrive)	■	■	■	■
3-spoke leather-wrapped multi-function M Sport steering wheel with audio and Bluetooth phone controls (if so equipped)	■	■	■	■
Park Distance Control (PDC) (rear only)	○/■	○/■	○/■	○/■
Sport suspension calibration	■	■	■	■
Increased top-speed limiter	■	■	■	■
Shadowline trim	■	■	■	■
Anthraccite headliner	■	■	■	■
Aerodynamic kit	■	■	■	■
Steering wheel-mounted paddle shifters (automatically included when STEPTRONIC automatic transmission and M Sport Package are ordered)	○	○	○	○
<ul style="list-style-type: none"> ● Standard ○ Optional □ Included in Sport Package ■ Included in M Sport Package ◇ Included in Premium Package ★ Included in Cold Weather Package △ BMW center-installed accessory 				

³Run-flat tires do not come equipped with spare tire.

⁴Performance tires are not recommended for driving in snow and ice.

Due to low-profile tires, please note: wheels, tires and suspension parts are more susceptible to road hazard and consequential damages.

Cold Weather Package	328i	328i xDrive	335i	335i xDrive
Retractable, high-intensity headlight washers	★	●	★	●
3-stage heated front seats	○/★	○/★	○/★	○/★
Heated steering wheel	★	★	★	★
Ski bag	★	★	★	★

Stand-alone optional equipment	328i	328i xDrive	335i	335i xDrive
Dakota Leather upholstery	○	○	○	○
Metallic paint	○	○	○	○
Cross Spoke (Style 197) light alloy wheels, 18 x 8.0 front, 18 x 8.5 rear; 225/40 front, 255/35 rear run-flat ³ performance tires ⁴ (328i xDrive requires Sport Package)		○		
Star Spoke (Style 189) light alloy wheels, 18 x 8.0 front, 18 x 8.5 rear; 225/40 front, 255/35 rear run-flat ³ performance tires ⁴ (335i xDrive requires Sport Package)				○
Star Spoke (Style 230) light alloy wheels, 19 x 8.0 front, 19 x 9.0 rear; 225/35 front, 255/30 rear run-flat ³ performance tires ⁴ (335i requires Sport Package)			○	
Light Burl Walnut Wood interior trim (no-cost option)	○	○	○	○
Gray Poplar Wood interior trim (no-cost option)	○	○	○	○
Aluminum interior trim (no-cost option)	○	○	○	○
6-speed STEPTRONIC automatic transmission	○	○	○	○
Steering wheel-mounted paddle shifters (automatically included when STEPTRONIC automatic transmission and Sport Package or M Sport Package are ordered)	○	○	○	○
Active Steering with Servotronic power assist			○	
Comfort Access keyless entry	○	○	○	○
Power rear sunshade	○	○	○	○
8-way power front seats	○	○	●	●
3-stage heated front seats	○	○	○	○
Park Distance Control (PDC) (rear only)	○/■	○/■	○/■	○/■
Active Cruise Control	○	○	○	○
Navigation system with 16:9 screen and Voice Command system; iDrive system with high-function on-board computer and Controller; includes Real Time Traffic Information feature	○	○	○	○
BMW Assist with Bluetooth wireless technology for hands-free calling (with Bluetooth enabled mobile phone), with phonebook downloading and speech recognition capabilities (please visit your authorized BMW center for details on standard and optional services and a list of BMW-approved Bluetooth technology enabled mobile phones; also includes Online Information Services when equipped with BMW Navigation system)	○/◇	○/◇	○/◇	○/◇
SIRIUS Satellite Radio with one-year subscription	○/△	○/△	○/△	○/△
Logic7 Surround Sound audio system	○	○	○	○
Automatic high beams	○	○	○	○
iPod® and USB adaptor (includes cable connector)	○/△	○/△	○/△	○/△
Anti-theft alarm system	○	○	○	○

Weight		328i	328i xDrive	335i	335i xDrive
Unladen	lbs	3351 (3417)	3582 (3627)	3571 (3582)	3759 (3770)
Weight distribution, front/rear					
Manual transmission	%	50.3/49.7	52.9/47.1	51.2/48.8	52.8/47.2
Automatic transmission	%	50.6/49.4	52.9/47.1	51.4/48.6	52.9/47.1

Engine		328i	328i xDrive	335i	335i xDrive
Liter/type/valves per cylinder		3.0/inline 6/4	3.0/inline 6/4	Turbocharged 3.0/inline 6/4	Turbocharged 3.0/inline 6/4
Bore/stroke	inch	3.35/3.46	3.35/3.46	3.31/3.53	3.31/3.53
Nominal output/rpm	hp	230/6500	230/6500	300/5800	300/5800
Maximum torque/rpm	lb-ft	200/2750	200/2750	300/1400-5000	300/1400-5000
Compression ratio	:1	10.7	10.7	10.2	10.2
Fuel grade		unleaded premium	unleaded premium	unleaded premium	unleaded premium

Transmission		328i	328i xDrive	335i	335i xDrive
Manual gear ratios					
I/II	:1	4.32/2.46	4.35/2.50	4.06/2.40	4.06/2.40
III/IV	:1	1.66/1.23	1.66/1.23	1.58/1.19	1.58/1.19
V/VII/R	:1	1.00/0.85/3.94	1.00/0.85/3.93	1.00/0.87/3.68	1.00/0.87/3.68
Final drive ratio	:1	3.23	3.38	3.08	3.08
Automatic gear ratios					
I/II	:1	4.07/2.37	4.07/2.37	4.17/2.34	4.17/2.34
III/IV	:1	1.55/1.20	1.55/1.20	1.52/1.14	1.52/1.14
V/VII/R	:1	0.85/0.67/3.20	0.85/0.67/3.20	0.87/0.69/3.40	0.87/0.69/3.40
Final drive ratio	:1	3.73	3.91	3.46	3.46

Performance		328i	328i xDrive	335i	335i xDrive
Drag coefficient	C _d	0.28	0.30	0.30	0.30
Top speed ¹	mph	130 [150]	130 [150]	130 [150]	130 [150]
Acceleration 0-60 mph ²					
Manual transmission	sec	6.2	6.8	5.3	5.2
Automatic transmission	sec	(6.8)	(7.0)	(5.5)	(5.3)

Figures in () apply to vehicles with automatic transmission.
 Figures in [] apply to vehicles with Sport Package and M Sport Package.

¹ Top speed limited electronically.
² BMW AG test results. Actual acceleration results may vary, depending on specification of vehicle; road and environmental conditions; testing procedures and driving style. These results should be used for comparison only and verification should not be attempted on public roads. BMW urges you to obey all posted speed laws and always wear safety belts.
³ EPA-estimated figures are for comparison purposes only. Your actual mileage will vary, depending on speed, driving habits, trip length and driving conditions; actual mileage may be lower.

Fuel consumption ³		328i	328i xDrive	335i	335i xDrive
Manual transmission	City/Highway mpg	18/28	17/25	17/26	16/25
Automatic transmission	City/Highway mpg	19/28	17/25	17/26	17/25

Tires and wheels		328i	328i xDrive	335i	335i xDrive
Tire dimensions	standard	225/45	225/45	225/45	225/45
Wheel dimensions	standard	17 x 8.0	17 x 8.0	17 x 8.0	17 x 8.0
Material	standard	light alloy	light alloy	light alloy	light alloy

Brakes		328i	328i xDrive	335i	335i xDrive
Front diameter	inch	12.3	12.3	13.7	13.7
Rear diameter	inch	11.8	11.8	13.2	13.2

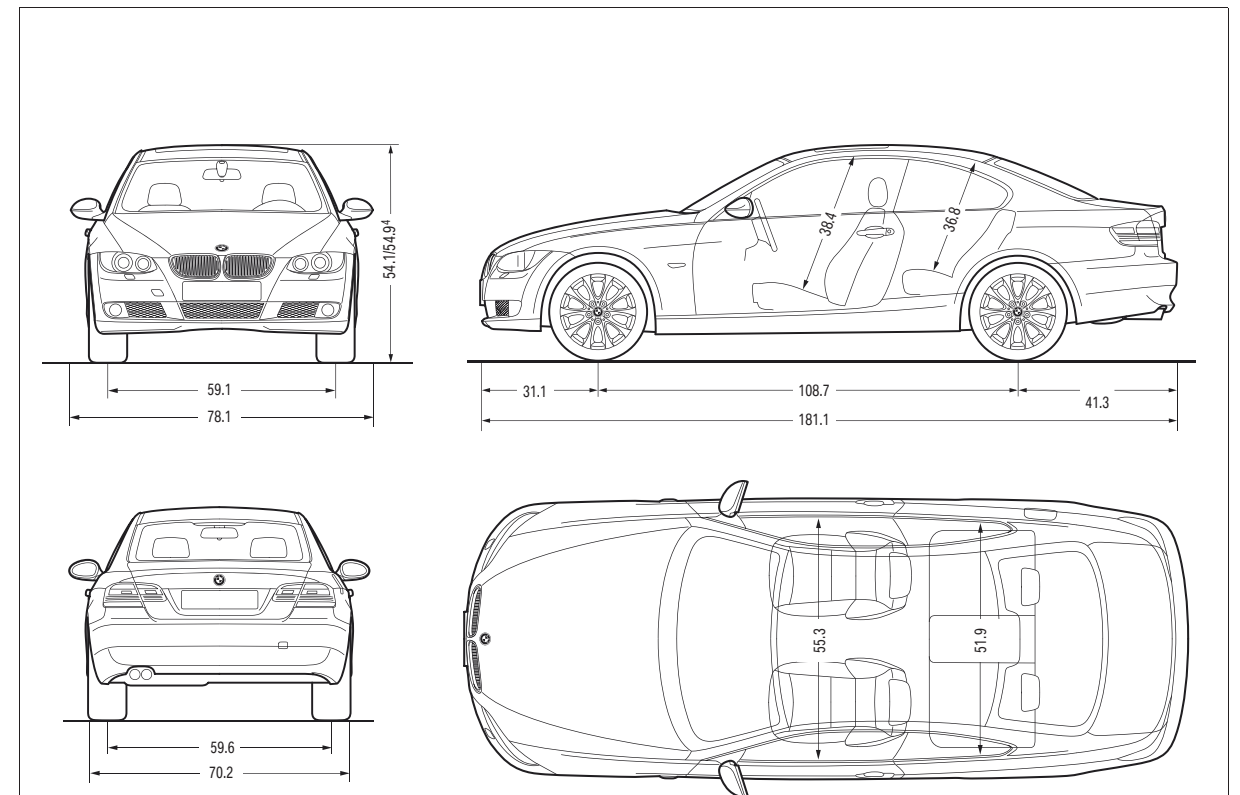

Illustrations above: all dimensions in inches.

⁴ 54.1 inches 328i, 335i; 54.9 inches 328i xDrive, 335i xDrive.

BMW European Delivery: Save money and drive your new BMW on the roads it was designed for.

The new **BMW Welt** (BMW World) delivery and brand-experience center in Munich is bold proof of BMW's passion for design. When you take advantage of the BMW European Delivery Program,¹ this is where you will meet your new BMW in a personalized process that is highly dramatic and totally unforgettable. (You might also realize substantial savings that just may pay for your trip.) While you're there, marvel at the historic BMWs in the Museum; learn about our engineers' newest innovations in the Technology and Design Atelier; and take a tour of the plant to experience firsthand the state-of-the-art methods used to create a BMW. Then comes the unique experience of driving your new BMW on the roads it was designed for. To learn more, visit bmwusa.com/europeandelivery.



BMW Ultimate Service™

At BMW, we believe that a premium ownership experience should feature performance and luxury, as well as safety and convenience. We believe you should be able to drive a BMW to its potential, while enjoying peace of mind and reduced cost of ownership. That's the idea behind BMW Ultimate Service: a suite of comprehensive programs and services that are included in every 2009 and later model year vehicle. The New Vehicle Limited Warranty, the BMW Maintenance Program, and Roadside Assistance come standard, with BMW Assist™ offered as an option. BMW Ultimate Service starts with the **New Vehicle Limited Warranty**, providing you with coverage for the first four years or 50,000 miles, whichever comes first. Additionally, you have 12-year, unlimited-mileage warranty protection against corrosion and rust perforation.² **BMW Maintenance Program** is one of the most comprehensive maintenance programs in its class. We cover all factory-recommended maintenance during the New Vehicle Limited Warranty coverage period. This includes scheduled oil services and inspections. Also covered is the replacement of items that are subject to normal wear and tear, such as brake pads, wiper blade inserts and engine drive belts.³ And, thanks to BMW's advanced engineering, most owners enjoy a well-balanced maintenance schedule, with flexible routine service intervals that can save you time. When your vehicle requires attention, your authorized BMW center ensures that it receives only genuine BMW parts—your assurance of exacting quality standards.

BMW Roadside Assistance is provided free of charge for the first four years—with no mileage limit. Call **1-800-332-4BMW (4269)** for friendly on-the-road help, 24/7, anywhere in the United States, Canada and Puerto Rico. This includes everything from flat-tire changes, emergency gasoline and lock-out service, to towing, alternative transportation and even trip-interruption benefits. This service also provides valuable trip-routing advice.

The **BMW Assist™** Safety Plan⁴ is an optional four-year program. You'll enjoy peace of mind knowing that a friendly response specialist is there to help you, 24/7, at just the push of a button. The Safety Plan includes Automatic Collision Notification, Emergency Request, Enhanced Roadside Assistance, Door Unlock, Stolen Vehicle Recovery and Customer Relations. MyInfo allows you to send business locations and street addresses with their associated phone numbers from the Google Maps™ website directly to your BMW. The destination can be sent to your Navigation system for turn-by-turn directions, and you can call the destination via your Bluetooth® linked cell phone. And for the ultimate in coverage, add the optional **Convenience Plan**.⁵ You'll enjoy unlimited access to personalized Directions, Traffic and Weather reports, as well as our Concierge feature, which can send a destination address and phone number, such as a restaurant or hotel, right to your BMW. You can make up to four operator-assisted calls per year with Critical Calling if your cell phone is not available, or if its battery is discharged. BMW Search allows online access to up-to-date fuel prices and the latest weather forecasts, as well as Bloomberg's stock indices and the powerful reach of the Google Maps™ database—delivered to the iDrive display right inside your vehicle.

BMW's unique **TeleService**, included in the BMW Assist Safety Plan, continually monitors specific parts that are subject to wear and tear—including the engine oil, micro-filter, spark plugs, brake linings and various fluids—as well as services that require attention at regular intervals, such as vehicle service inspections. This data is automatically transmitted to your BMW center, which will then call you to schedule a service appointment. You don't have to keep track of when your car requires routine maintenance. An added benefit: any needed maintenance service parts will already be on hand, so your BMW is serviced and returned to you as quickly as possible.

For more details on BMW Ultimate Service, visit your preferred BMW center or log on to bmwusa.com/ultimateservice.

BMW Virtual Center.

If you get the sudden urge to shop for a BMW but your BMW center is closed, there's good news—the BMW Virtual Center is open 24 hours a day! Log on to bmwusa.com, then click on the model series you are interested in. After selecting the BMW that interests you, click on **Build Your Own**. Configure the BMW of your dreams, and see what the monthly payments would be. You can even send the specifications to your authorized BMW center, apply for financing or request a test drive—all online!

BMW Financial Services.

Arranging to buy or lease a BMW is easier than you may think. Your authorized BMW center offers leasing and financing to suit your personal needs through BMW Financial Services.⁶ Start the process at our website, where you can build your dream vehicle, get an estimate on a monthly lease or financing payment, submit a credit application to BMW Financial Services and get approval—all online!⁶ To find out how BMW Financial Services can help put you behind the wheel of your favorite BMW model, log on to bmwusa.com/fs or call, toll-free, **1-800-578-5000**.

BMW Publications and Media Gallery.

Sent to new owners and lessees several times a year, **BMW Magazine** is a fascinating view of the latest events and products in the world of BMW, including personality profiles, travel reviews, and the latest BMW technologies. You can read articles from **BMW Magazine**, as well as **Mdriver** and **Inside Track**, on the BMW website at bmwusa.com in the Media Gallery/News Feed, found in the Experience section. Here you can also view featured videos and images, read recent news articles, and download BMW wallpapers. For more information, call Customer Assistance at **1-800-334-4BMW (4269)** or visit BMW online at bmwusa.com.

¹ Not all models available for BMW European Delivery Program. Please go to bmwusa.com or visit your authorized BMW center for details.

² See your authorized BMW center for details on these limited warranties.

³ The BMW Maintenance Program covers factory-recommended maintenance services as determined by the Service Interval Indicator for all new eligible MY 2004 and later BMW vehicles. Specific additional items that need replacement due to normal wear and tear are also covered. The maintenance coverage period is for the first 4 years or 50,000 miles, whichever comes first. Exclusions from coverage include: gasoline, gasoline additives, windshield washer fluid and additives, tires, wheels, wheel alignment and tire balancing. All work must be performed by an authorized BMW center. See the Service and Warranty Information booklet for specific terms, conditions and limitations. Further information can also be obtained from your authorized BMW center.

⁴ The BMW Assist and Bluetooth Hands-free Calling system with 4 years of Safety Plan services is optional or included in the Premium Package. In order to receive BMW Assist services, a subscriber agreement must be completed and transferred to the BMW Assist Response Center. GPS and underlying wireless services must be available and functioning; vehicle ignition must be turned on (except for Door Unlock and Stolen Vehicle recovery), battery charged and connected and vehicle's electrical system operational; services may be limited to certain geographic areas. Call toll-free **1-888-333-6118**, log on to bmwassist.com, or visit your BMW center for additional program details. Services are subject to the terms and conditions of your subscriber agreement.

⁵ Requires BMW Assist Safety Plan subscription. Services are subject to the terms and conditions of your subscriber agreement. Please go to bmwassist.com for additional details on the optional Convenience Plan.

⁶ Subject to credit approval and other terms and conditions.

More about BMW

bmwusa.com
1-800-334-4BMW



The Ultimate
Driving Machine®

BMW and the environment.

BMW is a strong proponent of the environment and social responsibility. It is important to manage the earth's resources responsibly, and not jeopardize the needs of future generations. That is why BMW makes vehicles that minimize adverse environmental impact, from production (pollution prevention and waste minimization at the plant) through owner use (low emissions) to eventual disposal (easy drainability of all fluid-related components and easy neutralization of all pyrotechnic devices).

This effort has been recognized worldwide and, as a result, we are pleased to have received numerous environmental honors. In the U.S., for example, the Environmental Protection Agency accepted BMW's Spartanburg, SC production and manufacturing facility as a charter member of the agency's National Environmental Performance Track. Internationally, BMW AG—the parent company of both BMW of North America and BMW Manufacturing Co., Spartanburg, SC—was the first automotive company to be represented on the Dow Jones Sustainability Group Index, and has remained on the Index ever since. At BMW, we strive for high performance in everything we do.

U.S. Importer: BMW of North America, LLC, Woodcliff Lake, NJ 07677. All illustrations and specifications contained in this brochure are based on the latest product information available at the time of printing. BMW reserves the right to make changes at any time, without notice, in colors, materials, equipment, specifications and models. BMW may, subject to legal requirements, determine the Model Year designation of its vehicles. The Model Year designation on any particular model may be longer or shorter than 12 months. Some vehicles pictured may contain non-U.S. equipment. Some models may be shown with optional equipment. While BMW NA makes all reasonable efforts to provide accurate information in this brochure, there is no guarantee or warranty of accuracy. Furthermore, we do not assume any liability for the accuracy or completeness of information presented. This brochure shall not be used or relied upon as a substitute for information that is available from your BMW center. Further information can be obtained from your authorized BMW center or bmwusa.com.

©2009 BMW of North America, LLC. Not to be reproduced wholly or in part without written permission of BMW NA. The BMW name, model names and logo are registered trademarks.

The Bluetooth word mark and logos are owned by the Bluetooth SIG, Inc. and any use of such marks by BMW is under license. iPod is a registered trademark of Apple Inc. Other trademarks and trade names are those of their respective owners.

BMW recommends 