

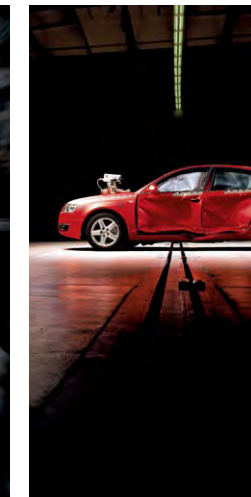

# A4 S4

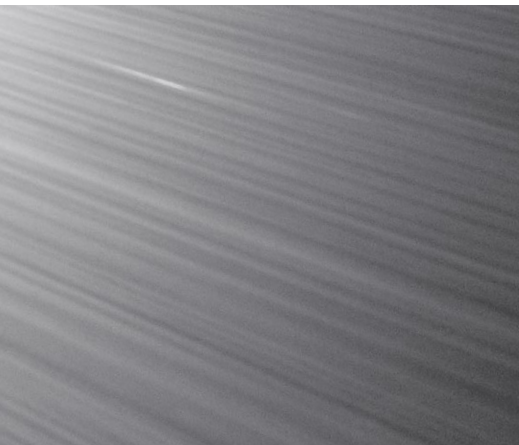

substance always wins the day

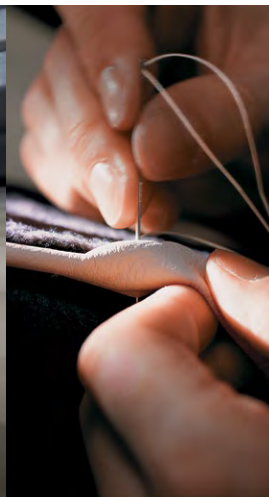

It takes more than hard work, dedication and vision to create the truly exceptional. It takes something intangible. Something you can't quite put your hands on. It's courage, guts, perseverance, passion and fierceness of focus all wrapped into one.

And it's this intangible characteristic that defines all of us at Audi. It's the driving force behind

every pencil line we draw, every calculation we make and every idea we deem not good enough.

It's why every inch and curve and angle has purpose. It's why we test our cars at the highest of speeds for hours on end so they can be driven on any surface and in any condition - rain, shine or white-out blizzard.

It's why substance always wins the day. It's why cutting a corner, even a weld seam in the trunk, would be sacrilegious. And it's why for us scrutiny is so deeply ingrained it's like the very act of breathing.

This is Truth in Engineering. And this is Audi.

a badge doesn't define you  
it represents you

---





## Contents

---

- ▶ 6-15 The A4 Experience

---

  - ▶ 16-21 The S4 Experience

---

  - ▶ 22 Efficiency
  - ▶ 24 quattro®
  - ▶ 26 Audi drive select
  - ▶ 28 MMI®
  - ▶ 30 Safety

---

  - ▶ 32 A4 Premium | Premium Plus
  - ▶ 36 A4 Prestige | Packages
  - ▶ 40 A4 Options | S4 Premium Plus
  - ▶ 44 S4 Prestige | Options
  - ▶ 48 S4 Packages | Accessories
  - ▶ 52 Wheels
  - ▶ 56 A4 Interior Colors
  - ▶ 58 S4 Interior Colors
  - ▶ 60 Exterior Colors
  - ▶ 63 Specifications | Configurations
-



# captivate

# A4

The biggest, fastest, most fuel-efficient car in its class is nothing short of captivating.\* At the front, the prominent Singleframe® grille and available Audi xenon plus headlights with LED daytime running lights punctuate the aggressive, low stance of the A4. From the sides, short overhangs create a lean, athletic look while prominent contours add a sense of motion. Below the integrated rear spoiler are the radiant LED taillights that complete the progressive, assertive and thoroughly luxurious look of the Audi A4.

\* Based on 2008 AMCI data.





A4 Premium Plus



A4 Prestige

move



For the fifth year in a row, the 2.0 TFSI® engine was named one of the “10 Best Engines” by *Ward’s Automotive*. There are some very convincing reasons why.

Delivering 211hp and 258 lb.-ft. of torque that pins you in your seat, the 2.0 TFSI engine launches the A4 quattro® from 0 to 60 MPH in a category-best time of just 6.4 seconds. At the same time, the A4 offers class-leading 30 MPG highway fuel economy\*.

The new eight-speed automatic transmission adds to the sporty experience with purposeful and smooth shifts. Also available with a six-speed manual transmission, the A4 proves that performance and efficiency don’t have to be mutually exclusive.

\* *Ward’s Automotive*, December 2009.

† EPA estimate 30 MPG. Your mileage will vary.

# dialed

One turn of the steering wheel is so precise and confidence-inspiring, it's clear the A4 is dialed to perfection. The foundation is the legendary all-wheel drive performance of quattro®. For 30 years, quattro has been redefining traction and handling performance. With a rear-biased 40:60 torque split, quattro dynamically transfers power from front to rear. For the driver, this means true sportscar handling – corners are approached with confidence and relished from entry to apex to exit.

For further control over your drive, the available Audi drive select enhances handling performance by offering 27 distinct driving configurations. The advanced system manages the adaptive suspension, dynamic steering, transmission shift characteristics and throttle response of the A4 to create a thrilling driving experience.

Superior handling is also a product of a dedication to the finest and most applicable materials. By using lightweight aluminum suspension components, unsprung weight is reduced, allowing the suspension to respond more rapidly. Handling is further enhanced by the vehicle's front suspension design. Audi engineers moved the front axle forward to improve agility, ensuring premier handling for every road, every corner and every situation. For the driver looking for sportier handling, the available Sport Package offers a firmer, lower suspension as well as sport seats and high-performance tires for more assertive driving.

Whatever you ask of the A4, it's equipped to deliver it flawlessly.

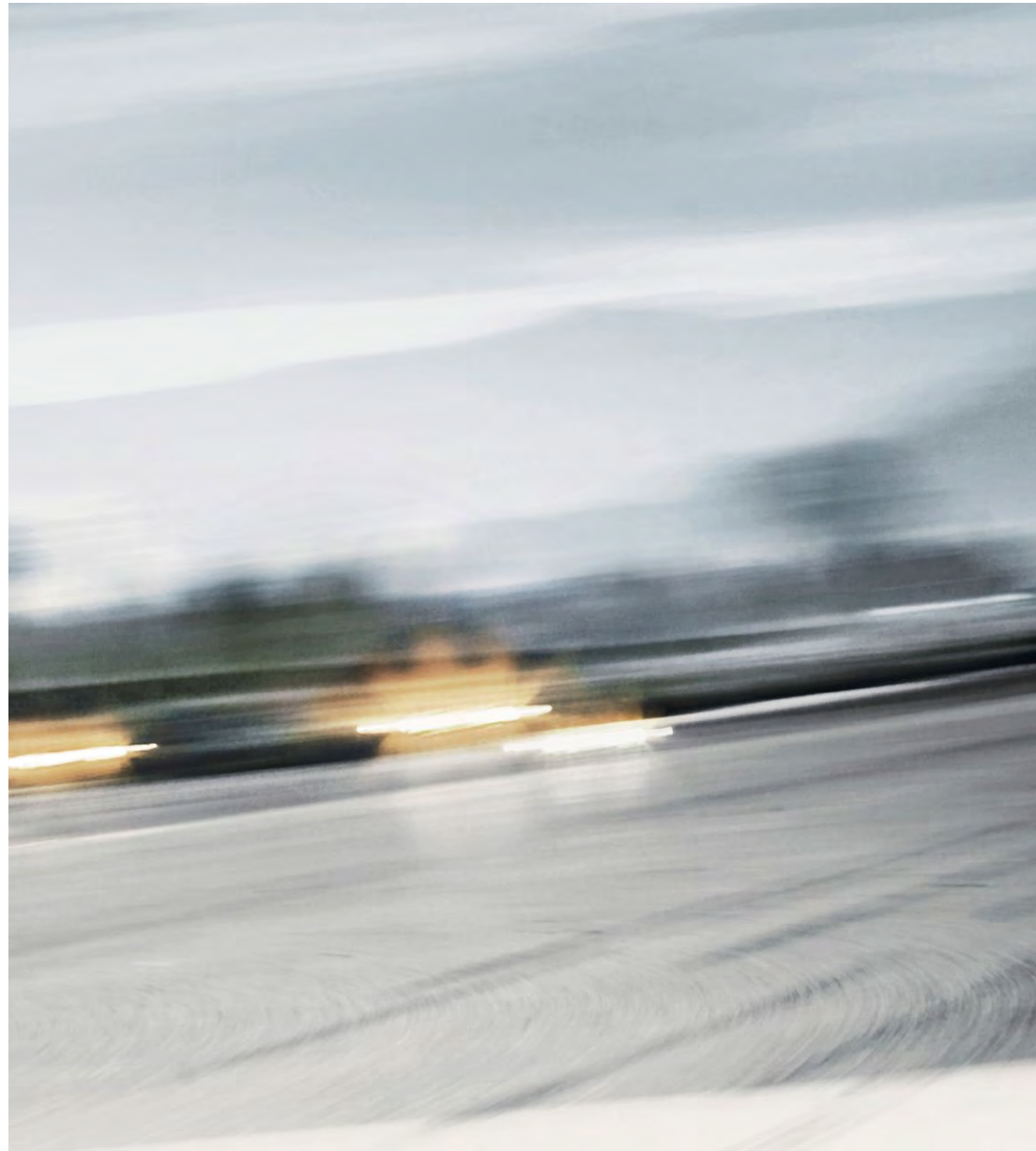



A4 Prestige



# detail

The interior of the A4 is a study in perfection. Every detail, color, material and texture represents a paradigm of harmony. Perhaps no example is finer than the selection of materials. The genuine leather, wood and aluminum are honed and fitted to exacting specifications. In fact, the wood inlays are installed with such precision that only tolerances of less than 0.2 mm are allowed.

The interior's virtually seamless design is also reflected in its ergonomics. Angled decisively toward the driver, the A4 cockpit places a host of technology at your fingertips. Each control is tested to ensure it exhibits the same tactile feel, creating a harmonious experience. From the convenience of the multifunction steering wheel to the intuitive controls of the MMI® operating system, the A4 offers a range of infotainment options to complement the driving experience.







A4 Avant Prestige



# maximize

Take the class-leading design, luxury and performance of the A4 sedan, add the notion of progressive utility, and you have the unique and eye-catching Audi A4 Avant. It surrenders nothing in terms of style and performance and yet adds thoughtful functionality.

Driving the A4 Avant is a visceral experience where you feel as if you and the car are one. Corners are taken with confidence and the potent power under the hood puts a smile on your face. Add the available Sport Package and you've just doubled your exhilaration.

Inside, the 60/40 split folding rear seats offer 50.5 cu. ft. of carrying capacity with the seats folded while the Open Sky panorama sunroof adds a level of luxury and comfort. Outside, the sloped roofline, short overhangs at the wheels and sculpted power tailgate make the A4 Avant as beautiful as it is functional.

# slingshot

---



S4

To be the *Car and Driver* “Best in Test” you have to outperform the competition, and do it flawlessly. The S4 did just that against the BMW 335i. With its 333hp, 325 lb-ft. of torque, 3.0T supercharged V6, quattro® with available Sport Rear Differential, and its responsive and lightweight S tuned five-link

aluminum suspension, the S4 came out on top across the board.

The S4 sprints to 60 MPH in a mere 4.9 seconds with either a manual transmission or the state-of-the-art, rapid-fire, seven-speed S tronic® dual-clutch transmission. It delivers gears as

quickly as you can select them for smooth, uninterrupted power flow.

Applying that power to the road is legendary quattro all-wheel drive enhanced with the available Sport Rear Differential. It varies torque between the rear wheels as needed. Virtually steering the car from the rear wheels,

this creates dynamic traction and true sportscar handling. By directing power to where it's needed most, understeer is eliminated, corners are taken with ease, agility is enhanced and confidence is raised to a new level. In other words, it's exactly the kind of performance the competition can't match.

\* *Car and Driver*, November 2009.





# streamlined

The sleek look of the S4 unequivocally delivers on its superior performance. The distinctive side sills, artfully integrated rear spoiler, Aluminum Optic mirrors and available 19" wheels form a statement of performance. The front and rear splitters add enhanced aerodynamic flow

under the car while giving it an aggressive presence coming and going. From the rear, the quad exhaust offers a deep, resonant growl to accompany the unmistakable look and performance of the S4.



S4 Premium Plus







# access

Just as the exterior of the S4 boldly declares its intentions, the S4 interior follows suit. It is all about maximizing performance by putting you in control. The deep, twelve-way adjustable leather and Alcantara®, or available Silk Nappa leather, sport seats offer the support needed when the true performance potential of the S4 is tapped. Extendable thigh supports offer enhanced comfort, prominent side bolsters help keep you firmly planted and integrated head restraints cushion your head when your right foot gets heavy.

- 1 The S4 offers supportive sport seats that include extendable thigh and power lumbar supports to ensure you're always comfortable.
- 2 The luxurious feel and attention to detail is apparent in the contrast stitching found on the steering wheel, shift boot and seats.

The leather-wrapped, three-spoke, sport steering wheel with Aluminum Optic shift paddles is designed to fit comfortably in your hands, allowing for precise steering inputs. The driver-oriented cockpit helps ensure all the critical controls and information are easily accessible.

Entering the S4, you'll notice special aluminum S4 doorsills and unique S4 gauges. Once inside, available touches, such as Carbon Fiber inlays, confirm the S4 is about pure performance, inside and out.

- 3 The sport seats feature the special embossed S4 logo on the integrated head restraints.
- 4 The S4 interior can be personalized to reflect your style by selecting from a variety of inlays, colors and leathers.

# performance fueled by unconventional thinking



## FSI®

Audi Fuel Stratified Injection, or FSI®, offers the benefits of increased performance and fuel efficiency: FSI direct injection delivers a precise amount of fuel directly into the engine cylinders, as opposed to the engine intake runners. This advanced process helps ensure a more complete combustion, thereby diminishing waste and increasing power.

Additionally, the specially designed piston heads compress the fuel-air mixture in a spiraling motion, creating the most efficient combustion possible. Making the most of

these technologies allows for greater efficiency in the combustion process.

By combining FSI and forced induction, such as a turbocharger or supercharger, the 2.0T and 3.0T engines employ a variation of FSI called TFSI®. The principle and benefits are identical. TFSI equipped engines take advantage of significantly higher compression ratios and cylinder pressure, thus fully atomizing fuel and optimizing boost response. The compressor condenses the air flowing into the engine, allowing more air into the cylinder and therefore, more power from each ignition.

A forced-induction engine produces greater power than a similar engine without it, significantly improving the engine's power-to-weight ratio. Consequently, Audi is able to use smaller, more efficient engines and achieve similar power and performance results typically found in larger, less-fuel-efficient engines.

The beauty of FSI and TFSI is that they work at any RPM, maximizing efficiency and generating responsive and optimal power during all driving conditions.

## Audi Valvelift System

Audi valvelift system helps elevate the performance characteristics of variable valve timing. The result is smooth power buildup, instantaneous throttle response and up to a 7 percent reduction in fuel consumption.

Audi valvelift system intelligently varies the lift and duration of engine exhaust valves in response to engine load and power needs. Optimizing air management, Audi valvelift system helps create maximum torque across a broad range of RPM without sacrificing efficiency.

# pulse



3.0 liter TFSI® engine with 2995 cc of displacement

Maximum 333hp @ 5500 RPM

Maximum 325 lb-ft. of torque @ 2900 RPM

Specific power output of 111hp per liter of displacement

FSI® direct injection with up to 120 bar of pressure

A high compression ratio of 10.3:1

0-60 MPH in 4.9 seconds

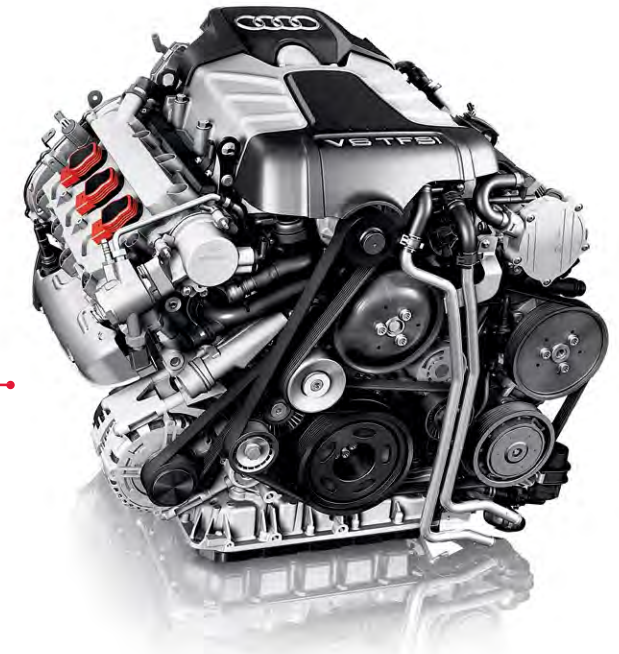

## 2.0 TFSI®

The Audi 2.0 liter turbocharged DOHC engine was named one of Ward's "10 Best Engines" for the fifth year in a row as well as "International Engine of the Year" for the fifth time.†

Years ahead of the competition, it combines Audi valvelift system, variable valve timing, TFSI® direct injection and turbocharging for more power and greater efficiency. The 2.0 TFSI was the first engine to combine gasoline direct injection with turbocharging in large-scale production. Producing 211hp and 258 lb-ft. of torque, it has been the engine of choice for more than 1.3 million Audi drivers worldwide.

## 3.0 TFSI®

The Audi 3.0 liter TFSI engine has been named one of Ward's "10 Best Engines" in its first year of production. The 3.0 liter, all-aluminum V6 benefits from the combination of FSI direct injection and supercharging to create 333hp and 325 lb-ft. of torque. The impressive torque is generated over a wide range, from 2900 to 5300 RPM, making full power usable at any speed. The four-vane Roots-style supercharger makes the 3.0 liter V6 exceptional. The potent combination of FSI with supercharging allows Audi to achieve V8 power and torque with the efficiency of a V6.†



\* EPA estimate 30 highway MPG. Your mileage will vary.

† Based on 1.8 to 2.0 liter category.

‡ EPA estimate 28 highway MPG. Your mileage will vary.

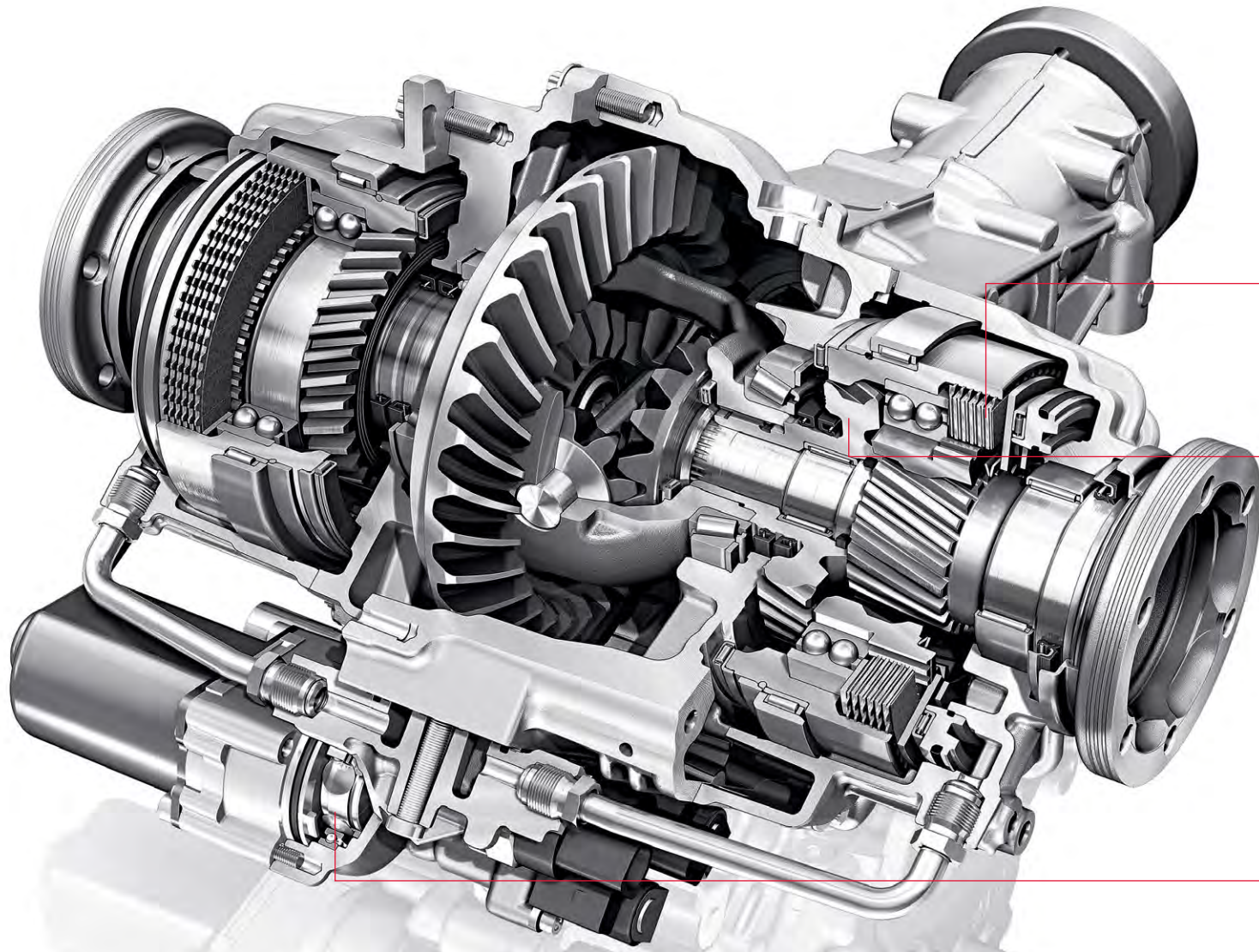

**Clutch in Power Flow:**  
Minimal drag losses  
Highest actuation dynamics  
Optimal control accuracy

**Overdrive Speed Difference  
via Internal Step Gear:**  
Compact design  
Minimal weight  
Optimal efficiency  
Instantaneous response

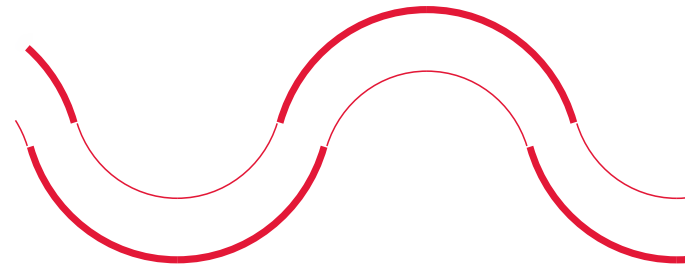

**Hydraulic Actuation:**  
Optimal control  
Highest power density

get ready, this is where  
it becomes visceral



# awe



The concept is ingenious, the solution brilliant. Often imitated, nothing drives like quattro®, the world's most innovative all-wheel drive system. It's a technology that we've been developing for 30 years. And the competition? They're just now beginning to realize what we've known for three decades.

For you, quattro means unmatched traction and confidence in less-than-ideal driving conditions and unequalled performance all other times.

Permanent all-wheel drive systems are not created equal. And they certainly don't

perform that way either. quattro is essentially a mechanical system devised around a torque-sensing, self-locking, center differential that shifts torque instantaneously to where it's needed. This means quattro is adjusting power between front and rear axles more than 100 times a second, ensuring torque is delivered to the wheels where traction exists.

In normal driving situations, quattro distributes the power between each axle by sending 40 percent to the front wheels and 60 percent to the rear wheels, enhancing the driving dynamics while maintaining optimum control. Constantly

assessing grip, quattro helps ensure the best possible combination of traction and handling, regardless of the road conditions.

quattro with Sport Rear Differential additionally senses which rear wheel to deliver an optimum level of torque. Specifically, it directs most of the power to the outer rear wheel to help steer the car through the corner. This reduces understeer, common among other all-wheel drive systems, and creates the true sportscar handling found in an Audi. The difference between other all-wheel drive systems and quattro is nothing less than dramatic.

What you experience behind the wheel is confidence-inspiring handling. Curves are relished. Rain and snow are greeted with relative indifference. And every drive is an experience in performance bliss.



30  
years of quattro®

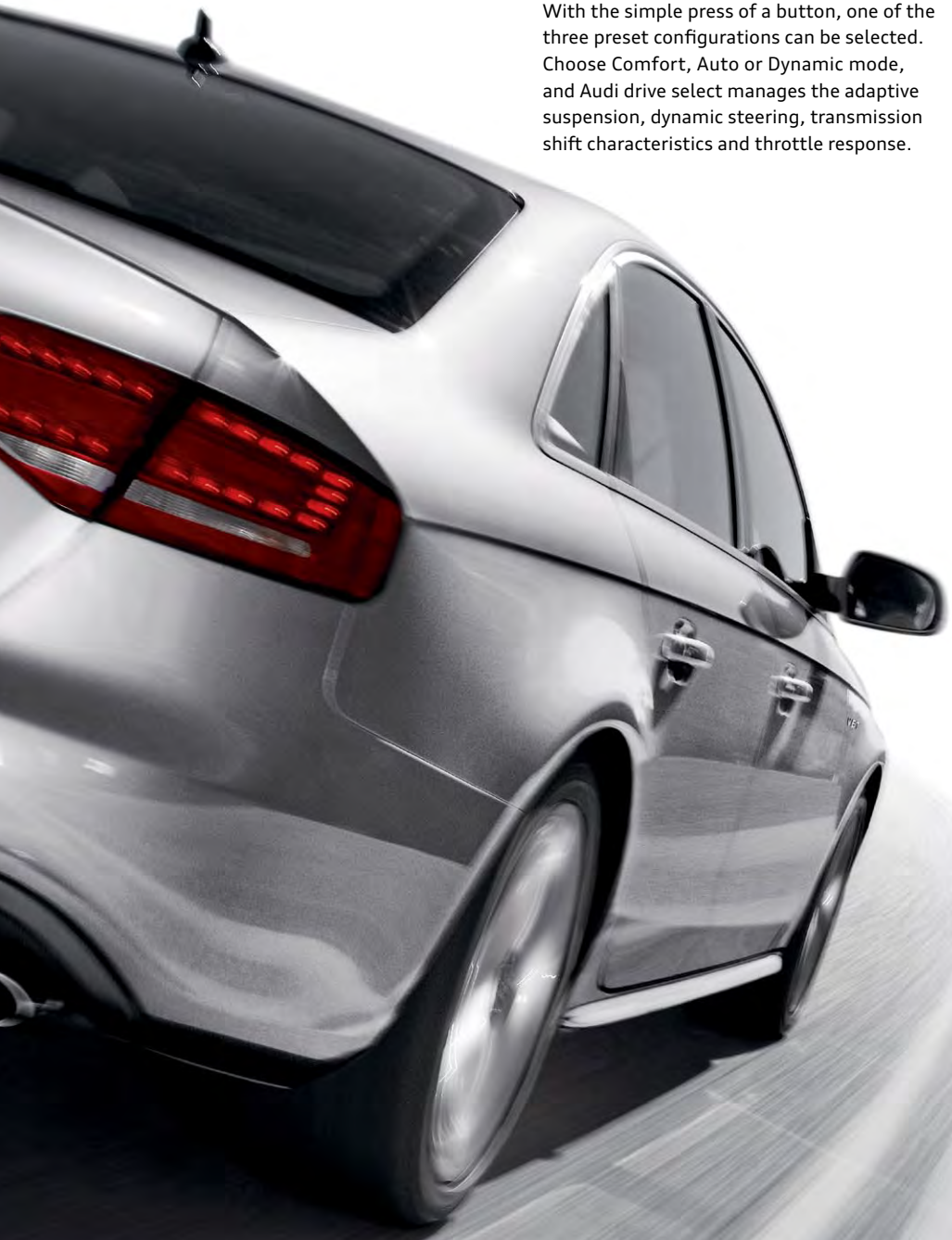

With 27 available vehicle handling and performance combinations, Audi drive select is another example of Audi progressive technology.

Whether you prefer the smooth, luxurious ride of Comfort mode or the more direct and firmer responses of Dynamic mode, Audi drive select allows you to tailor the vehicle to your liking. With the simple press of a button, one of the three preset configurations can be selected. Choose Comfort, Auto or Dynamic mode, and Audi drive select manages the adaptive suspension, dynamic steering, transmission shift characteristics and throttle response.

Comfort mode creates a more pliant ride by reducing the stiffness of the suspension, adjusting the throttle for smoother off-the-line acceleration and promoting earlier transmission upshifts while reducing steering resistance. Comfort mode is ideal for casual in-town driving, poor road surfaces or anytime the driver desires a more relaxed and comfortable ride.

By selecting Dynamic mode, Audi drive select accommodates more spirited driving by allowing later transmission upshifts at higher RPMs, thereby capitalizing on the available engine power. Dynamic mode also stiffens the suspension, tightens the steering and makes the engine's throttle response more crisp. All of this adds up to a more visceral driving experience that will have you looking for the next sweeping bend in the road.

In Auto mode, Audi drive select adapts the vehicle dynamics according to driver inputs. In normal, around-town driving, the system behaves similar to how it does in Comfort mode, offering a comfortable and pliant experience. When the road opens up and the driving gets exciting, Audi drive select stiffens the suspension, tightens the steering and allows for upshifts to happen at higher RPMs. Auto mode is ideal for all-around driving and when there's a mixture of driving environments.

Adding to the versatility of Audi drive select, the Individual mode allows for personalized settings for throttle response, transmission shift characteristics, suspension and steering dynamics. Setting up the variables is intuitive and simple via the MMI® system. With the Individual mode managing 27 personalized variations, you can configure the vehicle's driving dynamics according to your precise preferences.

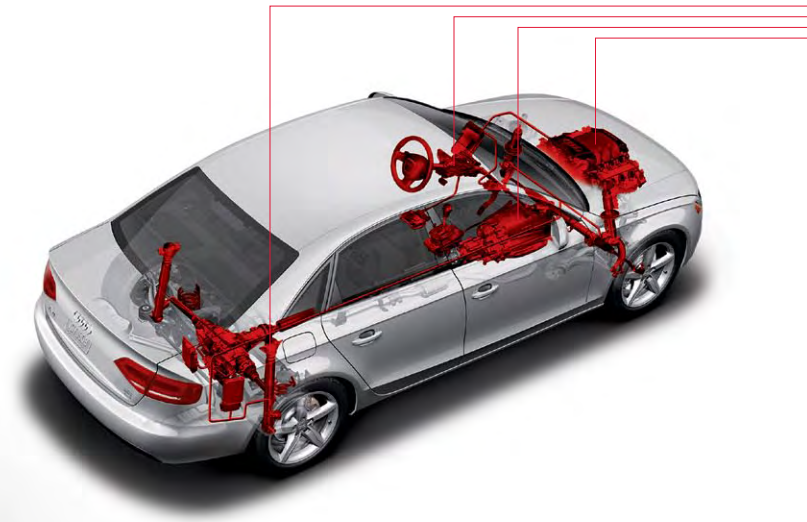

# versatile

your Audi, your way



## Engine

Audi drive select adjusts the engine's throttle response to ensure acceleration is smooth in Comfort mode, spirited in Dynamic mode and senses your driving style in Auto mode, responding and adjusting accordingly.

## Transmission

Similar to altering the acceleration characteristics, Audi drive select adjusts the shift points of the transmission according to the mode selected. In Dynamic mode, Audi drive select allows the transmission to upshift later, accessing the increase in horsepower at higher RPM. In Comfort mode, Audi drive select programs the transmission to shift earlier at lower RPM, resulting in a more luxurious driving experience.

## Suspension

Pliant and smooth or firm and precise? Depending on the chosen Audi drive select mode, the suspension responds as desired. Thanks to a unique algorithm for each mode, the response to road imperfections, speed, cornering and overall suspension travel is tailored individually for the Comfort, Auto and Dynamic settings.

## Servotronic® Steering

Servotronic® is speed-dependent power steering in which the amount of power assist provided is dictated by road speed, providing even more comfort and convenience for the driver. The amount of power assist is greatest at low speeds, making it easier to maneuver the car. At higher speeds, an electronic-sensing system gradually reduces the level of power assist, creating a more dynamic steering sensation. Audi drive select enhances Servotronic steering by also varying the steering ratio according to vehicle speed. Therefore, during in-town driving, the steering is light and direct, but firmer and more precise at higher speeds.

# connected

---

customizing nearly every aspect  
of your driving experience

## ■ Car Setup

The personalization of your vehicle settings can be managed through the MMI® system, enabling you to set your preference for daytime running lights settings, central locking features, the audio system, date and time format, and windshield wiper settings, as well as monitor your service intervals. Individual preferences are all accessed, modified and stored via MMI.

When equipped with Audi drive select, the MMI system enables you to choose your preferred settings for ride comfort and handling.

## ■ Radio

In addition to offering analog, HD Radio™ Technology and SIRIUS® Satellite Radio tuning, MMI allows you to tune the receiver by scrolling through your preset radio stations; adjust the audio settings, and customize the listening experience by tailoring the speaker output. You can also preview what's playing on SIRIUS Satellite Radio stations without changing the station you're currently listening to.

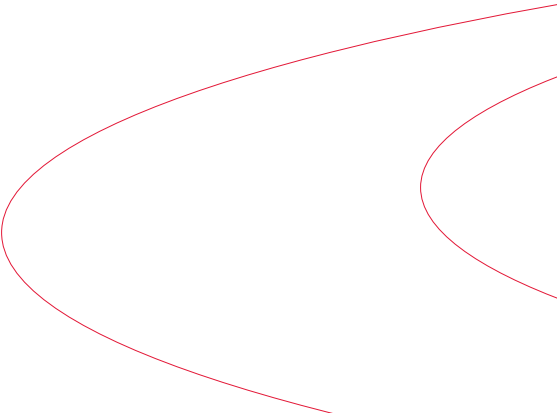
A red abstract graphic consisting of several overlapping, curved lines that form a shape resembling a stylized 'e' or a partial oval, located in the bottom right corner of the page.

The easy-to-use MMI® (Multi Media Interface) allows you to access various vehicle systems, such as navigation, radio, telephone, voice activation and car setup, to optimize your driving experience. Two major components make the system intuitive.

First, the MMI control knob with integrated joystick, located near the shift lever, allows you to navigate various system functions easily without diverting your eyes from the road. Secondly, voice

control offers an additional method to interface with the MMI system. By simply speaking the desired command, the system recognizes the driver's instructions. In both cases, system inputs, selections and options are displayed on the high-definition MMI screen.

Audi was the first manufacturer to use an automotive-grade NVIDIA® chip in the navigation system to offer high-quality on-screen graphics.

The result is smooth, zoom-in and zoom-out functionality and crisp, 3D graphics of buildings and topography for easier navigation.

At its core, the MMI system has a central media and communications computer that controls the navigation functions, the Bluetooth® universal mobile phone preparation, voice control, and media with integral DVD drive and a 40-GB hard drive. When equipped with the Audi music

interface (AMI), an iPod® and other mobile media players can be accessed via the MMI system for easy music selection.

From music to navigation and more, the MMI system is your pathway to truly personalizing your driving experience.

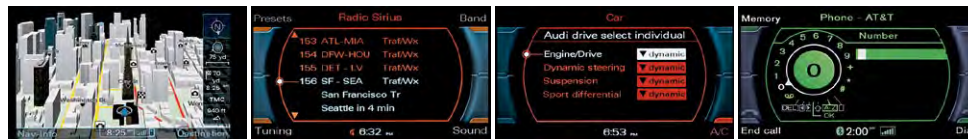

### Media

Managing your entertainment options with the MMI system is effortless. With a simple push of a button, MMI allows you to select among the radio tuner, CD/DVD player, AMI or the integrated hard drive. The hard drive allows you to preload 10-GB of personal audio files. Using the control knob, the media source menu and music options are easily viewed on the high-definition MMI screen. Once a selection is made, the track name is displayed.

### Voice Control

Building on the convenience of the MMI system, voice control allows you to operate the main functions, such as telephone and directory, with voice commands. The navigation system is also voice-enabled, allowing for town and street names to be spoken as a navigation destination without having to spell them out letter by letter. The same capability exists for the telephone feature.

### Telephone

The MMI system offers integrated Bluetooth® technology to support more than one Bluetooth-compatible mobile phone. The system allows the driver or passengers to seamlessly switch among the supported phones and their listings as well as the contacts stored in the MMI system.

### 3D Navigation

The map displayed on the MMI screen is shown in a three-dimensional topographical format. For added convenience, a large number of cities are displayed in a detailed, three-dimensional format, visually articulating building and road specifics for easier readability.



# confidence

we've got your back, front, sides and top

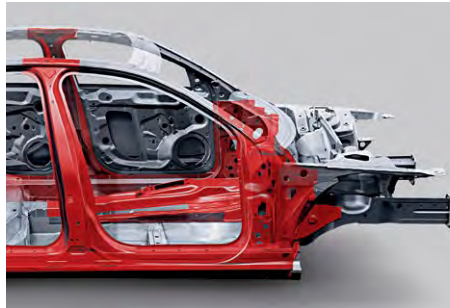

Audi has always held firm the belief that prevention is the best safety feature of all. And the Audi A4 and S4 offer an abundance of features designed to help keep you out of harm's way. For instance, the Electronic Stabilization Program (ESP®) helps keep the vehicle traveling in its intended direction by utilizing ABS, the traction control of ASR and the electronic brake force distribution of EBD.

Audi has implemented a number of ingenious features to help maximize braking effectiveness. In wet conditions, the brake disc wiping system gently pulses the brakes to help dissipate water buildup. Keeping the discs as dry as possible helps promote the most effective braking. Additionally,

the brake assist system is able to detect an attempt at full braking and apply full stopping power when required. The advantage is that braking distance is significantly reduced.

Inside, the Audi safety systems prepare for the worst once the brake assist system is engaged. The safety belt pre-tensioners are activated for all occupants, and lock the safety belts in place. This is intended to help keep passengers in the safest position in the event of a collision.

When prevention isn't enough, the combination of crumple zones and high-strength steel helps deliver a tremendous level of protection for the

driver and passengers. Crumple zones, at the front and rear of the vehicle, are designed to dissipate the energy and force of a collision by deforming upon impact. The high-strength steel used in and around the occupant cell is designed to protect the integrity of the passenger compartment and those within it.

The six standard, second-generation airbags\* provide an additional measure of safety. They include front-impact airbags for the driver and passenger and are designed to help protect the head. Seat-mounted, side-impact airbags for the front seat occupants are designed to help protect

the thorax in a collision. And the side-curtain airbags offer front and rear occupants head protection in the event of a side collision or rollover.

Reacting to rear collision forces, the head restraints help cradle the occupant's head in an effort to reduce the likelihood of a whiplash injury.

Everything comes together to reinforce our commitment to all-encompassing safety.



We have 30 years of experience in developing the world's most sophisticated all-wheel drive system. The result is quattro®. It helps maximize traction by automatically adjusting power to each wheel, making the car feel planted – regardless of conditions. Combine ESP and race-bred braking technology, and you'll feel a level of confidence you've never experienced before.

- ▶ quattro helps increase your margin of safety by helping you maintain maximum traction in a variety of weather conditions.
- ▶ ESP helps ensure your vehicle maintains the intended direction of travel by continuously adjusting a number of drivetrain variables.
- ▶ Four-wheel disc brakes with brake disc wiping offer optimal braking in all kinds of weather.

\*Airbags are supplemental restraints only and will not deploy in all crash circumstances. Always use safety belts and seat children in the rear, using restraint systems appropriate for their size and age. This is a dramatization and does not depict what will happen in an accident. All bags will not inflate in real world accidents and if multiple bags deploy they will be in various stages of inflating/deflating and will never all be inflated at the same time.

# A4 Premium



## A4 Premium

- 1 Leather seating surfaces** | High-quality, sumptuous leather complements the vehicle seat design while enhancing the overall interior style.
- 2 Sunroof** | The sunroof provides passengers with a light-filled driving experience. [Open Sky panorama sunroof available on Avant only]
- 3 17" seven-spoke wheels with 225/50 all-season tires** | The seven-spoke wheel is a refined design that complements the sport-inspired style of the A4. The wheels come equipped with all-season tires offering year-round performance and comfort.
- 4 Four-spoke, leather-wrapped steering wheel** | The four-spoke, leather-wrapped steering wheel provides a sporty look and feel, enhancing the A4 driving experience.
- 5 Power front seats with driver lumbar support** | The power front seats allow the driver and passenger to electronically adjust the seats' forward/backward position, height, angle of seat cushion and seatback, and the driver's lumbar support.
- 6 Audi concert radio with SIRIUS® Satellite Radio** | This stereo system integrates 180 watts of power, an SD card slot, MP3 capability, a CD player and auxiliary input for easy access to a variety of music devices. Aside from exceptional sound quality, the system also features the Radio Data System (RDS), which displays several types of FM radio information, as well as the information from the standard SIRIUS® Satellite Radio. SIRIUS offers commercial-free music, talk and more.
- 7 Automatic climate control** | The climate control system allows the driver and passengers to enjoy an ideal level of heating or cooling via the center console. A light sensor on the dashboard adjusts the system based on the sun's intensity.
- 8 Halogen headlights with daytime running lights** | Halogen headlights help enhance safety by illuminating a wide section of the road.

Features listed are standard on the Premium model unless otherwise noted.

+ FEATURE NOT SHOWN

## A4 Premium Plus



## A4 Premium



## A4 Premium Plus

**5 Audi xenon plus headlights with LED daytime running lights** | The signature LED daytime running lights and high-intensity headlights not only add a distinct look to the vehicle, they also help improve visibility while using half of the energy of conventional bulbs.

**6 Auto-dimming interior mirror with compass** | The rearview mirror with automatic dimming recognizes glaringly bright beams behind the car and darkens the mirror automatically. An electronic control unit varies the darkening effect quickly and continuously according to actual ambient light conditions. Vehicle direction is displayed through a digital compass in the corner of the mirror.

**7 Audi music interface** | This connective technology offers intelligent integration with the iPod® and iPhone®. Any iPod Generation 4 and higher may be connected through the glove box, providing full iPod controls on the MMI® screen. This feature allows connection of a USB flash drive or a conventional auxiliary audio input as well.

**8 Heated front seats** | With a convenient touch of a button, the multilevel seat-heating system warms the entire surface of the seat.

**9 17" ten-spoke wheels with 245/45 all-season tires** | The motorsport-inspired 17" wheels offer a visual complement to the overall vehicle design. Additionally, year-round performance is enhanced with all-season tires, helping ensure a safe and comfortable ride on virtually all surfaces.

**\* Bluetooth® mobile phone preparation** | The advanced technology of the Audi A4 allows you to conveniently access your Bluetooth®-enabled phone's features via the MMI operating system, allowing for easy, intuitive, hands-free communication. For specific compatibility and operation instructions, refer to [audiusa.com/bluetooth](http://audiusa.com/bluetooth) or contact your local Audi dealer for the latest listing of compatible phones.

**\* HomeLink®** | HomeLink® is integrated into the overhead controls and uses a simple three-button system to control garage doors, gates and even lights in your home.

**\* LED taillights** | LED lights are superior to conventional bulbs, thanks to faster activation speeds and bright light emissions. In addition, they can last an entire vehicle lifetime and consume up to 50 percent less energy while adding a signature look to your Audi. [A4 sedan only]

**\* Three-zone automatic climate control** | The driver, front passenger and rear passenger can select and control their desired level of heating or cooling via the center console. A light sensor on the dashboard adjusts the system based on the sun's intensity.

Features listed are standard on the Premium Plus model unless otherwise noted.

+ FEATURE NOT SHOWN

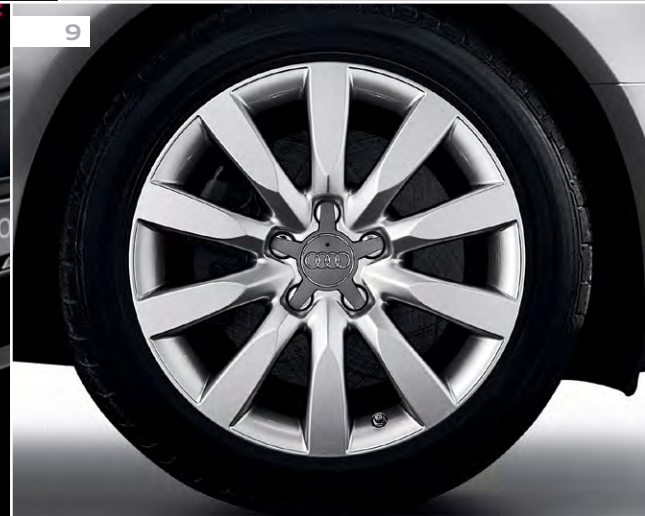

A4 Prestige

1



2



3



4



5



## A4 Prestige

## A4 Packages

- <sup>1</sup> **18" five-spoke wheels with 245/40 all-season tires** | The refined simplicity of the five-spoke wheel complements the graceful lines of the vehicle. Paired with all-season tires, they help ensure a safe and comfortable ride on virtually all surfaces.

---

- <sup>2</sup> **Audi MMI® Navigation plus** | Audi MMI® Navigation plus features a 7" full-color LCD screen and MMI control logic. The A4 comes equipped with the latest generation of MMI, powered by a 40-GB hard drive and an NVIDIA® processor to enhance graphics. This generation MMI offers a color driver information system, real-time traffic, 3D topography graphics that include the buildings in many cities and the crystal clear digital AM and FM sound of HD Radio™ Technology with over 1,000 new stations. Also included is voice control for navigation and telephone functions.

---

- <sup>3</sup> **Auto-dimming exterior mirrors** | The side exterior mirrors recognize bright lights behind the car and darken the mirror glass automatically.

---

- <sup>4</sup> **Audi advanced key** | With this advanced keyless entry system, your vehicle can be locked or unlocked and started without removing the key from a pocket or purse. When the key is present, doors can be unlocked, the steering wheel can be released and the vehicle can be turned on without inserting the key into the ignition.

---

- <sup>5</sup> **Bang & Olufsen® Sound System** | The 14 speakers and 505 digitally amplified watts with surround sound reproduction fill the interior of the vehicle with crisp, premium sound. Microphone-based noise compensation ensures optimum sound under varying road conditions and speeds.

---

- <sup>6</sup> **Driver memory** | At the touch of a button, your driver seat position and side view mirror positions are set to your desired levels. This feature stores up to two driver settings.

---

- <sup>7</sup> **Audi parking system with rearview camera** | When reversing, the rearview camera provides real-time viewing of the rear parking area on the MMI screen, helping you see potentially hazardous objects in parking scenarios. Ultrasonic rear parking sensors measure the distance to the nearest object and audibly warn you when the distance becomes unsafe.

Features listed are standard on the Prestige model unless otherwise noted.

+ FEATURE NOT SHOWN



8



## A4 Prestige

1



2



4



## A4 Packages

**18" Sport Package** | For more performance-oriented handling characteristics, the 18" Sport Package includes a specially tuned, firmer suspension with an assertive stance and sport seats that offer greater lateral support. The 18" sport wheels have a bold, aggressive design and come equipped with 245/40 summer performance tires. Tiptronic<sup>®</sup> models equipped with the Sport Package have shift paddles allowing effortless, race-inspired gear shifting so you can keep your hands on the three-spoke steering wheel. [Premium and Premium Plus only]

**19" Sport Package** | The 19" Sport Package offers the same suspension, seats, shift paddles and steering wheel as the 18" Sport Package, but comes equipped with dynamically designed 19" seven-twin-spoke wheels equipped with 255/35 summer performance tires. [Prestige only]

**S line<sup>®</sup> Package** | The exterior S line<sup>®</sup> features of the A4 include 19" S line seven-twin-spoke wheels with the superior handling of 255/35 summer performance tires. Sport suspension is included to help improve driving dynamics. Exterior trim elements include the iconic Singleframe<sup>®</sup> grille, side valances, S line-specific front and rear bumpers, and badging. Inside, elements include Brushed Aluminum doorsills with S line badging and elegant Brushed Aluminum decorative inlays extending across the center console, doors and dashboard. The S line designation extends to the three-spoke, leather-wrapped steering wheel featuring special perforated leather and S line badge. Also included are S line sport seats with leather and perforated Alcantara<sup>®</sup> seat inserts, and the perforated shift knob. [Prestige only]

**Titanium Sport Package** | Inspired by the Audi motorsport legacy, this package includes a number of aesthetic and performance enhancements. Exterior elements include black roof rails on A4 Avant, black window trim, titanium-finish wheels and the iconic black Singleframe<sup>®</sup> grille. Inside, the Titanium Sport Package carries through the performance-look with a black headliner, Piano Black inlays and supportive sport seats. The enhanced handling performance comes from the sport suspension that gives your Audi a low, assertive stance. [Premium Plus and Prestige only]

**Audi MMI<sup>®</sup> Navigation plus Package** | The Audi MMI<sup>®</sup> Navigation plus Package features a 7" full-color LCD screen and MMI control logic. The A4 comes equipped with the latest generation of MMI, powered by a 40-GB hard drive and an NVIDIA<sup>®</sup> processor to enhance graphics. This generation MMI offers a color driver information system, real-time traffic and voice control for navigation and telephone functions. Additionally, it offers 3D topography graphics that include the buildings in many cities and the crystal clear digital AM and FM sound of HD Radio<sup>™</sup> Technology with over 1,000 new stations. Also included is the Audi parking system with a rearview camera for real-time viewing of the parking area with rear ultrasonic parking sensors measuring the distance to the nearest object and audibly warning you when the distance becomes unsafe. [Premium Plus only]

**Bluetooth<sup>®</sup> and HomeLink<sup>®</sup> Package** | The advanced technology of the Audi A4 allows you to conveniently access your Bluetooth<sup>®</sup>-enabled phone's features via the MMI operating system, allowing for easy, intuitive hands-free communication. For specific compatibility and operation instructions, refer to [audiusa.com/bluetooth](http://audiusa.com/bluetooth) or contact your local Audi dealer for the latest listing of compatible phones. HomeLink<sup>®</sup> is integrated into the overhead controls and uses a simple three-button system to control garage doors, gates and even lights in your home. [Premium only]

\* See page 53 for important safety information regarding summer performance tires.

+ FEATURE NOT SHOWN



8



## A4 Options

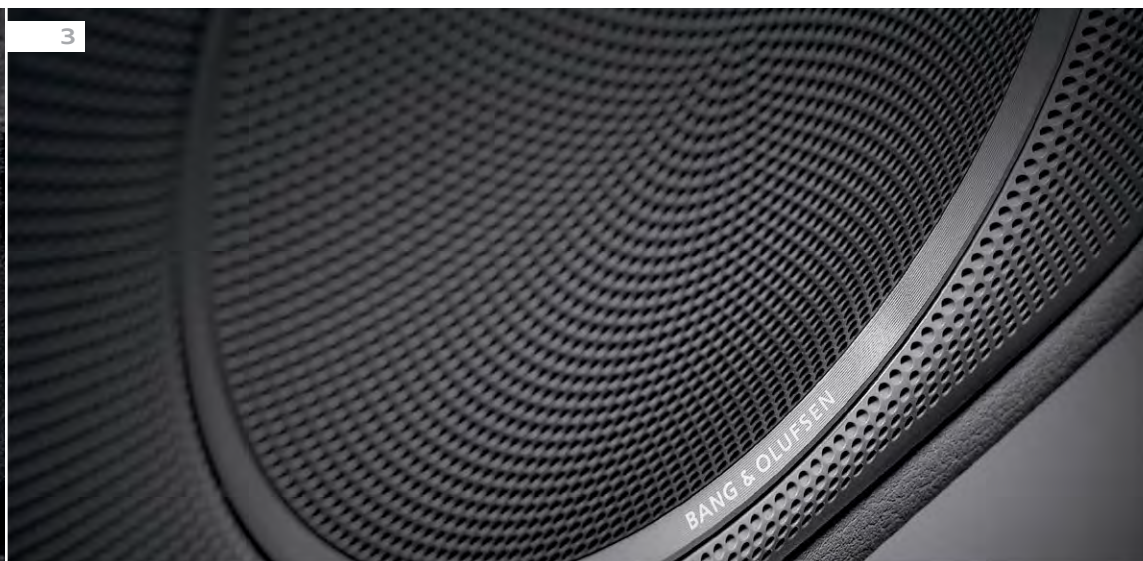

## A4 Options

- <sup>1</sup> **Audi music interface** | This connective technology offers intelligent integration with the iPod® and iPhone®. Any iPod Generation 4 and higher may be connected through the glove box, providing full iPod controls on the MMI® screen. This feature allows connection of a USB flash drive or a conventional auxiliary audio input as well. [Premium only]
- <sup>2</sup> **Heated front seats** | The seat-heating system is designed to heat the entire surface of the seat; warming is initiated with a convenient control dial. [Premium only]
- <sup>3</sup> **Bang & Olufsen® Sound System** | The 14 speakers and 505 digitally amplified watts with surround sound reproduction fill the interior of the vehicle with crisp, premium sound. Microphone-based noise compensation ensures optimum sound under varying road conditions and speeds. [Premium Plus only]
- <sup>4</sup> **Audi side assist** | Active at speeds over 19 MPH, Audi side assist helps monitor blind spots and fast-approaching vehicles at a range of 150 ft. When a vehicle is present within the monitored area, the system warns you via LED lights in the exterior mirrors. [Prestige only]
- <sup>5</sup> **Audi adaptive cruise control** | This system enhances conventional cruise control by monitoring the distance to the vehicle ahead via radar sensors. The system automatically reduces or resumes speed to help maintain the safe distance selected by the driver. [Prestige only]
- <sup>6</sup> **Rear side airbags\*** | Rear side airbags offer the second-row outboard occupants enhanced impact protection.
- <sup>7</sup> **Audi drive select** | Exclusive to Audi, this system provides advanced control of the vehicle's adaptive suspension, dynamic steering, transmission shift characteristics and engine response. The system offers 27 distinct driving configurations, where drivers can configure vehicle drive characteristics exactly to their liking with their choice of Comfort, Auto, Dynamic or Individual settings. [Prestige only]

\* Airbags are supplemental restraints only and do not deploy in all crash circumstances. Always use safety belts and seat children in the rear, using restraint systems appropriate for their size and age.

+ FEATURE NOT SHOWN

## S4 Premium Plus



## A4 Options



## S4 Premium Plus

- 5 18" five-parallel-spoke S design wheels with 245/40 summer performance tires\*** | The motorsport-inspired 18" wheels offer a distinct performance look, while the summer performance tires help to improve handling and driving dynamics.
- 6 Dual-exhaust quad tailpipes** | This performance exhaust system features exclusive quad oval tailpipes that create a rich exhaust note and leave no doubt about the power contained under the hood of the S4.
- 7 LED taillights** | LED lights are superior to conventional bulbs, thanks to faster activation speeds and bright light emissions. In addition, they can last an entire vehicle lifetime and consume up to 50 percent less energy while adding a signature look to your Audi.
- 8 HomeLink®** | HomeLink® is integrated into the overhead controls and uses a simple three-button system to control garage doors, gates and even lights in your home.
- + Bluetooth® mobile phone preparation** | The advanced technology of the Audi S4 allows you to conveniently access your Bluetooth®-enabled phone's features via the MMI® operating system, allowing for easy, intuitive, hands-free communication. For specific compatibility and operation instructions, refer to [audiusa.com/bluetooth](http://audiusa.com/bluetooth) or contact your local Audi dealer for the latest listing of compatible phones.
- + Audi xenon plus headlights with LED daytime running lights** | The signature LED daytime running lights and high-intensity headlights not only add a distinct look to the vehicle, they also improve visibility while using half of the energy of conventional bulbs.
- + Auto-dimming interior mirror with compass** | The rearview mirror with automatic dimming recognizes glaringly bright beams behind the car and darkens the mirror automatically. An electronic control unit varies the darkening effect quickly and continuously according to actual ambient light conditions. Vehicle direction is displayed through a digital compass in the corner of the mirror.
- + Heated front seats** | With a convenient touch of a button, the multilevel seat heating system warms the entire surface of the seat.
- + S4 sport seats** | The sport seats offer greater lateral support thanks to the more prominent side bolsters. The seat functions include electric lumbar support, extendable thigh supports and integrated head restraints. The use of high-quality leather with Alcantara® inserts in the interior of the S4 is standard, which adds to the elegant, dynamic and sporty driving experience. The stylish contrast stitching, combined with the available Silk Nappa leather, adds to the progressive style.
- + S4 design elements** | The quality of materials and craftsmanship of the S4 interior is highlighted by sporty Brushed Aluminum decorative inlays extending across the dash and doors as well as S4 doorsill inlays. The S4 is also equipped with a three-spoke, multifunction steering wheel with Aluminum Optic shift paddles for S tronic®.

Features listed are standard on the Premium Plus model unless otherwise noted.

\* See page 53 for important safety information regarding summer performance tires.

+ FEATURE NOT SHOWN

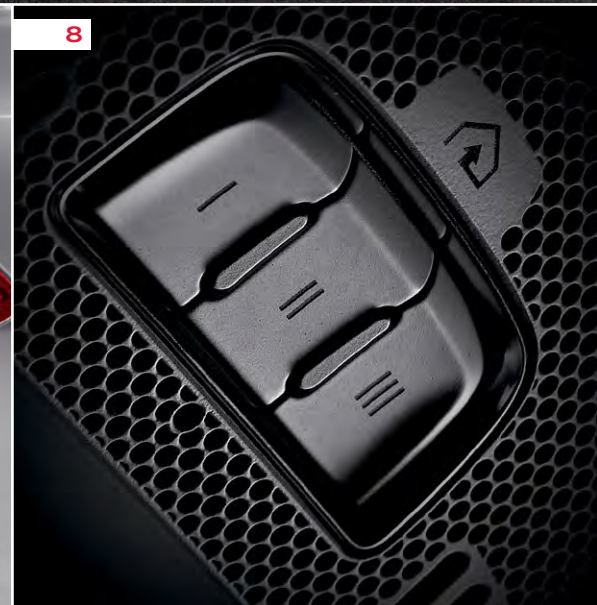

S4 Prestige



**1. 19" five-tri-spoke wheels with 255/35 summer performance tires\*** | The aggressive look of the 19" wheels is complemented by the summer performance tires that offer enhanced handling.

**2. Auto-dimming exterior mirrors** | The side exterior mirrors recognize bright lights behind the car and darken the mirror glass automatically.

**3. Driver memory** | At the touch of a button, your driver seat position and side view mirror positions are set to your desired levels. This feature stores up to two driver settings.

**4. Audi MMI® Navigation plus** | Audi MMI® Navigation plus features a 7" full-color LCD screen and MMI control logic. The S4 comes equipped with the latest generation of MMI, powered by a 40-GB hard drive and an NVIDIA® processor to enhance graphics. This generation MMI offers a color driver information system, real-time traffic, 3D topography graphics that include the buildings in many cities and the crystal clear digital AM and FM sound of HD Radio™ Technology with over 1,000 new stations. Also included is voice control for navigation and telephone functions.

**+ Audi advanced key** | With this advanced keyless entry system, your vehicle can be locked or unlocked and started without removing the key from a pocket or purse. When the key is present, doors can be unlocked, the steering wheel can be released and the vehicle can be turned on without inserting the key into the ignition.

**+ Bang & Olufsen® Sound System** | The 14 speakers and 505 digitally amplified watts with surround sound reproduction fill the interior of the vehicle with crisp, premium sound. Microphone-based noise compensation ensures optimum sound under varying road conditions and speeds.

**+ Audi parking system with rearview camera** | When reversing, the rearview camera provides real-time viewing of the rear parking area on the MMI screen, helping you see potentially hazardous objects in parking scenarios. Ultrasonic rear parking sensors measure the distance to the nearest object and audibly warn you when the distance becomes unsafe.



Features listed are standard on the Prestige model unless otherwise noted.

\* See page 53 for important safety information regarding summer performance tires.

+ FEATURE NOT SHOWN

## S4 Prestige



## S4 Options

**5 Bang & Olufsen® Sound System** | The 14 speakers and 505 digitally amplified watts with surround sound reproduction fill the interior of the vehicle with crisp, premium sound. Microphone-based noise compensation ensures optimum sound under varying road conditions and speeds. [Premium Plus only]

**6 quattro® with Sport Rear Differential** | Continuing a legacy of all-wheel drive performance, quattro® with Sport Rear Differential dynamically varies torque between the rear wheels for enhanced cornering agility and traction performance.

**7 Silk Nappa leather** | The impeccable quality of the Silk Nappa leather with contrast stitching offers a luxurious feel, ensuring optimal comfort no matter the driving scenario.

**\* Adaptive cruise control** | Adaptive cruise control monitors distance to the vehicle in front via radar sensors and automatically reduces speed, as well as resumes speed to maintain the driver-selected safe distance. [Prestige only]

**\* Audi side assist** | Active at speeds over 19 MPH, Audi side assist monitors blind spot areas and fast-approaching vehicles at a range of 150 ft. When a vehicle is present within the monitored area, the system warns you via LED lights in the exterior mirrors. [Prestige only]

**\* Rear side airbags\*** | The S4 offers rear side airbags which can help reduce the risk of severe injuries in certain collisions.

\* Airbags are supplemental restraints only and do not deploy in all crash circumstances. Always use safety belts and seat children in the rear, using restraint systems appropriate for their size and age.

+ FEATURE NOT SHOWN



## S4 Packages

1



2



1



3



## S4 Packages

**1. Audi Drive Select Package** | Audi drive select controls the vehicle's adaptive suspension, dynamic steering, transmission shift characteristics and engine response. The system offers your Audi four distinct driver configurations: Comfort, Auto, Dynamic and Individual. On the S4, the package also includes quattro® with Sport Rear Differential, which dynamically varies torque between the rear wheels to reduce understeer and enhance agility. [Prestige only]

**2. Audi MMI® Navigation plus Package** | The Audi MMI® Navigation plus Package features a 7" full-color LCD screen and MMI control logic. The S4 comes equipped with the latest generation of MMI, powered by a 40-GB hard drive and an NVIDIA® processor to enhance graphics. This generation MMI offers a color driver information system, real-time traffic and voice control for navigation and telephone functions. Additionally, it offers 3D topography graphics that include the buildings in many cities and the crystal clear digital AM and FM sound of HD Radio™ Technology with over 1,000 new stations. Also included is the Audi parking system with a rearview camera for real-time viewing of the parking area with rear ultrasonic parking sensors measuring the distance to the nearest object and audibly warning you when the distance becomes unsafe. [Premium Plus only]

**3. Titanium Sport Package** | Inspired by the Audi motorsport legacy, this package includes a number of aesthetic and performance enhancements. Exterior elements include black window trim, titanium-finish wheels and the iconic black Singleframe® grille.

7

8



## S4 Packages

1



2



3



1



## A4 S4 Accessories

**4 18" Candelas wheels** | These wheels make a strong statement with an eye-catching design. All of our alloy wheels are specially engineered to meet the strict tolerances of our Audi original wheels.

**5 18" Cascara wheels** | A new-look rotor design means these alloy wheels stand out from the crowd.

**6 Rear spoiler** | A trunk lip spoiler adds a sporty flair to your A4 sedan.

**7 Front spoiler with blade insert** | This Audi-designed styling component creates a dynamic lowered appearance with a front spoiler and blade. [A4 only]

**8 Distinctive side sills** | Completes the look of your A4 sedan or Avant.

**9 Rear diffuser with blade insert** | This Audi-designed styling component adds an aggressive edge to your A4. [A4 only]

**10 Polished stainless steel exhaust tips** | Enhance the look of your A4 sedan or Avant with these tailpipe embellishers. Made of highly polished stainless steel. Tips feature rolled edges and are angle cut. [A4 only]

**11 Canoe and kayak rack** | This rack enables you to carry one canoe or kayak weighing up to 55 lbs. Rack conforms to most hulls. Includes one pair of heavy-duty straps. [Must be used in combination with the base carrier bars, which are sold separately]

**12 Premium all-weather floor mats** | These trim-profile, embossed rubber mats help extend the life of your carpet. Available in black, in sets of two for front and/or rear.

**13 19" Cortada wheels** | These alloy wheels feature the latest hollow-spoke technology for a lower-weight wheel that delivers improved driving dynamics and comfort.

**14 Ski and snowboard racks** | These racks' rubber-cushioned aluminum bars hold securely. Our smaller standard attachment holds up to two snowboards or four skis. A larger deluxe attachment holds up to four snowboards or six skis. [Must be used in combination with the base carrier bars, which are sold separately]

**15 Premium textile floor mats** | These precision-fit mats are made of long-life fabric to help protect the interior of your Audi from the elements. Skid-resistant. Available in black. Set of four mats.

**16 Splash guards** | Help protect your Audi vehicle's finish with custom-fit front and rear splash guards. Made of long-life, crack-resistant rubber. Available in sets of two for front and/or rear. [A4 only]

+ FEATURE NOT SHOWN



A4 Wheels

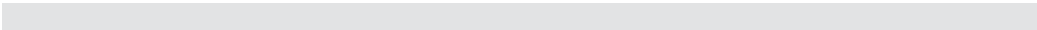

## A4 Wheels

1. **17" seven-spoke wheels with 225/50 all-season tires** | The seven-spoke wheel is a refined design that complements the sport-inspired style of the A4. The wheels come equipped with all-season tires, offering year-round performance and comfort. [Premium only]
2. **17" ten-spoke wheels with 245/45 all-season tires** | The motorsport-inspired 17" wheels offer a visual complement to the overall vehicle design. Additionally, year-round performance is enhanced with all-season tires, helping to ensure a safe and comfortable ride on virtually all surfaces. [Premium Plus only]
3. **18" five-spoke wheels with 245/40 all-season tires** | The refined simplicity of the five-spoke wheel complements the graceful lines of the vehicle. Paired with all-season tires, they help ensure a safe and comfortable ride on virtually all surfaces. [Standard on A4 Prestige, optional on Premium Plus]
4. **18" ten-spoke wheels from quattro® GmbH with 245/40 summer performance tires\*** | The 18" quattro® GmbH design is inspired by time at the track. The dynamic approach continues with summer performance tires, improving handling and driving dynamics. [18" Sport Package required. Premium and Premium Plus only]
5. **19" seven-twin-spoke wheels from quattro GmbH with 255/35 summer performance tires\*** | The quattro GmbH 19" wheels with summer performance tires take their inspiration from the track. The sport-inspired, quattro design complements the exterior of the A4. [S line® Package or 19" Sport Package required. Prestige only]
6. **Titanium Sport Package wheels with 255/35 summer performance tires\*** | The titanium color five-spoke wheel is complemented by the summer performance tires that offer enhanced handling. [Titanium Sport Package required]

\* Summer performance tires are designed for optimum performance and handling in warm climates. They are not suitable for cold, snowy or icy weather conditions. If you drive under those circumstances, you should equip your vehicle with all-season or winter tires, which offer better traction under those conditions. We suggest you use the recommended winter or all-season tires specified for your car or their equivalent. These summer performance tires also have a lower aspect ratio that aids performance and handling. However, in order to avoid tire, rim or vehicle damage, it is important that the inflation pressure is regularly checked and maintained at recommended levels. Serious wheel and tire damage may occur if the vehicle is operated on rough or damaged road surfaces, or upon encountering road debris or obstacles. Please also remember in making your selection that, while these tires deliver responsive handling, they may ride less comfortably and make more noise than other choices. Finally, these tires may wear more quickly than other choices. For more information on all of these topics, please consult the owner's manual, your local dealer or call 1-800-FOR-AUDI.

## S4 Wheels



## A4 Wheels

1



2



3



## S4 Wheels

**7. 18" five-parallel-spoke S design wheels with 245/40 summer performance tires\*** | The motorsport-inspired 18" wheels offer a distinctive look, while the summer performance tires help to improve handling and driving dynamics. [Premium Plus only]

**8. 19" five-tri-spoke wheels with 255/35 summer performance tires\*** | The aggressive look of the 19" wheels is complemented by the summer performance tires that offer enhanced handling. [Standard on Prestige, optional on Premium Plus]

**9. Titanium Sport Package wheels with 255/35 summer performance tires\*** | The titanium color five-spoke wheel is complemented by the summer performance tires that offer enhanced handling. [Titanium Sport Package required]

\* Summer performance tires are designed for optimum performance and handling in warm climates. They are not suitable for cold, snowy or icy weather conditions. If you drive under those circumstances, you should equip your vehicle with all-season or winter tires, which offer better traction under those conditions. We suggest you use the recommended winter or all-season tires specified for your car or their equivalent. These summer performance tires also have a lower aspect ratio that aids performance and handling. However, in order to avoid tire, rim or vehicle damage, it is important that the inflation pressure is regularly checked and maintained at recommended levels. Serious wheel and tire damage may occur if the vehicle is operated on rough or damaged road surfaces, or upon encountering road debris or obstacles. Please also remember in making your selection that, while these tires deliver responsive handling, they may ride less comfortably and make more noise than other choices. Finally, these tires may wear more quickly than other choices. For more information on all of these topics, please consult the owner's manual, your local dealer or call 1-800-FOR-AUDI.

7



8



9



# A4 Interior Seating | Decorative Inlay

BLACK LEATHER | ALUMINUM HOLOGRAM INLAY



## DECORATIVE INLAY OPTIONS

- ALUMINUM HOLOGRAM INLAY  
*[Standard]*
- DARK BROWN WALNUT WOOD INLAY  
*[Option]*
- NUTMEG LAUREL WOOD INLAY  
*[Option]*
- PIANO BLACK INLAY  
*[Titanium Sport Package only]*
- BRUSHED ALUMINUM INLAY  
*[S line® only]*

LIGHT GRAY LEATHER | DARK BROWN WALNUT WOOD INLAY\*



\* Optional inlay shown

CARDAMOM BEIGE LEATHER | NUTMEG LAUREL WOOD INLAY\*



BLACK LEATHER/PERFORATED ALCANTARA\* | BRUSHED ALUMINUM INLAY\* [S line® only]



BLACK LEATHER | PIANO BLACK INLAY\* [Titanium Sport Package only]



# S4 Interior Seating | Decorative Inlay

BLACK LEATHER/SILVER ALCANTARA\* | BRUSHED ALUMINUM INLAY



## DECORATIVE INLAY OPTIONS



BLACK LEATHER/ALCANTARA | CARBON FIBER INLAY\*\*



\* Silk Nappa leather is optional on S4  
\* Optional inlay shown  
\* Includes Piano Black inlay on center console

BLACK SILK NAPPA LEATHER\* | BRUSHED ALUMINUM INLAY



BLACK/TUSCAN BROWN SILK NAPPA LEATHER\* | GRAY BIRCH WOOD INLAY\*



BLACK/MAGMA RED SILK NAPPA LEATHER\* | STAINLESS STEEL INLAY\*\*



BLACK/PEARL SILVER SILK NAPPA LEATHER\* | CARBON FIBER INLAY\*\*



A4 S4 Make yours.



A4 Monza Silver\* PEARL EFFECT†



A4 Misano Red\* PEARL EFFECT†



A4 Dakar Beige METALLIC\*



A4 Teak Brown PEARL EFFECT†

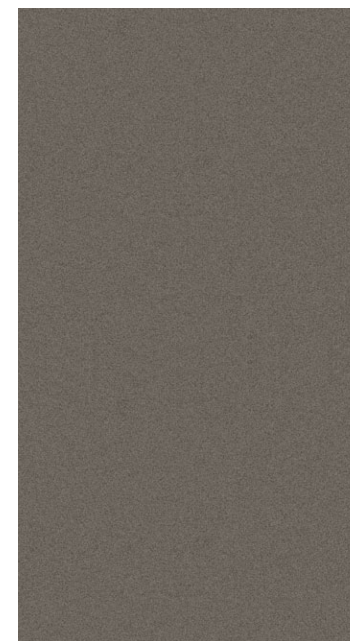
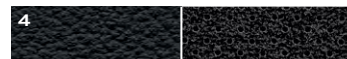
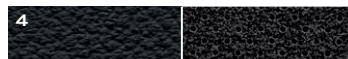

- 1 | Black
- 2 | Light Gray
- 3 | Cardamom Beige
- 4 | Black/Perforated Alcantara\* [S line\* only]
- 5 | Black/Silver Alcantara\* [S4 only]
- 6 | Black/Black Alcantara\* [S4 only]
- 7 | Black/Red [S4 only]
- 8 | Black/Brown [S4 only]
- 9 | Black/Silver [S4 only]

\* S line only  
† Additional charge



A4 S4 Ibis White



A4 S4 Quartz Gray METALLIC\*



A4 S4 Brilliant Black



A4 S4 Ice Silver METALLIC\*



A4 S4 Brilliant Red

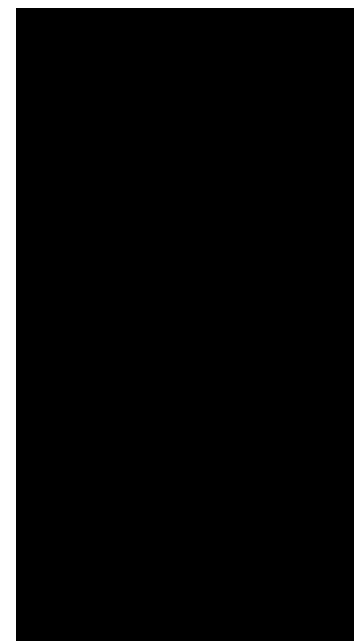
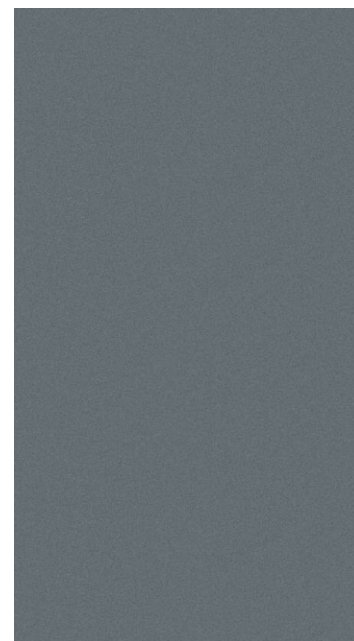
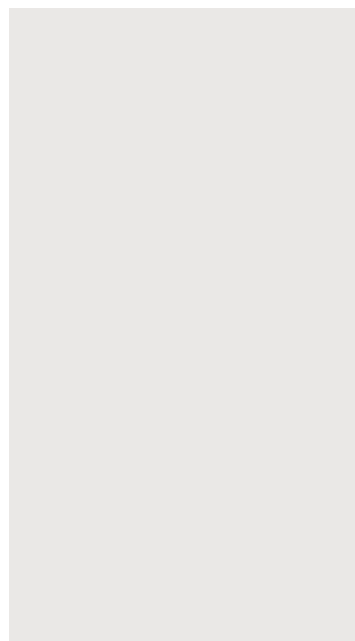



A4 S4 Meteor Gray PEARL EFFECT\*



A4 S4 Phantom Black PEARL EFFECT\*



A4 S4 Deep Sea Blue PEARL EFFECT\*



S4 Sprint Blue PEARL EFFECT\*



S4 Imola Yellow PEARL EFFECT\*

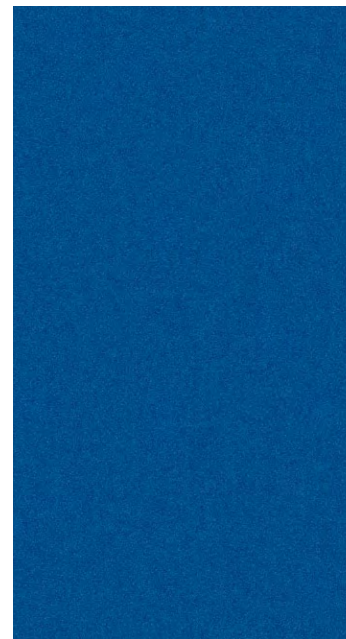
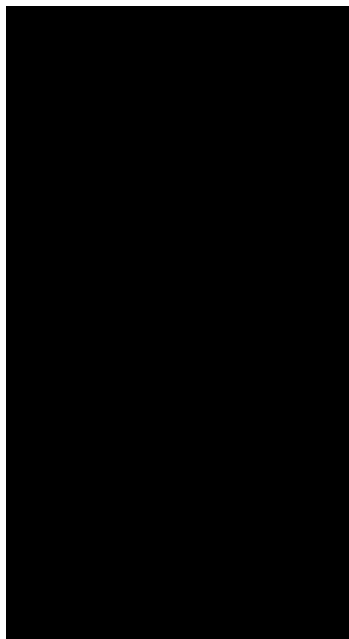
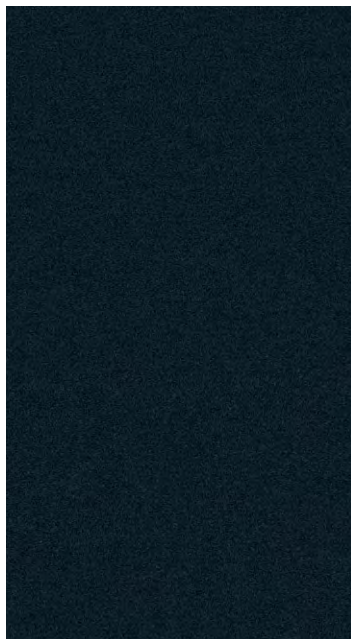

## A4 S4 Specifications | Configurations

Chassis   Technical	A4	S4
Five-link front suspension with upper and lower control arms, stabilizer bar and individual, gas-charged coil springs/shock absorbers	S	S
Independent trapezoidal-link rear suspension with rigid subframe, stabilizer bar and individual, gas-charged coil springs/shock absorbers	S	S
Servotronic® speed-sensitive power steering - varies assistance based on vehicle speed	S	S
quattro® permanent all-wheel drive system utilizing torque-sensing center differential – 40:60 rear-biased torque split	0	S
quattro with Sport Rear Differential permanent all-wheel drive system utilizing torque-sensing center differential – 40:60 rear-biased torque split and variable torque application between rear wheels	-	0
Sport suspension calibration	0	-
S4 sport suspension calibration	-	S
Multitronic® continuously variable transmission (CVT)	S	-
Six-speed manual transmission	0	S
Eight-speed Tiptronic® automatic transmission	0	-
Seven-speed, S tronic® dual-clutch automatic transmission	-	0
Fully galvanized steel unibody with multistep anti-corrosion protection	S	S
Safety   Security	A4	S4
Driver and front passenger advanced dual-stage airbag* supplemental restraints	S	S
Driver and front passenger seat-mounted side thorax airbag* supplemental restraints	S	S
Sideguard® head curtain airbags* for both rows of seats	S	S
Front passenger occupant detection for airbag* supplemental restraints	S	S
Front three-point safety belts with automatic pre-tension and force limiters; height adjustable for front seating positions	S	S
Rear three-point safety belts with belt force limiters for outboard passenger seating positions	S	S
Safety belt reminder for driver and front passenger	S	S
Lower Anchors and Tethers for CHildren (LATCH) in rear seats	S	S
Pinch protection for passenger compartment windows	S	S
Central locking system with selective unlock feature	S	S
Impact protection – including reinforced high-strength steel/aluminum cross members, reinforced bumpers and rigid occupant cell	S	S
Tire pressure monitoring system	S	S
Electronic Stabilization Program (ESP®)	S	S
Anti-lock Brake System (ABS) with Electronic Brake-pressure Distribution (EBD)	S	S
Brake assist – a system that automatically senses emergency braking and applies maximum power boost to reduce overall stopping distance	S	S
Electromechanical parking brake	S	S
Reflectors in rear of all doors	S	S
Anti-theft vehicle alarm system with blinking theft-deterrent light	S	S

Interior	A4	S4			
Four-spoke, multifunction, leather-wrapped steering wheel with controls for audio volume, Bluetooth* phone and audio seek functions	S	-			
Three-spoke, sport, multifunction, leather-wrapped steering wheel with controls for audio volume, Bluetooth* phone and audio seek functions	O	S			
Shift paddles on steering wheel	O	S			
Backlit instrument cluster with brightness control	S	S			
Interior lights in overhead console with front map lights	S	S			
Red ambient LED lighting in headliner for front center console illumination	S	S			
Tilt and telescopic manually adjustable steering column	S	S			
Folding front center armrest with adjustable height	S	S			
Storage nets in backs of front seats	S	S			
Dual front sun visors with lighted vanity mirror for driver and front passenger	S	S			
Interior trunk release on driver's door	S	S			
Leather seating surfaces	S	-			
Leather seats with Alcantara® inserts	O	S			
Silk Nappa leather upholstery	-	O			
Eight-way power driver seat with four-way power lumbar adjustment	S	-			
Eight-way power passenger seat	S	-			
Eight-way power sport front seats with four-way power lumbar adjustment	O	-			
Eight-way power S4 sport seats with integrated head restraints and four-way power lumbar adjustment	-	S			
Memory for driver seat adjustment and exterior mirrors	O	O			
Six-step heated front seats	O	S			
Split folding 60/40 rear seatback	O	S			
Glass sunroof with sliding and tilting functions	S	S			
Automatic climate control	S	-			
Three-zone automatic climate control	O	S			
Electric rear window defogger with automatic timed shut-off feature	S	S			
Power windows with one-touch up/down operation and pinch protection	S	S			
-	Not Available	O	Option	S	Standard

The table above represents the standard equipment on the A4 Premium model and S4 Premium Plus model. Many popular options are combined and available on the A4 Premium Plus and Prestige models. Please see the package contents in this brochure for complete details.

\* Airbags are supplemental restraints only and will not deploy under all crash circumstances. Always use safety belts and seat children in the rear, using restraint systems appropriate for their size and age.

† Your Audi vehicle is equipped with a phone preparation utilizing Bluetooth interface to enable hands-free functionality [compatible mobile phones sold separately]. You will need a Bluetooth-enabled mobile phone in order to utilize this function. Not all Bluetooth-enabled mobile phone models are compatible with Audi phone preparation. Visit [audiusa.com/bluetooth](http://audiusa.com/bluetooth) or contact your local Audi dealer for the latest listing of compatible phones. Audi recommends use of the Audi phone cradle [sold separately] with your mobile phone while operating this vehicle.

‡ Audi Navigation plus depends on signals from the worldwide Global Positioning Satellite network. The vehicle's electrical system, and existing wireless and satellite technologies, must be available and operating properly for the system to function. The system is designed to provide you with suggested routes in locating addresses, destination and other points of interest. Changes in street names, construction zones, traffic flow, points of interest and other road system changes are beyond the control of Audi of America, Inc. Complete detailed mapping of lanes, roads, streets, toll roads, highways, etc., is not possible; therefore, you may encounter discrepancies between the mapping and your actual location. Please rely on your individual judgement in determining whether or not to follow a suggested Audi Navigation plus route. Periodically, the mapping is updated, and a new DVD will be required in order to maintain the latest navigation information available to us. These will be available for purchase from time to time at an additional cost. Consult your dealer or call 1-800-FOR-AUDI for details.

Infotainment   Technology	A4	S4
Audi concert system with single CD player with MP3 playback capability, AM/FM radio, auxiliary input jack, SD card slot for MP3 files and speed-dependent volume control	S	S
SIRIUS® Satellite Radio with three-month trial subscription	S	S
HD Radio™ Technology	O	O
Audi Sound System, 180 watts with ten speakers, including a subwoofer and center fill speaker	S	S
Bang & Olufsen® Sound System – 505 watt audio system with 14 speakers and ten-channel amplifier	O	O
Audi Navigation plus¹ with 3rd generation MMI® operating system, hard-drive navigation, one DVD player, HD radio, two SD card slots for MP3 files, and SIRIUS® Satellite Radio	O	O
Audi music interface with iPod® integration	O	S
Voice control for navigation, directory and telephone	O	O
Bluetooth¹ preparation for mobile phone	O	S
HomeLink® universal remote control	O	S
Driver information system – trip computer, outside temperature, radio/telephone/navigation display, Auto-Check, open door/deck lid indicator	O	S
Electronic cruise control	S	S
Adaptive cruise control – maintains preset distance from vehicle in front	O	O
Automatic light switch controlled by light sensor, “coming home” and “leaving home” functions	O	S
Rain sensor for automatic windshield wipers	O	S
Power central locking system with radio-operated key fob remote control for doors, deck lid and fuel door	S	S
Audi advanced key – keyless start, stop and entry	O	O

Exterior	A4	S4
Singleframe® grille with choice of front license plate holder or filler panel with two chrome strips	S	S
LED turn signals in mirror housings	S	S
Chrome trim around exterior windows	O	S
Dual exhaust pipes, positioned left	S	-
S quad exhaust pipes, two left and two right	-	S
Halogen headlights with integrated high and low beams	S	-
Audi xenon plus headlights with automatic self-leveling and integrated LED daytime running lights	O	S
LED taillights [not available on A4 Avant]	O	S
Two front fog lights located in lower front bumper	S	S
Heated windshield wiper nozzles	S	S
Power-adjustable heated side mirrors	S	S
Power-adjustable, auto-dimming and heated exterior mirrors with memory function [body color on A4; Aluminum Optic on S4]	O	O

## A4 Model Configurations

- 2.0 TFSI® with Multitronic® CVT and FrontTrak® front-wheel drive
- 2.0 TFSI with six-speed manual transmission and quattro® all-wheel drive
- 2.0 TFSI with eight-speed Tiptronic® transmission and quattro all-wheel drive

### Power and Performance

2.0 liter turbocharged with intercooler, DOHC in-line four-cylinder gasoline engine with FSI® direct injection, variable valve timing and Audi valvelift system

- + Horsepower: 211hp @ 4300-6000 RPM
- Torque: 258 lb-ft. @ 1500-4200 RPM
- + 0-60 MPH in seconds – Multitronic: 7.1, Manual: 6.4, Tiptronic: 6.6
- Top track speed\*: 130 MPH
- + Fuel economy estimates, city/highway†: Multitronic: 23/30 MPG; Manual: 22/30 MPG; Tiptronic: 21/27 MPG‡

## S4 Model Configurations

- 3.0 TFSI with six-speed manual transmission and quattro all-wheel drive
- 3.0 TFSI with seven-speed dual-clutch S tronic® transmission and quattro all-wheel drive

### Power and Performance

3.0 liter supercharged, DOHC V6 gasoline engine with dual intercoolers, FSI direct injection and variable valve timing

- + Horsepower: 333hp @ 5500-7000 RPM
- Torque: 325 lb-ft. @ 2900-5300 RPM
- + 0-60 MPH in seconds: 4.9
- Top track speed§: 155 MPH
- + Fuel economy estimate, city/highway†: Manual: 18/27 MPG; S tronic: 18/28 MPG

## A4 S4 Dimensions

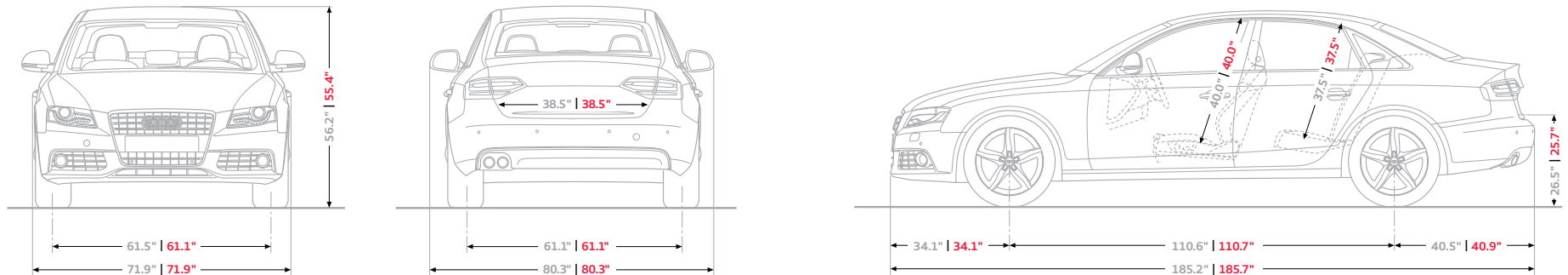

\* Top track speed for A4 electronically limited to 130 MPH in the U.S. Obey all local speed and traffic laws. † EPA fuel economy estimates. Your mileage may vary. ‡ Based on 2010 EPA estimates. § Top track speed for S4 electronically limited to 155 MPH in the U.S. Obey all local speed and traffic laws.

2011 | A4 S4

Audi of America

Audiusa.com

Facebook.com/Audi

BR-A4-10-1300US

Note: A word about this brochure. Audi of America, Inc. believes the specifications in this brochure to be correct at the time of printing. However, specifications, standard equipment, options, and colors are subject to change without notice. Some equipment may be unavailable when your vehicle is built. Please ask your dealer for advice concerning current availability of standard and optional equipment, and your dealer will verify that your vehicle will include the equipment you ordered. Vehicles in this brochure are shown with optional equipment. See your dealer for complete details on the new-vehicle limited warranty, twelve-year limited warranty against corrosion perforation, and Audi 24/7 Roadside Assistance. [Roadside assistance coverage provided by Road America in the U.S. Certain conditions apply; see your dealer for details.] Tires supplied by various manufacturers. "Truth in Engineering" is a registered trademark of Audi of America, Inc. "Audi," "quattro," all model names, "Multitronic," "FrontTrak," "MMI," "FSI," "Singleframe," the Singleframe grille design, and the four rings logo are registered trademarks of Audi AG. "Servotronic" is a registered trademark of the AM General Corporation. "Tiptronic" is a registered trademark of Dr. Ing h.c. F. Porsche AG. "Alcantara" is a registered trademark of Alcantara S.P.A. "HomeLink" is a registered trademark of Prince Corporation, Holland, Michigan. "SIRIUS" is a registered trademark of SIRIUS Satellite Radio, Inc. "Bluetooth" is a registered trademark of Bluetooth SIG. "iPod" and "iPhone" are registered trademarks of Apple Computer, Inc. HD Radio™ and the HD Radio logo are proprietary trademarks of iBiquity Digital Corporation.

©2010 Audi of America, Inc.