

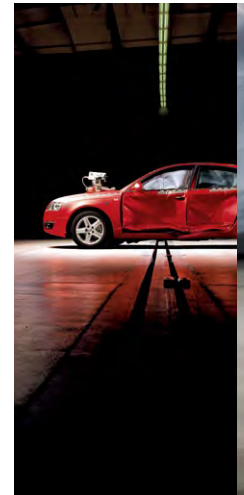

A5 S5

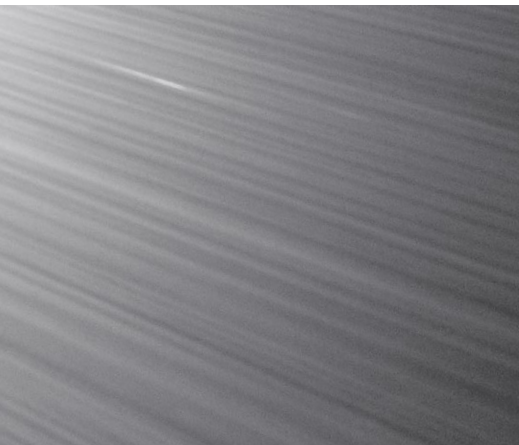

substance always wins the day

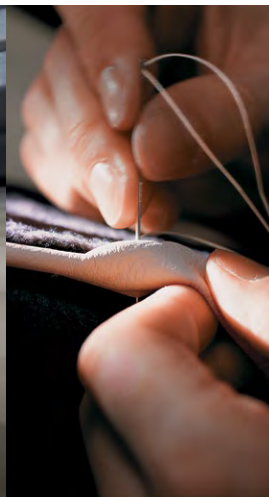

It takes more than hard work, dedication and vision to create the truly exceptional. It takes something intangible. Something you can't quite put your hands on. It's courage, guts, perseverance, passion and fierceness of focus all wrapped into one.

And it's this intangible characteristic that defines all of us at Audi. It's the driving force behind

every pencil line we draw, every calculation we make and every idea we deem not good enough.

It's why every inch and curve and angle has purpose. It's why we test our cars at the highest of speeds for hours on end so they can be driven on any surface and in any condition - rain, shine or white-out blizzard.

It's why substance always wins the day. It's why cutting a corner, even a weld seam in the trunk, would be sacrilegious. And it's why for us scrutiny is so deeply ingrained it's like the very act of breathing.

This is Truth in Engineering. And this is Audi.



A5 Premium Plus

a badge doesn't define you
it represents you



Contents

- ▶ 6-11 The A5 Experience

 - ▶ 14-17 The S5 Experience

 - ▶ 18 quattro®
 - ▶ 20 Performance
 - ▶ 22 MMI®
 - ▶ 24 Safety
 - ▶ 26 Handling

 - ▶ 28 A5 Premium | Premium Plus
 - ▶ 32 A5 Prestige | Packages
 - ▶ 36 A5 Options | S5 Premium Plus
 - ▶ 40 S5 Prestige | Options
 - ▶ 44 S5 Packages | Accessories
 - ▶ 48 Wheels
 - ▶ 52 A5 Interior Colors
 - ▶ 54 S5 Interior Colors
 - ▶ 56 Exterior Colors
 - ▶ 59 Specifications | Configurations
-

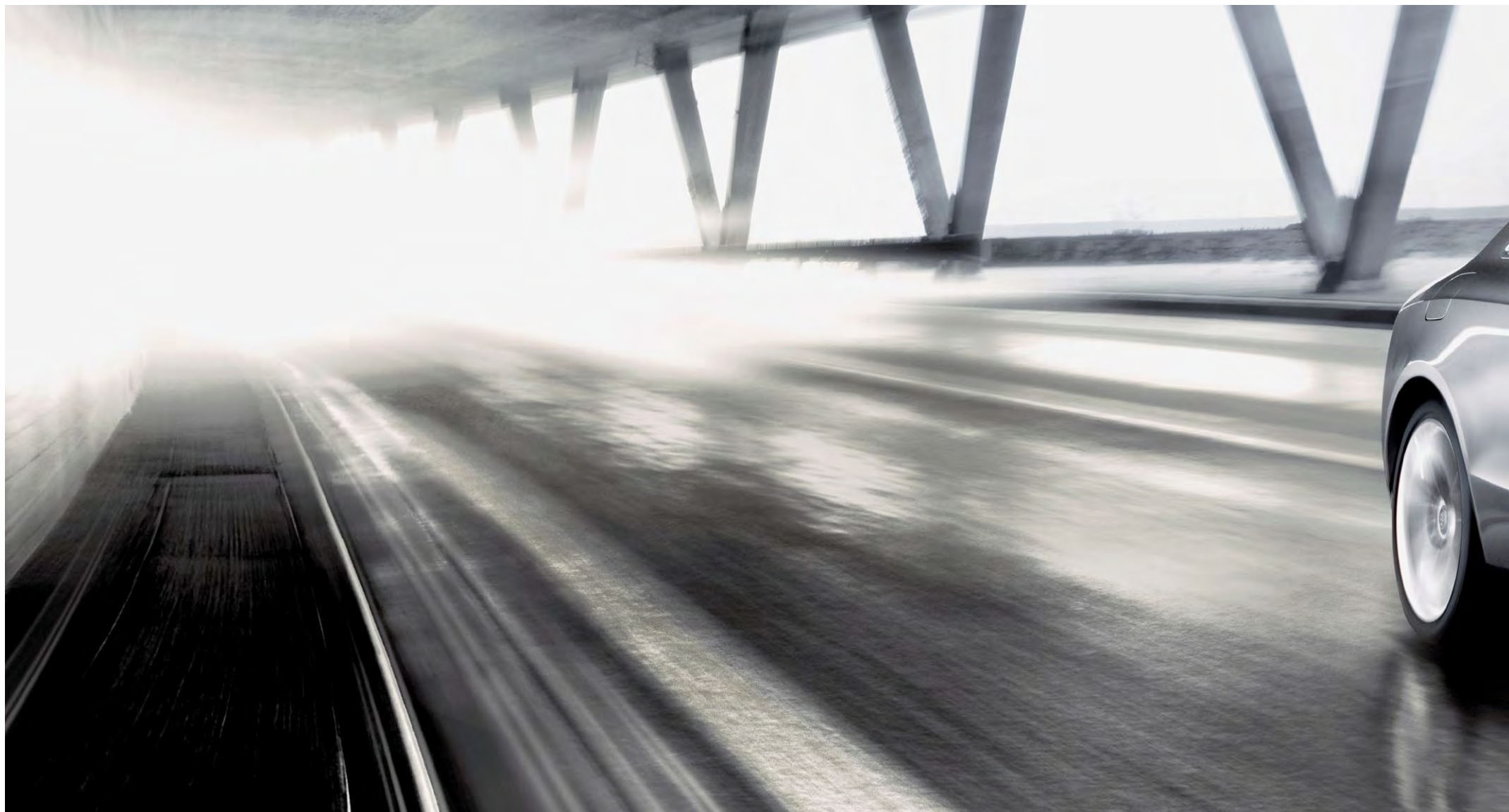

A5

thrilling



A5 Premium Plus

The A5 is sleek and sophisticated, and when compared to others in its class, nothing comes close. Named as the 2009 "Design of the Year" by *AUTOMOBILE Magazine*, the A5 complements your sense of style with its own progressive look.

The refined A5 connotes motion – even when motionless. Designed by Walter de'Silva, the A5 is a progressive coupe in every sense. It's elegance in motion with distinctive performance overtones. It's this combined effect that creates what he calls, "The most beautiful car I've ever designed."

A closer look at the primary design elements of the A5 reveal the signature Audi Singleframe® grille straddled by dramatic LED daytime running lights. The sculpted contours of the body reveal precise lines that define its visual

hallmarks: two feature lines in the shape of a "V" uniting the A5 from the end of the hood to the bumper. Combined with dynamic curves, the body allows for the interplay of light and shadow, giving the A5 a pronounced dynamism.



front and center

The interior of the A5 places you in the middle of thousands of exquisite details, all designed to create a one-of-a-kind driving experience. Premium materials like Dark Brown Walnut wood or Aluminum inlays are honed to a maximum tolerance of just 0.2 mm. The Genuine Milano leather undergoes no less than 45 tests to determine durability and comfort. Even the color of the leather, dash and inlays are precisely matched, compensating for variations in texture and reflectivity. Together, they create an interior unmatched in its class.

Angled slightly toward you, the driver-oriented cockpit with a hand-stitched, leather-wrapped steering wheel is the focal point, where technology and craftsmanship intersect. The stitching, the precise positioning of the spokes for your thumbs and even the thickness of the steering wheel itself create a feeling of total control.







VDT 1909

A5

2.0T





A5 Prestige

carve

The A5 delivers performance that is thoroughly dialed in. An optimal balance of responsive power and agile handling is the formula that creates the incomparable feel of the A5.

The 211hp 2.0 liter turbocharged engine with 258 lb-ft. of torque flows through quattro®, making the A5 the only car in its class to offer standard all-wheel drive. By splitting the torque with a 40:60 rear bias, handling becomes sportscar-like. When conditions require, the system dynamically shifts the torque to the wheels with the most grip. The result is total confidence around any turn and peace of mind in any weather condition.

The ingenious configuration of the front differential, clutch and steering rack, combined with the use of lightweight aluminum suspension components, contributes to an optimal weight distribution in the A5. The result? Responsive steering, impressive agility and well-balanced driving dynamics.

Comfort combined with precise and responsive handling make the A5 a true performance car.





S5

velocity



S5 Premium Plus

Behind the throaty exhaust note is a high-revving aluminum V8, quattro® all-wheel drive with available Sport Rear Differential and a performance-tuned S5 specific suspension that makes the S5 the perfect Gran Turismo.

All 354hp and 325 lb-ft. of torque are channeled through the most sophisticated Audi all-wheel drive system: quattro with available Sport Rear Differential. Together, they launch the S5 from 0-60 MPH in a mere 4.9 seconds and deliver a

top speed of 155 MPH*. This remarkable system enhances cornering agility by dynamically varying torque between the rear wheels. In tandem with the S-tuned suspension, the S5 seemingly defies physics – and the competition.

* Top track speed for S5 electronically limited to 155 MPH in the U.S. Obey all local speed and traffic laws.

attitude

Carrying on the performance heritage, the S5 incorporates subtle features of both past and present Audi legends. The original Coupe quattro® lines are evident in the C pillar, while the R8 influence is seen in the graceful wheel arches and shoulder line. The long hood and short rear deck area are reminiscent of a classic Gran Turismo, updated with the progressive and modern look only found in an Audi. The contemporary appearance of the S5 is carried

through with 19" alloy wheels and the distinctive LED daytime running lights bracketing the Singleframe® grille. Trademark S model elements include S badging on the aluminum doorsills and steering wheel, while the S specific bumpers feature the unique front and rear splitters. Add Aluminum Optic side view mirrors and the quad exhaust that delivers a note of obvious power, and the total package personifies pure performance.



S5 Premium Plus







exacting

Through and through the S5, precision tolerances, tirelessly tested materials and finishes create an interior sought after by drivers who demand absolute perfection. The Silk Nappa leather S-design sport seats with integrated head restraints are a perfect

example. That declaration of perfection is found on the S badge on the steering wheel, doorsills and gauges. Together, it signals you haven't settled for anything less than an exacting performance car.

- 1** S-design leather sport seats feature hand-stitching, an embossed S5 logo, extendable thigh support and supportive side bolsters for cornering comfort and driver control.
- 2** Only specially selected, unblemished leather is worthy of the Silk Nappa leather S-design sport seats.
- 3** The leather-wrapped, three-spoke, multifunction, sport steering wheel with contrast stitching and an S5 badge offers essential infotainment controls at your fingertips.
- 4** Numerous interior color options and unique inlay choices of Brushed Aluminum, Carbon Fiber, Stainless Steel or Gray Birch wood allow you to personalize your S5.
- 5** The 14 speaker Bang & Olufsen® Sound System offers 505 digitally amplified watts of surround sound reproduction and fills the interior of the S5 with crisp, premium sound.

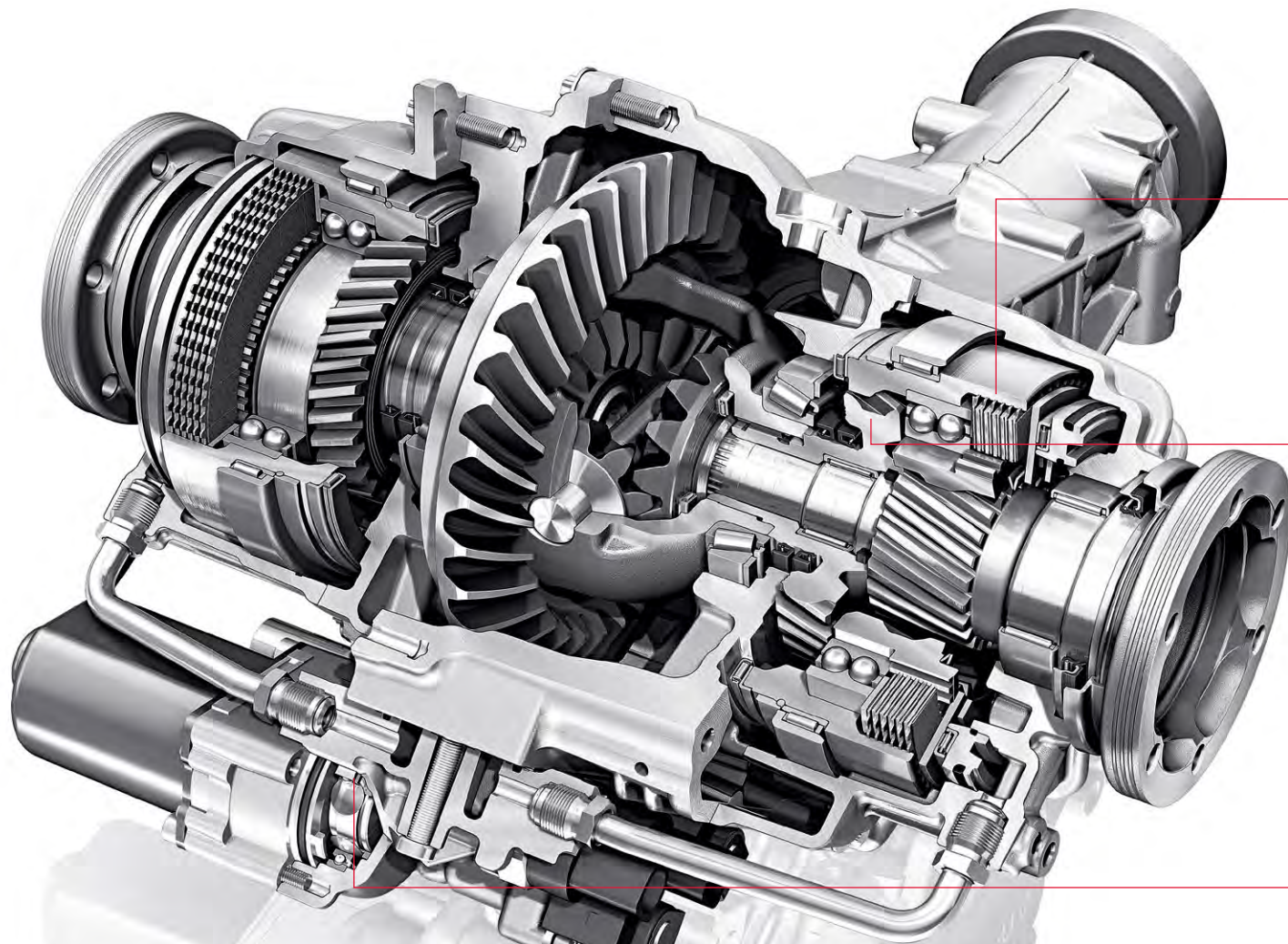

Clutch in Power Flow:

Minimal drag losses
Highest actuation dynamics
Optimal control accuracy

**Overdrive Speed Difference
via Internal Step Gear:**

Compact design
Minimal weight
Optimal efficiency
Instantaneous response

Hydraulic Actuation:

Optimal control
Highest power density

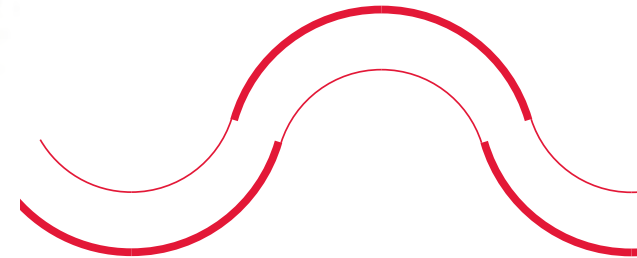

get ready, this is where
it becomes visceral

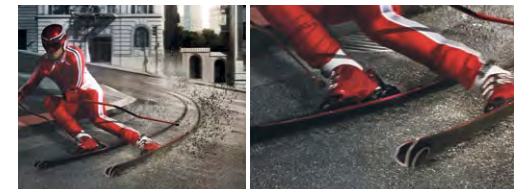

awe

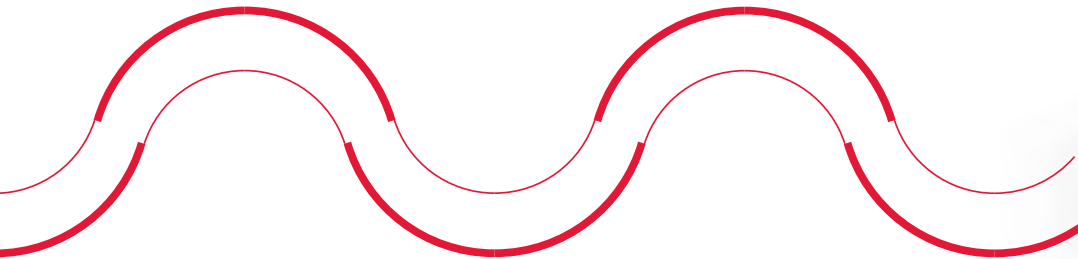

The concept is ingenious, the solution brilliant. Often imitated, nothing drives like quattro®, the world's most innovative all-wheel drive system. It's a technology that we've been developing for 30 years. And the competition? They're just now beginning to realize what we've known for three decades.

For you, quattro means unmatched traction and confidence in less-than-ideal driving conditions and unequal performance all other times.

Permanent all-wheel drive systems are not created equal. And they certainly don't perform that way either. quattro is essentially a mechanical

system devised around a torque-sensing self-locking center differential that shifts torque instantaneously to where it's needed. This means quattro is adjusting power between front and rear axles more than 100 times a second, ensuring torque is delivered to the wheels where traction exists.

In normal driving situations, quattro distributes the power between each axle by sending 40 percent to the front wheels and 60 percent to the rear wheels, enhancing the driving dynamics while maintaining optimum control. Constantly assessing grip, quattro helps ensure the best

possible combination of traction and handling, regardless of the road conditions.

quattro with Sport Rear Differential additionally senses which rear wheel to deliver an optimum level of torque. Specifically, it directs most of the power to the outer rear wheel to help steer the car through the corner. This reduces understeer, common among other all-wheel drive systems, and creates the true sportscar handling found in an Audi. The difference between other all-wheel drive systems and quattro is nothing less than dramatic.

What you experience behind the wheel is confidence-inspiring handling. Curves are relished. Rain and snow are greeted with relative indifference. And every drive is an experience in performance bliss.



performance fueled by unconventional thinking



FSI®

Audi Fuel Stratified Injection, or FSI®, offers the benefits of increased performance and fuel efficiency.* FSI direct injection delivers a precise amount of fuel directly into the engine cylinders, as opposed to the engine intake runners. This advanced process helps ensure a more complete combustion, thereby diminishing waste and increasing power.

Additionally, the specially designed piston heads compress the fuel-air mixture in a spiraling motion, creating the most efficient combustion possible. Making the

most of these technologies allows for greater efficiency in the combustion process.

By combining FSI and forced induction, such as a turbocharger, the 2.0T engine employs a variation of FSI called TFSI®. The principle and benefits are identical. TFSI equipped engines take advantage of significantly higher compression ratios and cylinder pressure, thus fully atomizing fuel and optimizing boost response. The compressor condenses the air flowing into the engine, allowing more air into the cylinder and therefore more power from each ignition.

A forced-induction engine produces greater power than a similar engine without it, significantly improving the engine's power-to-weight ratio. Consequently, Audi is able to use smaller, more efficient engines and achieve similar power and performance results typically found in larger, less-fuel-efficient engines.

The beauty of FSI and TFSI is that they work at any RPM, maximizing efficiency and generating responsive and optimal power during all driving conditions.

Audi Valvelift System

Audi valvelift system helps elevate the performance characteristics of variable valve timing. The result is smooth power buildup, instantaneous throttle response and up to a 7 percent reduction in fuel consumption.

Audi valvelift system intelligently varies the lift and duration of engine exhaust valves in response to engine load and power needs. Optimizing air management, Audi valvelift system helps create maximum torque across a broad range of RPM without sacrificing efficiency.

pulse



4.2 liter FSI® engine with 4163 cc of displacement

Maximum 354hp @ 7000 RPM

Maximum 325 lb-ft. of torque @ 3500 RPM

Specific power output of 84.3hp per liter of displacement

FSI direct injection with up to 120 bar of pressure

A high compression ratio of 11.0:1

0-60 MPH in 4.9 seconds



2.0 TFSI®

The Audi 2.0 liter turbocharged DOHC engine was named one of Ward's "10 Best Engines" for the fifth year in a row as well as "International Engine of the Year" for the fifth time.†

Years ahead of the competition, it combines Audi valvelift system, variable valve timing, TFSI® direct injection and turbocharging for more power and greater efficiency. The 2.0 TFSI was the first engine to combine gasoline direct injection with turbocharging in large-scale production. Producing 211hp and 258 lb-ft. of torque, it has been the engine of choice for more than 1.3 million Audi drivers worldwide.

4.2 FSI®

The Audi 4.2 liter FSI® V8 produces a remarkable 354hp and 325 lb-ft. of torque. Constructed of lightweight aluminum, the 4.2 FSI incorporates many of the same fuel-saving technologies found in the 2.0 TFSI engine, including direct injection and a two-stage intake manifold. The combined effect is an engine that delivers leading power and fuel economy of up to 24 MPG highway.*

The use of the lightweight material not only increases the overall efficiency but also improves handling dynamics.

*EPA estimate: 24 highway MPG. Your mileage will vary.

†Based on 1.8 to 2.0 liter category.

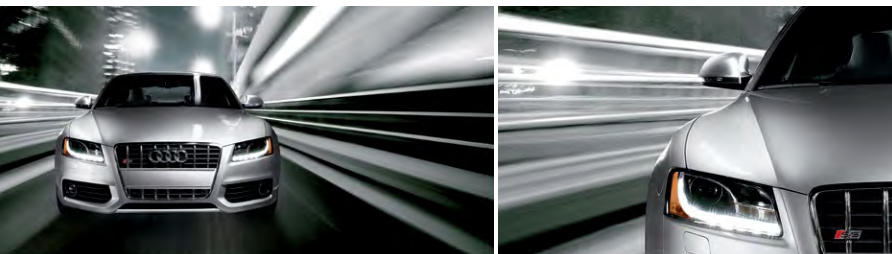

connected

customizing nearly every aspect
of your driving experience

■ Car Setup

The personalization of your vehicle settings can be managed through the MMI® system, enabling you to set your preference for daytime running lights settings, central locking features, the audio system, date and time format, and windshield wiper settings, as well as monitor your service intervals. Individual preferences are all accessed, modified and stored via MMI.

When equipped with Audi drive select, the MMI system enables you to choose your preferred settings for ride comfort and handling.

■ Media

Managing your entertainment options with the MMI system is effortless. With a simple push of a button, MMI allows you to select among the radio tuner, CD/DVD player, AMI or the integrated hard drive. The hard drive allows you to preload 10-GB of personal audio files. Using the control knob, the media source menu and music options are easily viewed on the high-definition MMI screen. Once a selection is made, the track name is displayed.

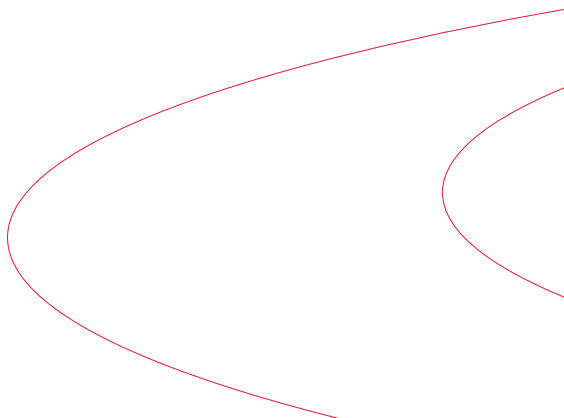

The easy-to-use MMI® (Multi Media Interface) operating system allows you to access various vehicle systems, such as navigation, radio, telephone, voice activation and car setup, to optimize your driving experience. Two major components make the system intuitive.

First, the MMI control knob with integrated joystick, located near the shift lever, allows you to navigate various system functions easily without

diverting your eyes from the road. Secondly, voice control offers an additional method to interface with the MMI system. By simply speaking the desired command, the system recognizes the driver's instructions. In both cases, system inputs, selections and options are displayed on the high-definition MMI screen.

Audi was the first manufacturer to use an automotive-grade NVIDIA® chip in the navigation

system that offers high-quality on-screen graphics. The result is smooth, zoom-in and zoom-out functionality and crisp, 3D graphics of buildings and topography for easier navigation.

At its core, the MMI system has a central media and communications computer that controls the navigation functions, the Bluetooth® universal mobile phone preparation, voice control, and media with integral DVD drive and a 40-GB

hard drive. When equipped with the Audi music interface (AMI), an iPod® and other mobile media players can be accessed via the MMI system for easy music selection.

From music to navigation and more, the MMI system is your pathway to truly personalizing your driving experience.



Radio

In addition to offering analog, HD Radio™ Technology and SIRIUS® Satellite Radio tuning, MMI allows you to tune the receiver by scrolling through your preset radio stations; adjust the audio settings, and customize the listening experience by tailoring the speaker output. You can also preview what's playing on SIRIUS Satellite Radio stations without changing the station you're currently listening to.

Voice Control

Building on the convenience of the MMI system, voice control allows you to operate the main functions, such as telephone and directory, with voice commands. The navigation system is also voice-enabled, allowing for town and street names to be spoken as a navigation destination without having to spell them out letter by letter. The same capability exists for the telephone feature.

Telephone

The MMI system offers integrated Bluetooth technology to support more than one Bluetooth-compatible mobile phone. The system allows the driver or passengers to seamlessly switch among the supported phones and their listings as well as the contacts stored in the MMI system.

3D Navigation

The map displayed on the MMI screen is shown in a three-dimensional topographical format. For added convenience, a large number of cities are displayed in a detailed, three-dimensional format, visually articulating building and road specifics for easier readability.



confidence

we've got your back, front, sides and top



Audi has always held firm the belief that prevention is the best safety feature of all. And the Audi A5 and S5 offer an abundance of features designed to help keep you out of harm's way. For instance, the Electronic Stabilization Program (ESP®) helps keep the vehicle traveling in its intended direction by utilizing ABS, the traction control of ASR and the electronic brake force distribution of EBD.

Audi has implemented a number of ingenious features to help maximize braking effectiveness. In wet conditions, the brake disc wiping system gently pulses the brakes to help dissipate water buildup. Keeping the discs as dry as possible helps promote the most effective braking. Additionally,

the brake assist system is able to detect an attempt at full braking and apply full stopping power when required. The advantage is that braking distance is significantly reduced.

Inside, the Audi safety systems prepare for the worst once the brake assist system is engaged. The safety belt pre-tensioners are activated for all occupants, and lock the safety belts in place. This is intended to help keep passengers in the safest position in the event of a collision.

When prevention isn't enough, the combination of crumple zones and high-strength steel helps deliver a tremendous level of protection for the

driver and passengers. Crumple zones, at the front and rear of the vehicle, are designed to dissipate the energy and force of a collision by deforming upon impact. The high-strength steel used in and around the occupant cell is designed to protect the integrity of the passenger compartment and those within it.

The six standard, second-generation airbags* provide an additional measure of safety. They include front-impact airbags for the driver and passenger and are designed to help protect the head. Seat-mounted, side-impact airbags for the front seat occupants are designed to help protect

the thorax in a collision. And the side-curtain airbags offer front and rear occupants head protection in the event of a side collision or rollover.

Reacting to rear collision forces, the head restraints help cradle the occupant's head in an effort to reduce the likelihood of a whiplash injury.

Everything comes together to reinforce our commitment to all-encompassing safety.



We have 30 years of experience in developing the world's most sophisticated all-wheel drive system. The result is quattro®. It helps maximize traction by automatically adjusting power to each wheel, making the car feel planted – regardless of conditions. Combine ESP and race-bred braking technology, and you'll feel a level of confidence you've never experienced before.

- ▶ quattro helps increase your margin of safety by helping you maintain maximum traction in a variety of weather conditions.
- ▶ ESP helps ensure your vehicle maintains the intended direction of travel by continuously adjusting a number of drivetrain variables.
- ▶ Four-wheel disc brakes with brake disc wiping offer optimal braking in all kinds of weather.

*Airbags are supplemental restraints only and will not deploy in all crash circumstances. Always use safety belts and seat children in the rear, using restraint systems appropriate for their size and age. This is a dramatization and does not depict what will happen in an accident. All bags will not inflate in real world accidents and if multiple bags deploy they will be in various stages of inflating/deflating and will never all be inflated at the same time.

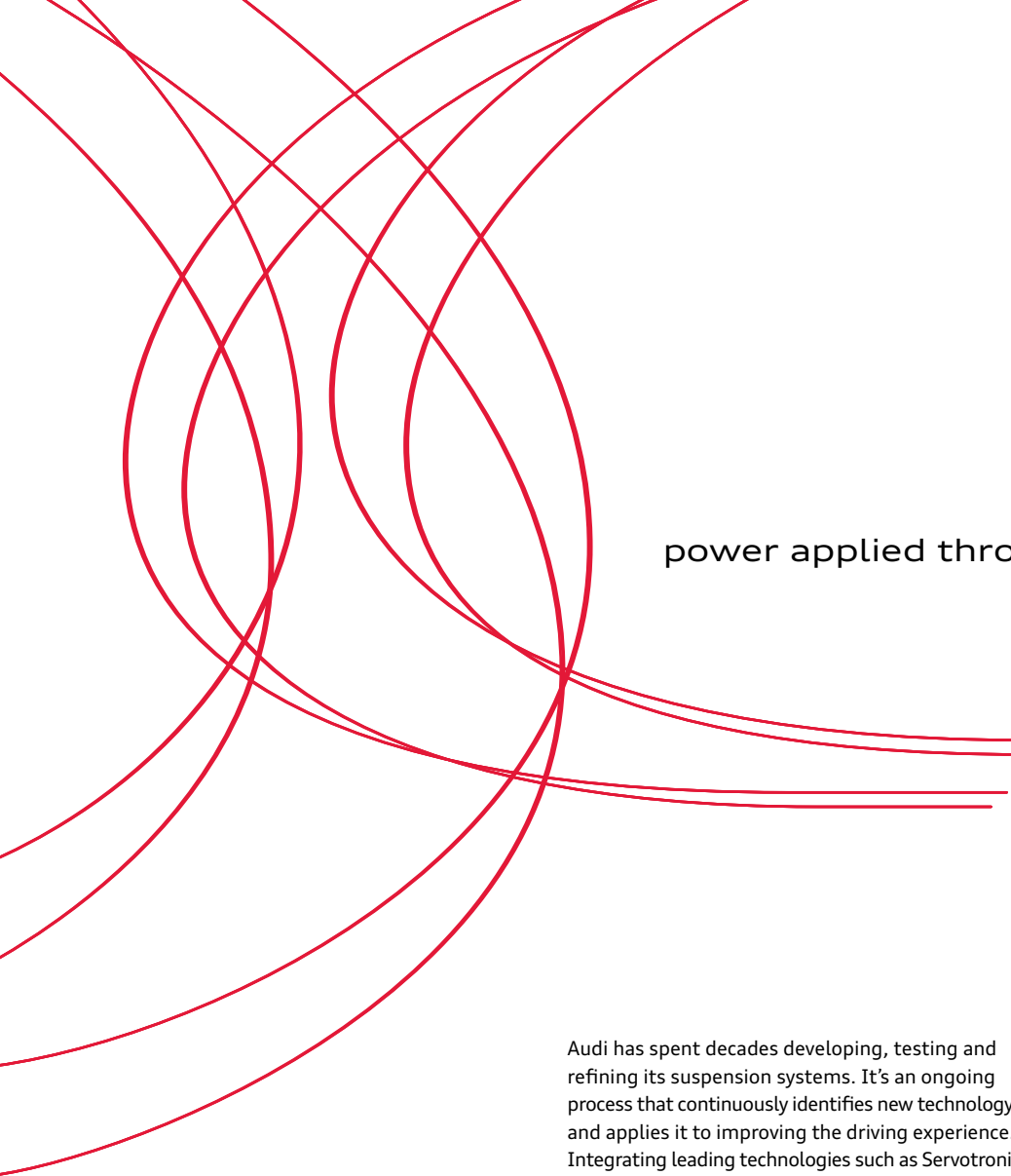

power applied through sophisticated engineering for legendary handling

planted

Audi has spent decades developing, testing and refining its suspension systems. It's an ongoing process that continuously identifies new technology and applies it to improving the driving experience. Integrating leading technologies such as Servotronic® speed-sensitive steering and quattro® all-wheel drive with finely tuned brakes and a rigid chassis result in the refined handling dynamics for which Audi is famous. The suspension system in an Audi consistently delivers precise steering feel, exceptional ride comfort and sharp handling.

■ Five-link Front Suspension

With the finely tuned front-suspension components secured to the subframe, the five-link front suspension increases ride quality by isolating road harshness and vibration from the cabin. The use of weight-saving aluminum for critical components helps reduce unsprung mass at each wheel, allowing the suspension to respond more rapidly. The net effect is a driving experience that is extremely responsive, smooth and predictable. It is handling that has become an Audi hallmark.

■ Rear Suspension

The self-tracking, trapezoidal-link rear suspension provides an incomparable level of driving dynamics. This structure offers a high degree of stiffness that helps ensure precise handling, while the control arm components absorb a great deal of the force encountered by the wheels. The combination helps improve handling response while dampening the abrupt impacts commonly encountered while driving. Additionally, the wheel-guidance components are fixed to the subframe with both rubber and metal bushings to further isolate vibrations from the occupant cell, ensuring a quieter, smoother driving experience.



Dampers and Springs

The linear, high-strength steel springs rest on both the structure of the body and the trapezoidal arms. The two-sleeve gas pressure dampers at all four wheels are tuned for maximum comfort and dynamic handling. This translates to confidence-inspiring handling and control.

Servotronic® Steering

Servotronic® is speed-dependent power steering in which the amount of power assist provided is dictated by road speed, providing even more comfort and convenience for the driver. The amount of power assist is greatest at low speeds, making it easier to maneuver the car. At higher speeds, an electronic-sensing system gradually reduces the level of power assist, creating a tighter, more dynamic steering feel.

To further enhance handling and ride comfort, significant attention to detail has been paid to suppressing vibrations at the attachment points along the steering column. The result is a nearly 100 percent reduction in steering wheel vibration, offering the driver smoothness at virtually any speed.

Audi Drive Select

With 27 available vehicle handling and performance combinations, Audi drive select is another example of Audi progressive technology.

Whether you prefer the smooth, luxurious ride of Comfort mode or the more direct and firmer responses of Dynamic mode, Audi drive select allows you to tailor the vehicle to your liking. Beginning with three preset vehicle configurations, Audi drive select manages the adaptive suspension,

dynamic steering, transmission shift characteristics and throttle response according to the selected mode: Comfort, Automatic or Dynamic.

Adding to the versatility of Audi drive select, the Individual mode manages 27 personalized variations, essentially allowing the driver to configure the vehicle driving dynamics according to his or her precise preferences.

A5 Premium



A5 Premium

1 Leather-wrapped, three-spoke, multifunction steering wheel | The leather-wrapped, three-spoke design has a sporty look and feel. The multifunction steering wheel provides easy access to a Bluetooth®-enabled phone, audio volume and seek functions.

2 Automatic climate control | The climate control system allows the driver and passengers to enjoy an ideal level of heating or cooling via the center console. A light sensor on the dashboard adjusts the system based on the sun's intensity.

3 Leather seating surfaces | The superior quality of leather and impeccable craftsmanship complement the vehicle seat design, enhancing the look and feel of the driving experience.

4 Power-adjustable, heated exterior mirrors with integrated LED turn signals | Powerful and efficient LED turn indicator lamps are artfully incorporated into the sculpted mirror housing, complementing the modern and fluid design of the vehicle. The exterior mirrors are electronically adjustable and heated to help prevent fogging.

5 18" ten-spoke wheels with 245/40 all-season tires | The progressive design of the ten-spoke alloy wheels is matched to the dynamic elegance of the A5. The lightweight alloy wheel complements the excellent driving dynamics.

6 Audi concert radio with ten speakers and SIRIUS® Satellite Radio | This stereo system integrates 180 watts of power, SD card slot, MP3 capability, a CD player and auxiliary input for easy access to a variety of music devices. Aside from exceptional sound quality, the system also features the Radio Data System (RDS), which displays several types of FM radio information as well as the information from the standard SIRIUS® Satellite Radio.

7 Power front seats with driver lumbar support | The power front seats allow the driver and passenger to electronically adjust the seats' forward/backward position, height, angle of seat cushion and seatback, and the driver's lumbar support.

8 Tilting glass panorama sunroof | The sunroof provides passengers with a light-filled driving experience.

Features listed are standard on the Premium model unless otherwise noted.

+ FEATURE NOT SHOWN

A5 Premium Plus



A5 Premium



A5 Premium Plus

5. Three-zone automatic climate control | The driver, front passenger and rear passenger can select and control their desired level of heating or cooling via the center console. A light sensor on the dashboard adjusts the system based on the sun's intensity.

6. LED taillights | LED lights are superior to conventional bulbs, thanks to faster activation speeds and bright light emissions. In addition, they can last an entire vehicle lifetime and consume up to 50 percent less energy while adding a signature look to your Audi.

7. Audi xenon plus headlights with LED daytime running lights | The signature LED daytime running lights and high-intensity headlights not only add a distinct look to the vehicle, they also help improve visibility while using half of the energy of conventional bulbs.

8. Audi music interface | This connective technology offers intelligent integration with the iPod® and iPhone®. Any iPod Generation 4 and higher may be connected through the glove box, providing full iPod controls on the MMI® screen. This feature allows connection of a USB flash drive or a conventional auxiliary audio input as well.

9. Heated front seats | With a convenient touch of a button, the multilevel seat-heating system warms the entire surface of the seat.

10. Auto-dimming interior mirror with compass | The rearview mirror with automatic dimming recognizes glaringly bright beams behind the car and darkens the mirror automatically. An electronic control unit varies the darkening effect quickly and continuously according to actual ambient light conditions. Vehicle direction is displayed through a digital compass in the corner of the mirror.

11. 18" ten-spoke wheels with 245/40 all-season tires | These standout 18" wheels offer sophistication matched with a distinctive ten-spoke style, enhancing the overall exterior of the Audi A5.

12. Bluetooth® mobile phone preparation | The advanced technology of the Audi A5 allows you to conveniently access your Bluetooth®-enabled phone's features via the MMI operating system, allowing for easy, intuitive, hands-free communication. For specific compatibility and operation instructions, refer to audiusa.com/bluetooth or contact your local Audi dealer for the latest listing of compatible phones.

13. HomeLink® | HomeLink® is integrated into the overhead controls and uses a simple three-button system to control garage doors, gates and even lights in your home.

Features listed are standard on the Premium Plus model unless otherwise noted.

+ FEATURE NOT SHOWN



A5 Prestige

1



2



3



¹ **Bang & Olufsen® Sound System** | The 14 speakers and 505 digitally amplified watts with surround sound reproduction fill the interior of the vehicle with crisp, premium sound. Microphone-based noise compensation ensures optimum sound under varying road conditions and speeds.

² **Audi advanced key** | With this advanced keyless entry system, your vehicle can be locked or unlocked and started without removing the key from a pocket or purse. When the key is present, doors can be unlocked, the steering wheel can be released and the vehicle can be turned on without inserting the key into the ignition.

³ **Audi MMI® Navigation plus** | Audi MMI® Navigation plus features a 7" full-color LCD screen and MMI control logic. The A5 comes equipped with the latest generation of MMI, powered by a 40-GB hard drive and an NVIDIA® processor to enhance graphics. This generation MMI offers a color driver information system, real-time traffic, 3D topography graphics that include the buildings in many cities and the crystal clear digital AM and FM sound of HD Radio™ Technology with over 1,000 new stations. Also included is voice control for navigation and telephone functions.

⁴ **Driver memory** | At the touch of a button, your driver seat position and side view mirror positions are set to your desired levels. This feature stores up to two driver settings.

⁵ **Auto-dimming exterior mirrors** | The side exterior mirrors recognize bright lights behind the car and darken the mirror glass automatically.

⁶ **Audi parking system with rearview camera** | When reversing, the rearview camera provides real-time viewing of the rear parking area on the MMI screen, helping you see potentially hazardous objects in parking scenarios. Ultrasonic rear parking sensors measure the distance to the nearest object and audibly warn you when the distance becomes unsafe.

5

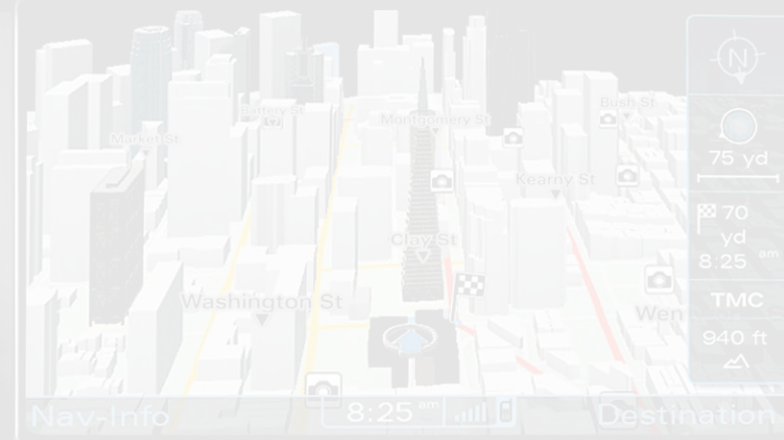

6



Features listed are standard on the Prestige model unless otherwise noted.

+ FEATURE NOT SHOWN

4 S line® Package | The exterior S line® features of the A5 include 19" S line five-Y-spoke wheels with superior handling 255/35 summer performance tires*. Sport suspension is included to help improve driving dynamics. Exterior trim elements include the iconic Singleframe® grille, side valances, S line specific front and rear bumpers, and badging. Inside, elements include Brushed Aluminum doorsills with S line badging and elegant Brushed Aluminum decorative inlays extending across the center console, doors and dashboard. The S line designation extends to the three-spoke, leather-wrapped steering wheel featuring special perforated leather and S line badge. Also included are S line sport seats with leather and perforated Alcantara® seat inserts. [Prestige only]

5 Audi MMI® Navigation plus Package | The Audi MMI® Navigation plus Package features a 7" full-color LCD screen and MMI control logic. The A5 comes equipped with the latest generation of MMI, powered by a 40-GB hard drive and an NVIDIA® processor to enhance graphics. This generation MMI offers a color driver information system, real-time traffic and voice control for navigation and telephone functions. Additionally it offers 3D topography graphics that include the buildings in many cities and the crystal clear digital AM and FM sound of HD Radio™ Technology with over 1,000 new stations. Also included is the Audi parking system with a rearview camera for real-time viewing of the parking area with rear ultrasonic parking sensors measuring the distance to the nearest object and audibly warning you when the distance becomes unsafe. [Premium Plus only]

6 Sport Package | For more performance-oriented handling characteristics, the 19" Sport Package includes a specially tuned, firmer suspension with an assertive stance and sport seats that offer greater lateral support. The 19" sport wheels have a bold, aggressive design and come equipped with summer performance tires*. Tiptronic® models equipped with the Sport Package have shift paddles allowing effortless, race-inspired gear shifting so you can keep your hands on the three-spoke steering wheel. [Premium Plus and Prestige only]

7 Titanium Sport Package | Inspired by the Audi motorsport legacy, this package includes a number of aesthetic and performance enhancements. Exterior elements include black window trim, titanium-finish wheels and the iconic black Singleframe® grille. Inside, the Titanium Sport Package carries the performance look with a Piano Black inlay, black headliner, and supportive sport seats. The enhanced handling performance comes from a specially tuned sport suspension. [Premium Plus and Prestige only]

8 Bluetooth® and HomeLink® Package | The advanced technology of the Audi A5 allows you to conveniently access your Bluetooth®-enabled phone's features via the MMI operating system, allowing for easy, intuitive hands-free communication. For specific compatibility and operation instructions, refer to audiusa.com/bluetooth or contact your local Audi dealer for the latest listing of compatible phones. HomeLink® is integrated into the overhead controls and uses a simple three-button system to control garage doors, gates and even lights in your home. [Premium only]

* See page 49 for important safety information regarding summer performance tires.

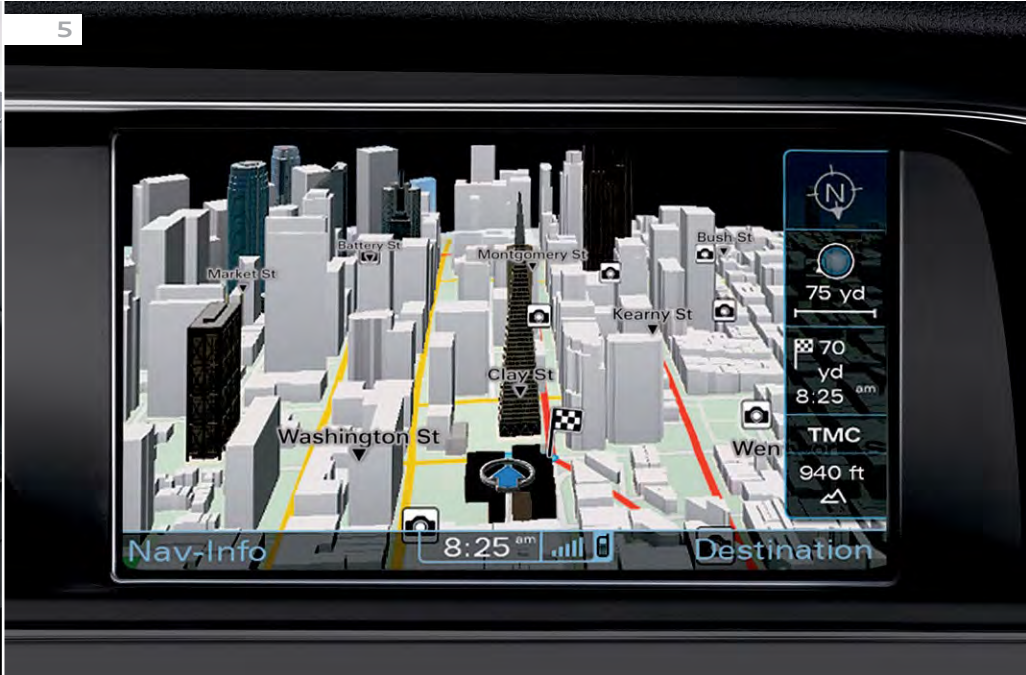

A5 Options

1



2



3



A5 Options

- ¹ **Audi drive select** | Exclusive to Audi, this system provides advanced control of the vehicle's adaptive suspension, dynamic steering, transmission shift characteristics and engine response. The system offers four distinct driving configurations: Comfort, Auto, Dynamic and Individual, where drivers can configure driving characteristics exactly to their liking. [Prestige only]

- ² **Audi side assist** | Active at speeds over 19 MPH, Audi side assist helps monitor blind spots and fast-approaching vehicles at a range of 150 ft. When a vehicle is present within the monitored area, the system warns you via LED lights in the exterior mirrors. [Prestige only]

- ³ **Genuine Milano leather seats** | This special soft leather is luxurious and offers added comfort for both the driver and passengers. [Premium Plus and Prestige only]

- ⁴ **Bang & Olufsen® Sound System** | The 14 speakers and 505 digitally amplified watts with surround sound reproduction fill the interior of the vehicle with crisp, premium sound. Microphone-based noise compensation ensures optimum sound under varying road conditions and speeds. [Premium Plus only]

- ⁴ **Audi music interface** | This connective technology offers intelligent integration with the iPod® and iPhone®. Any iPod Generation 4 and higher may be connected through the glove box, providing full iPod controls on the MMI® screen. This feature allows connection of a USB flash drive or a conventional auxiliary audio input as well. [Premium only]

- ⁴ **Heated front seats** | With a convenient touch of a button, the multilevel seat-heating system warms the entire surface of the seat. [Premium only]

- ⁴ **Audi adaptive cruise control** | This system enhances conventional cruise control by monitoring the distance to the vehicle ahead via radar sensors. The system automatically reduces or resumes speed to help maintain the safe distance selected by the driver. [Prestige only]

- ⁴ **Wood decorative inlays** | The genuine wood decorative inlays in the dash, center console and door panels add a refined touch of luxury to the vehicle's interior. [Available in Dark Brown Walnut or Nutmeg Laurel]

* FEATURE NOT SHOWN

S5 Premium Plus



A5 Options

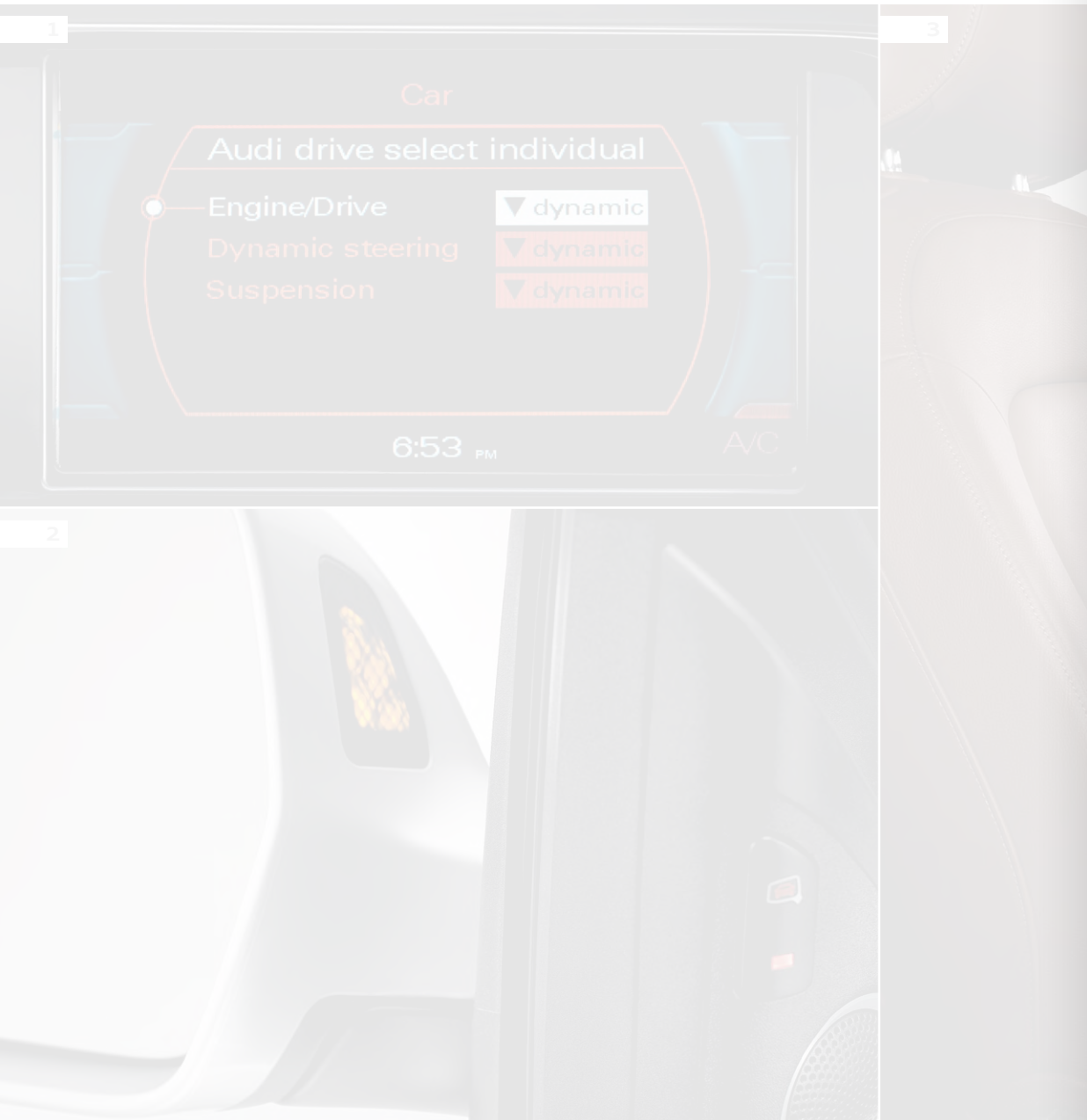

S5 Premium Plus

- 4. **Shift paddles** | Shift paddles allow effortless, race-inspired gear shifting that help keep the driver's hands on the steering wheel. [Tiptronic® automatic transmission only]
- 5. **S5 sport seats** | The sport seats offer greater lateral support thanks to more prominent side bolsters and extendable thigh support. The seat functions include electric lumbar support and integrated head restraints. With standard Silk Nappa leather or available Alcantara® inserts, the S5 sport seats add a distinctive performance-oriented look and feel.
- 6. **19" five-parallel-spoke wheels with 255/35 summer performance tires*** | The track-inspired 19" wheels with summer performance tires offer excellent handling.
- 7. **Dual-exhaust quad tailpipes** | This performance exhaust system features exclusive quad oval tailpipes that create a rich exhaust note and leave no doubt about the power contained under the hood of the S5.
- * **Power-adjustable, heated Aluminum Optic exterior mirrors with integrated LED turn signals** | Powerful and efficient LED turn indicator lamps are artfully incorporated into the sculpted mirror housing, complementing the modern and fluid design of the vehicle. The exterior mirrors are electronically adjustable and heated to help prevent fogging.
- * **Audi music interface** | This connective technology offers intelligent integration with the iPod® and iPhone®. Any iPod Generation 4 and higher may be connected through the glove box, providing full iPod controls on the MMI® screen. This feature allows connection of a USB flash drive or a conventional auxiliary audio input as well.
- * **Bluetooth® mobile phone preparation** | The advanced technology of the Audi S5 allows you to conveniently access your Bluetooth®-enabled phone's features via the MMI operating system, allowing for easy, intuitive, hands-free communication. For specific compatibility and operation instructions, refer to audiusa.com/bluetooth or contact your local Audi dealer for the latest listing of compatible phones.
- * **Audi xenon plus headlights with LED daytime running lights** | The signature LED daytime running lights and high-intensity headlights not only add a distinct look to the vehicle, they also improve visibility while using half of the energy of conventional bulbs.
- * **HomeLink®** | HomeLink® is integrated into the overhead controls and uses a simple three-button system to control garage doors, gates and even lights in your home.
- * **Auto-dimming interior mirror with compass** | The rearview mirror with automatic dimming recognizes glaringly bright beams behind the car and darkens the mirror automatically. An electronic control unit varies the darkening effect quickly and continuously according to actual ambient light conditions. Vehicle direction is displayed through a digital compass in the corner of the mirror.

Features listed are standard on the Premium Plus model unless otherwise noted.

* See page 49 for important safety information regarding summer performance tires.

+ FEATURE NOT SHOWN



S5 Prestige



- 1 **Audi advanced key** | With this advanced keyless entry system, your vehicle can be locked or unlocked and started without removing the key from a pocket or purse. When the key is present, doors can be unlocked, the steering wheel can be released and the vehicle can be turned on without inserting the key into the ignition.

- 2 **Audi MMI® Navigation plus** | Audi MMI® Navigation plus features a 7" full-color LCD screen and MMI control logic. The S5 comes equipped with the latest generation of MMI, powered by a 40-GB hard drive and an NVIDIA® processor to enhance graphics. This generation MMI offers a color driver information system, real-time traffic, 3D topography graphics that include the buildings in many cities and the crystal clear digital AM and FM sound of HD Radio™ Technology with over 1,000 new stations. Also included is voice control for navigation and telephone functions.

- 3 **Bang & Olufsen® Sound System** | The 14 speakers and 505 digitally amplified watts with surround sound reproduction fill the interior of the vehicle with crisp, premium sound. Microphone-based noise compensation ensures optimum sound under varying road conditions and speeds.

- 4 **Auto-dimming exterior mirrors** | The side exterior mirrors recognize bright lights behind the car and darken the mirror glass automatically.

- 5 **Driver memory** | At the touch of a button, your driver seat position and side view mirror positions are set to your desired levels. This feature stores up to two driver settings.

- 6 **Audi parking system with rearview camera** | When reversing, the rearview camera provides real-time viewing of the rear parking area on the MMI screen, helping you see potentially hazardous objects in parking scenarios. Ultrasonic rear parking sensors measure the distance to the nearest object and audibly warns you when the distance becomes unsafe.

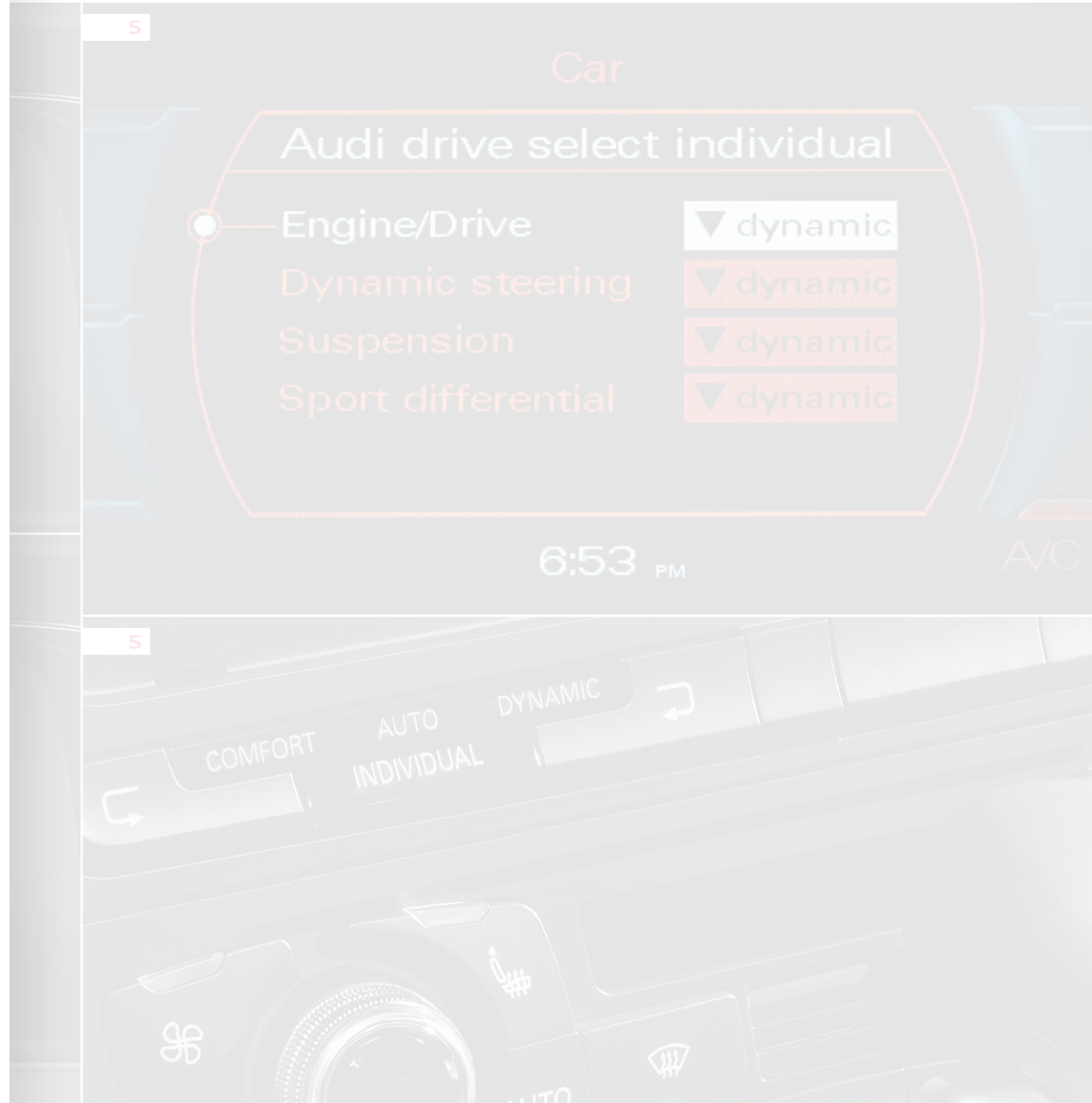

Features listed are standard on the Prestige model unless otherwise noted.

+ FEATURE NOT SHOWN

S5 Prestige

1



2

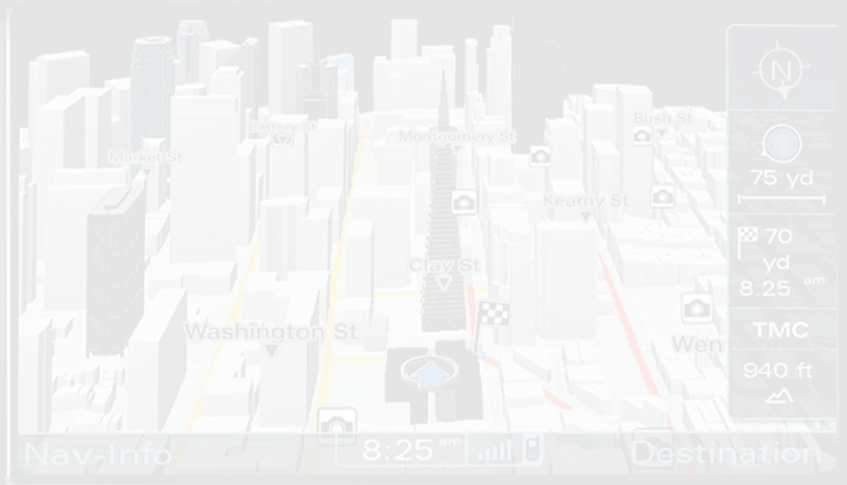

3



S5 Packages

4. Audi MMI® Navigation plus Package | The Audi MMI® Navigation plus Package features a 7" full-color LCD screen and MMI control logic. The S5 comes equipped with the latest generation of MMI, powered by a 40-GB hard drive and an NVIDIA® processor to enhance graphics. This generation MMI offers a color driver information system, real-time traffic and voice control for navigation and telephone functions. Additionally it offers 3D topography graphics that include the buildings in many cities and the crystal clear digital AM and FM sound of HD Radio™ Technology with over 1,000 new stations. Also included is the Audi parking system with a rearview camera for real-time viewing of the parking area with rear ultrasonic parking sensors measuring the distance to the nearest object and audibly warning you when the distance becomes unsafe. [Premium Plus only]

5. Audi Drive Select Package | Audi drive select controls the vehicle's adaptive suspension, dynamic steering, transmission shift characteristics and engine response. The system offers your Audi four distinct driver configurations: Comfort, Auto, Dynamic and Individual. On the S5, the package also includes quattro® with Sport Rear Differential, which dynamically varies torque between the rear wheels. [Prestige only]

*** Titanium Sport Package** | Inspired by the Audi motorsport legacy, this package includes a number of aesthetic and performance enhancements. Exterior elements include black window trim, titanium-finish wheels and the iconic black Singleframe® grille.

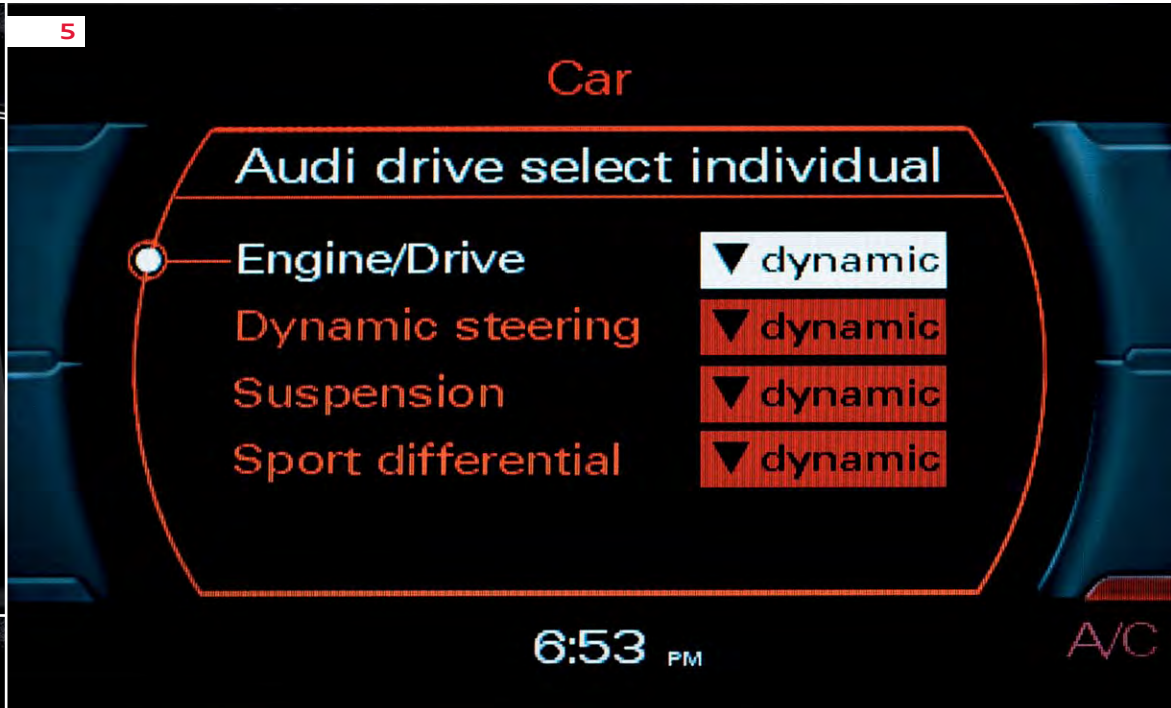

S5 Options



S5 Options

- 1. 19" five-tri-spoke wheels with 255/35 summer performance tires*** | The high-performance look of the 19" wheels is complemented by the summer performance tires that offer enhanced handling.
- 2. Audi adaptive cruise control** | This system enhances conventional cruise control by monitoring the distance to the vehicle ahead via radar sensors. The system automatically reduces or resumes speed to maintain the safe distance selected by the driver. [Prestige only]
- 3. Stainless Steel inlays** | The distinctive Stainless Steel inlays are composed of woven stainless steel threads and are furnished across the dash and doors. The center console is finished with a Piano Black inlay.
- 4. Carbon Fiber decorative inlays** | Exclusive to Audi S models, the sophisticated Carbon Fiber inlay adds a powerful feel to the interior.
- * quattro® with Sport Rear Differential** | Continuing a legacy of all-wheel drive performance, quattro® with Sport Rear Differential dynamically varies torque between the rear wheels for enhanced cornering agility and traction.
- * Bang & Olufsen® Sound System** | The 14 speakers and 505 digitally amplified watts with surround sound reproduction fill the interior of the vehicle with crisp, premium sound. Microphone-based noise compensation ensures optimum sound under varying road conditions and speeds. [Premium Plus only]
- * Audi side assist** | Active at speeds over 19 MPH, Audi side assist helps monitor blind spots and fast-approaching vehicles at a range of 150 ft. When a vehicle is present within the monitored area, the system warns you via LED lights in the exterior mirrors. [Prestige only]

* See page 49 for important safety information regarding summer performance tires.

+ FEATURE NOT SHOWN

A5 S5 Accessories

dressed for performance

Your Audi is just that – yours. With a number of available enhancements, including wheels and a special aerodynamic spoiler, your Audi can become your own signature model.



S5 Options



A5 S5 Accessories

5. Front spoiler with blade insert | An Audi-designed styling component creates a dynamic lowered appearance with a front spoiler and blade. [Available on A5 only]

6. Rear spoiler | A trunk lip spoiler adds a distinctive sporty flair to your A5/S5.

7. 19" Candelas wheel | An impressive, clean, drop-center, deep-dish design makes this 15-spoke wheel the perfect complement to your A5.

8. Side sills | The pronounced side sills reinforce the sporty look of the A5 by giving it a lower, more aggressive look. [Available on A5 only]

*** Rear diffuser with blade insert** | A clean aero-look enhancement for the rear aspect of the A5. [Available on A5 only]

*** Upright Barracuda® bicycle holder** | This bike holder fits 20-80 mm bike frames and is easy to use. It features a molded front wheel well that allows the bike to stand on its own as you easily secure the bike. Lock included. [Must be used in combination with the base carrier bars, which are sold separately]

*** Ski and snowboard rack** | This rack's rubber-cushioned aluminum bars hold securely to the vehicle. Push-button keyed locks open and close easily. Our smaller standard attachment holds up to four skis or two snowboards. A larger deluxe attachment holds up to six skis or four snowboards. [Must be used in combination with the base carrier bars, which are sold separately]

*** Chromed grille strips** | The chromed grille strips accent the distinctive Audi Singleframe® grille. Strips attach to the grille with OEM-grade adhesive for long-lasting durability.



dressed for performance

Your Audi is just that – yours. With a number of available enhancements, including wheels and a special aerodynamic spoiler, your Audi can become your own signature model.



A5 Wheels

1



3



2



4

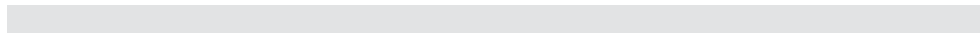

A5 Wheels

¹ **18" ten-spoke wheels with 245/40 all-season tires** | The progressive design of the ten-spoke alloy wheels is matched to the dynamic elegance of the A5 model. The lightweight alloy complements the excellent driving dynamics. [A5 Premium]

² **18" ten-spoke wheels with 245/40 all-season tires** | These standout 18" wheels offer sophistication matched with a distinctive ten-spoke style, enhancing the overall exterior of the Audi A5. [A5 Premium Plus and Prestige]

³ **19" five-Y-spoke wheels with 255/35 summer performance tires*** | A work of art, these wheels make a dramatic and sporty statement, regardless of whether they are moving or motionless. [Optional on A5 Premium Plus and Prestige]

⁴ **19" Titanium Sport Package wheels with 255/35 summer performance tires*** | The titanium color five-spoke wheel is complemented by the summer performance tires that offer enhanced handling. [Titanium Sport Package required]



S5 Wheels



* Summer performance tires are designed for optimum performance and handling in warm climates. They are not suitable for cold, snowy or icy weather conditions. If you drive under those circumstances, you should equip your vehicle with all-season or winter tires, which offer better traction under those conditions. We suggest you use the recommended winter or all-season tires specified for your car or their equivalent. These summer performance tires also have a lower aspect ratio that aids performance and handling. However, in order to avoid tire, rim or vehicle damage, it is important that the inflation pressure is regularly checked and maintained at recommended levels. Serious wheel and tire damage may occur if the vehicle is operated on rough or damaged road surfaces, or upon encountering road debris or obstacles. Please also remember in making your selection that, while these tires deliver responsive handling, they may ride less comfortably and make more noise than other choices. Finally, these tires may wear more quickly than other choices. For more information on all of these topics, please consult the owner's manual, your local dealer or call 1-800-FOR-AUDI.

A5 Wheels

1



3



2



4



S5 Wheels

5. **19" five-parallel-spoke wheels with 255/35 summer performance tires*** | The unique and dramatic profile of these five-parallel-spoke alloy wheels highlights the progressive look of the Audi S5. [S5 Premium Plus and Prestige]

6. **19" five-tri-spoke wheels with 255/35 summer performance tires*** | The boldly distinctive openness of the five-tri-spoke alloy wheels with summer performance tires makes a sporty statement. [Optional on S5 Premium Plus and Prestige]

7. **19" Titanium Sport Package wheels with 255/35 summer performance tires*** | The titanium color five-spoke wheel is complemented by the summer performance tires that offer enhanced handling. [Titanium Sport Package required]

* Summer performance tires are designed for optimum performance and handling in warm climates. They are not suitable for cold, snowy or icy weather conditions. If you drive under those circumstances, you should equip your vehicle with all-season or winter tires, which offer better traction under those conditions. We suggest you use the recommended winter or all-season tires specified for your car or their equivalent. These summer performance tires also have a lower aspect ratio that aids performance and handling. However, in order to avoid tire, rim or vehicle damage, it is important that the inflation pressure is regularly checked and maintained at recommended levels. Serious wheel and tire damage may occur if the vehicle is operated on rough or damaged road surfaces, or upon encountering road debris or obstacles. Please also remember in making your selection that, while these tires deliver responsive handling, they may ride less comfortably and make more noise than other choices. Finally, these tires may wear more quickly than other choices. For more information on all of these topics, please consult the owner's manual, your local dealer or call 1-800-FOR-AUDI.

5



6



7



A5 Interior Seating | Decorative Inlay

BLACK LEATHER OR MILANO LEATHER | ALUMINUM HOLOGRAM INLAY



DECORATIVE INLAY OPTIONS

- ALUMINUM HOLOGRAM INLAY
[Standard]
- DARK BROWN WALNUT WOOD INLAY
[Option]
- NUTMEG LAUREL WOOD INLAY
[Option]
- PIANO BLACK INLAY
[Titanium Sport Package only]
- BRUSHED ALUMINUM INLAY
[S line only]*

LIGHT GRAY LEATHER OR MILANO LEATHER | DARK BROWN WALNUT WOOD INLAY*



* Optional inlay shown

LINEN BEIGE LEATHER OR MILANO LEATHER | NUTMEG LAUREL WOOD INLAY*



BLACK LEATHER OR MILANO LEATHER | PIANO BLACK INLAY [Titanium Sport Package only]



CINNAMON BROWN MILANO LEATHER | NUTMEG LAUREL WOOD INLAY*

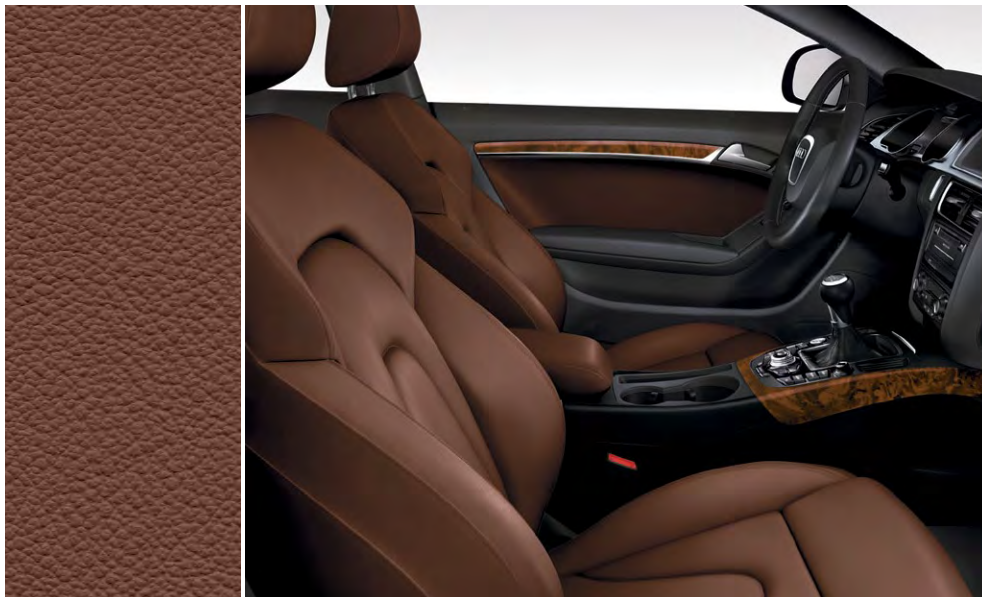

BLACK LEATHER/PERFORATED ALCANTARA* | BRUSHED ALUMINUM INLAY [S line® only]



S5 Interior Seating | Decorative Inlay

PEARL SILVER SILK NAPPA LEATHER | BRUSHED ALUMINUM INLAY*



DECORATIVE INLAY OPTIONS

BRUSHED ALUMINUM INLAY <small>(Standard)</small>
CARBON FIBER INLAY <small>(Option)</small>
GRAY BIRCH WOOD INLAY <small>(Option)</small>
STAINLESS STEEL TEXTURE INLAY <small>(Option)</small>

MAGMA RED SILK NAPPA LEATHER | CARBON FIBER INLAY*



* Optional inlay shown
* Includes Piano Black inlay on center console

TUSCAN BROWN SILK NAPPA LEATHER | GRAY BIRCH WOOD INLAY*



BLACK SILK NAPPA LEATHER/BLACK ALCANTARA® | STAINLESS STEEL TEXTURE INLAY*



BLACK SILK NAPPA LEATHER | CARBON FIBER INLAY*



BLACK SILK NAPPA LEATHER/SILVER ALCANTARA® | STAINLESS STEEL TEXTURE INLAY*



A5 S5 Make yours.



A5 Monza Silver[†] METALLIC[‡]



A5 Misano Red[†] PEARL EFFECT[‡]



A5 Sahara Silver[†] METALLIC[‡]

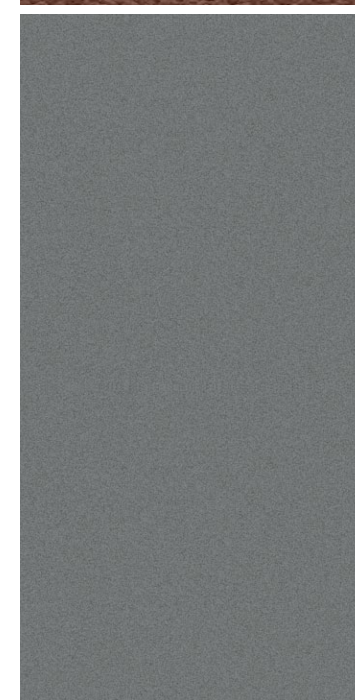
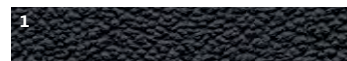

- 1 | Black^{*}
- 2 | Light Gray^{*} [A5 only]
- 3 | Linen Beige^{*} [A5 only]
- 4 | Cinnamon Brown^{*} [A5 only]
- 5 | Pearl Silver [S5 only]
- 6 | Magma Red [S5 only]
- 7 | Tuscan Brown [S5 only]
- 8 | Black/Silver Alcantara[†] [S5 only]

* Available in Milano leather, leather/perforated Alcantara[®], Silk Nappa leather and Silk Nappa leather/Alcantara[®]

† Available in leather and Milano leather

‡ S line[®] only

§ Additional charge



A5 Teak Brown METALLIC⁵



A5 S5 Ibis White



A5 S5 Brilliant Red



A5 S5 Ice Silver METALLIC⁵



A5 S5 Brilliant Black

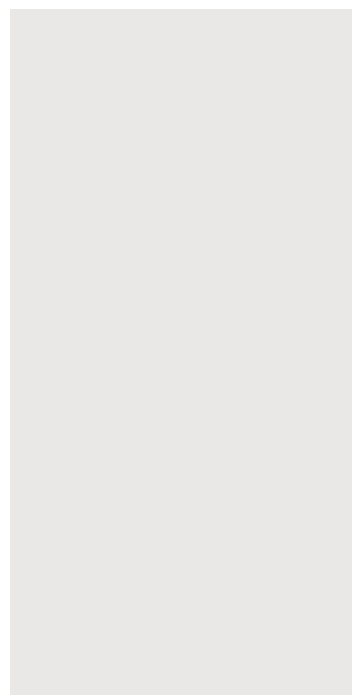
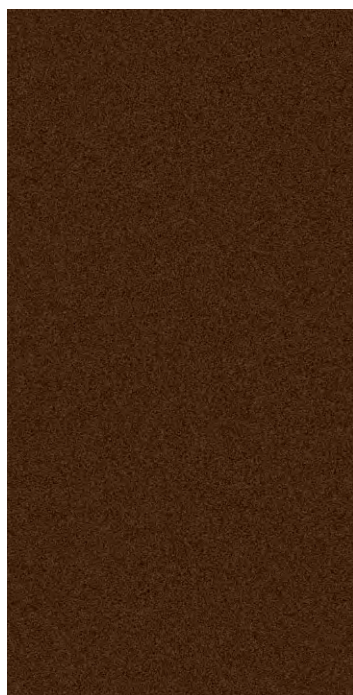



A5 S5 Quartz Gray METALLIC⁵



A5 S5 Deep Sea Blue PEARL EFFECT⁵



A5 S5 Meteor Gray PEARL EFFECT⁵



S5 Phantom Black PEARL EFFECT⁵



S5 Sprint Blue PEARL EFFECT⁵

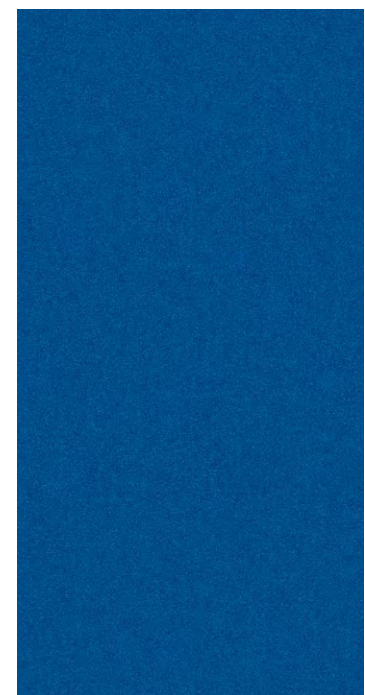
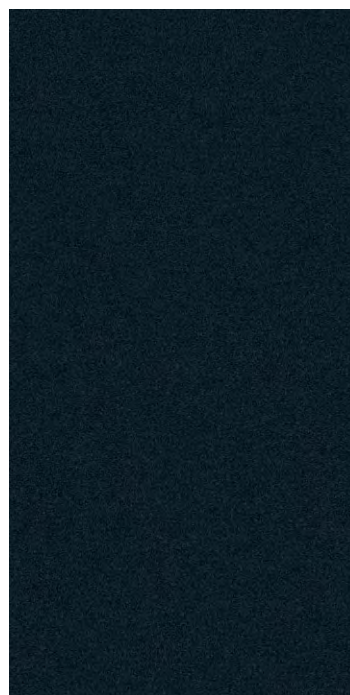
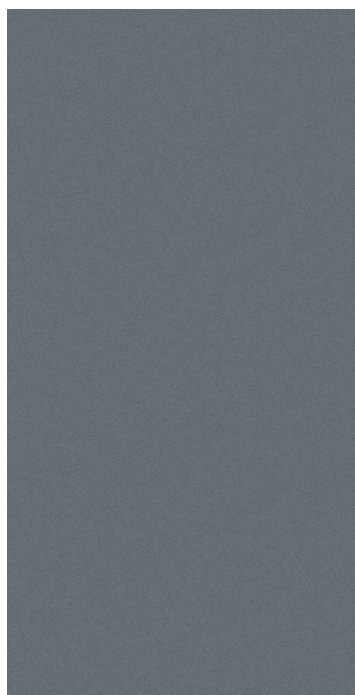

A5 S5 Specifications | Configurations

Chassis Technical	A5	S5
Five-link front suspension with upper and lower control arms, stabilizer bar and individual, gas-charged coil springs/shock absorbers	S	S
Independent trapezoidal-link rear suspension with rigid subframe, stabilizer bar and individual, gas-charged coil springs/shock absorbers	S	S
Servotronic® speed-sensitive power steering – varies assistance based on vehicle speed	S	S
quattro® permanent all-wheel drive system utilizing torque-sensing center differential – 40:60 rear-biased torque split	S	S
quattro with Sport Rear Differential permanent all-wheel drive system utilizing torque-sensing center differential – 40:60 rear-biased torque split and variable torque application between rear wheels	-	0
Sport suspension calibration	0	-
S5 sport suspension calibration	-	S
Six-speed manual transmission	S	S
Eight-speed Tiptronic® automatic transmission	0	-
Six-speed Tiptronic® automatic transmission	-	0
Fully galvanized steel unibody with multistep anti-corrosion protection	S	S

Safety Security	A5	S5
Driver and front passenger advanced dual-stage airbag* supplemental restraints	S	S
Driver and front passenger seat-mounted side thorax airbag* supplemental restraints	S	S
Sideguard® head curtain airbags* for both rows of seats	S	S
Front passenger occupant detection for airbag* supplemental restraints	S	S
Front three-point safety belts with automatic pre-tensioning and force limiters; height adjustable for front seating positions	S	S
Rear three-point safety belts with belt force limiters for outboard passenger seating positions	S	S
Safety belt reminder for driver and front passenger	S	S
Lower Anchors and Tethers for CHildren (LATCH) in rear seats	S	S
Pinch protection for front windows	S	S
Impact protection – including reinforced high-strength steel/aluminum cross members, reinforced bumpers and rigid occupant cell	S	S
Tire pressure monitoring system	S	S
Electronic Stabilization Program (ESP®)	S	S
Anti-lock Brake System (ABS) with Electronic Brake-pressure Distribution (EBD)	S	S
Brake assist – a system that automatically senses emergency braking and applies maximum power boost to reduce overall stopping distance	S	S
Front ventilated disc brakes	S	S
Rear disc brakes	S	-
Rear ventilated disc brakes	-	S
Anti-theft vehicle alarm system with blinking theft-deterrent light	S	S

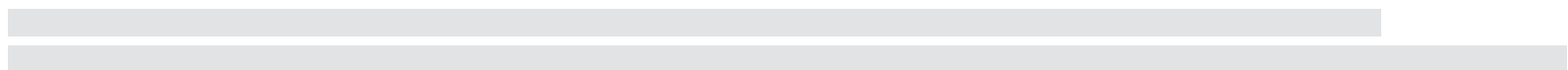

Interior	A5	S5
Leather-wrapped, three-spoke, multifunction sport steering wheel with controls for audio volume, Bluetooth* phone and audio seek functions	S	S
Shift paddles on steering wheel [Tiptronic* automatic transmission]	0	S
Tilt and telescopic manually adjustable steering column	S	S
Storage nets on backs of front seats	S	S
Dual front sun visors with lighted vanity mirror for driver and front passenger	S	S
Leather seating surfaces	S	-
Leather seats with perforated Alcantara* inserts	0	-
Silk Nappa leather upholstery	-	S
Silk Nappa leather with Alcantara inserts	-	0
Eight-way power driver seat with four-way power lumbar adjustment	S	-
Eight-way power passenger seat	S	-
Eight-way power sport front seats with four-way power lumbar adjustment and extendable thigh support	0	-
Eight-way power S5 sport seats with integrated head restraints, four-way power lumbar adjustment, and extendable thigh support	-	S
Memory for driver seat adjustment and exterior mirrors	0	0
Six-step, heated front seats	0	S
Split folding 50/50 rear seatback	S	S
Backlit instrument cluster with brightness control	S	S
Tilting glass panorama sunroof	S	S
Automatic climate control	S	-
Three-zone automatic climate control	0	S
Power windows with one-touch up/down operation and pinch protection	S	S
Center armrest with height and forward/backward adjustment	S	S

Exterior	A5	S5
LED turn signals in mirror housings	S	S
Chrome trim around exterior windows	S	S
Dual exhaust pipes on left side	S	-
S quad exhaust pipes	-	S
Halogen headlights with integrated high and low beams	S	-
Audi xenon plus headlights with automatic self-leveling and integrated LED daytime running lights	0	S
LED taillights	0	S
Two front fog lights located in lower front bumper	S	S
Heated windshield wiper nozzles	S	S
Power-adjustable heated side mirrors [body color on A5; Aluminum Optic on S5]	S	S
Headlight washers – high-pressure, retractable and heated	-	S
Metallic/pearl effect paint	0	0

Infotainment Technology	A5	S5
Audi concert system with single CD player with MP3 playback capability, AM/FM radio, auxiliary input jack, SD* card slot for MP3 files and speed-dependent volume control	S	S
SIRIUS* Satellite Radio with three-month trial subscription	S	S
Audi Sound System, 180 watts with ten speakers, including a subwoofer and center fill speaker	S	S
Bang & Olufsen* Sound System – 505 watt audio system with 14 speakers and ten-channel amplifier	0	0
Audi Navigation plus* with 3rd generation MMI*, hard-drive navigation, one DVD player, AM/FM radio, two SD card slots for MP3 files, and HD Radio™ Technology	0	0
Audi music interface with iPod* and iPhone* integration	0	S
Voice control for navigation, directory and telephone	0	0
Bluetooth** preparation for mobile phone	0	S
Driver information system – trip computer, outside temperature, radio/telephone/navigation display, Auto-Check, open door/deck lid indicator	S	S
Audi advanced key – keyless start, stop and entry	0	0
Electronic cruise control	S	S
Adaptive cruise control, maintains preset distance from vehicle in front	0	0
Automatic light switch controlled by light sensor, “coming home” and “leaving home” functions	0	S
Rain sensor for automatic windshield wipers	0	S
HomeLink* universal remote	0	S

-	Not Available	0	Option	S	Standard
---	---------------	---	--------	---	----------

The table above represents the standard equipment on the A5 Premium model and S5 Premium Plus model. Many popular options are combined and available on the Premium Plus and Prestige models. Please see the package contents in this brochure for complete details.

* Airbags are supplemental restraints only and will not deploy under all crash circumstances. Always use safety belts and seat children in the rear, using restraint systems appropriate for their size and age.

* Audi Navigation plus depends on signals from the worldwide Global Positioning Satellite network. The vehicle's electrical system, and existing wireless and satellite technologies, must be available and operating properly for the system to function. The system is designed to provide you with suggested routes in locating addresses, destination and other points of interest. Changes in street names, construction zones, traffic flow, points of interest and other road system changes are beyond the control of Audi of America, Inc. Complete detailed mapping of lanes, roads, streets, toll roads, highways, etc., is not possible; therefore, you may encounter discrepancies between the mapping and your actual location. Please rely on your individual judgement in determining whether or not to follow a suggested Audi Navigation plus route. Periodically, the mapping is updated, and a new DVD will be required in order to maintain the latest navigation information available to us. These will be available for purchase from time to time at an additional cost. Consult your dealer or call 1-800-FOR-AUDI for details.

* Your Audi vehicle is equipped with a phone preparation utilizing Bluetooth interface to enable hands-free functionality [compatible mobile phones sold separately]. You will need a Bluetooth-enabled mobile phone in order to utilize this function. Not all Bluetooth-enabled mobile phone models are compatible with Audi phone preparation. Visit audiusa.com/bluetooth, or contact your local Audi dealer for the latest listing of compatible phones. Audi recommends use of the Audi phone cradle [sold separately] with your mobile phone while operating this vehicle.

A5 Model Configurations

2.0 TFSI® with six-speed manual transmission and quattro® all-wheel drive

2.0 TFSI with eight-speed Tiptronic® transmission and quattro all-wheel drive

Power and Performance

2.0 liter turbocharged with intercooler, DOHC in-line four-cylinder gasoline engine with FSI® direct injection, variable valve timing and Audi valvelift system

+ Horsepower: 211hp @ 4300-6000 RPM

Torque: 258 lb-ft. @ 1500-4200 RPM

+ 0-60 MPH in seconds – Manual: 6.4, Tiptronic: 6.6

Top track speed*: 130 MPH

+ Fuel economy estimate, city/highway†:
Manual: 22/30 MPG; Tiptronic: N/A

S5 Model Configurations

4.2 FSI with six-speed manual transmission and quattro all-wheel drive

4.2 FSI with six-speed Tiptronic transmission and quattro all-wheel drive

Power and Performance

4.2 liter DOHC V8 gasoline engine with FSI direct injection, variable valve timing and intake manifold

+ Horsepower: 354hp @ 7000 RPM

Torque: 325 lb-ft. @ 3500 RPM

+ 0-60 MPH in seconds: 4.9

Top track speed*: 155 MPH

+ Fuel economy estimate, city/highway†:
Manual: 14/22 MPG; Tiptronic: 16/24 MPG

A5 S5 Dimensions

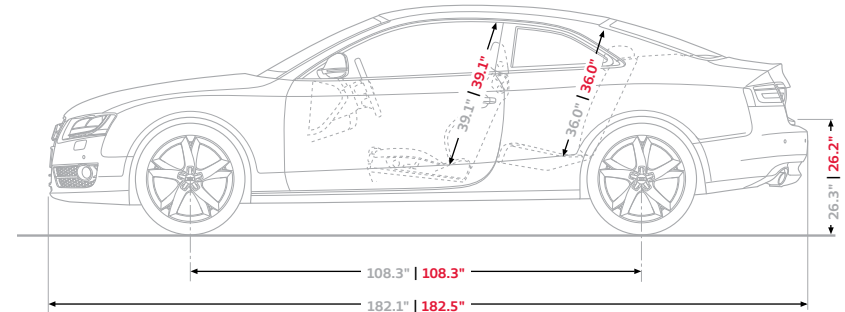
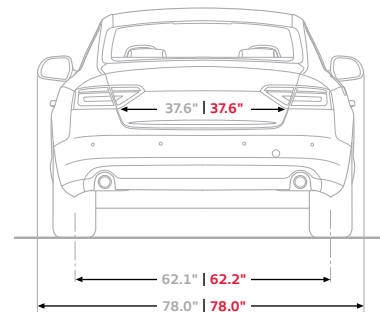
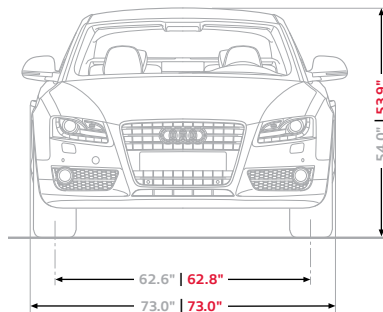

* Top track speed for A5 electronically limited to 130 MPH in the U.S. Obey all local speed and traffic laws. † Top track speed for S5 electronically limited to 155 MPH in the U.S. Obey all local speed and traffic laws. ‡ EPA fuel economy estimates. Your mileage will vary.

2011 | A5 S5

Audi of America

Audiusa.com

[Facebook.com/Audi](https://www.facebook.com/Audi)

BR-A5Coupe-10-1400US

Note: A word about this brochure. Audi of America, Inc. believes the specifications in this brochure to be correct at the time of printing. However, specifications, standard equipment, options, and colors are subject to change without notice. Some equipment may be unavailable when your vehicle is built. Please ask your dealer for advice concerning current availability of standard and optional equipment, and your dealer will verify that your vehicle will include the equipment you ordered. Vehicles in this brochure are shown with optional equipment. See your dealer for complete details on the new-vehicle limited warranty, twelve-year limited warranty against corrosion perforation, and Audi 24/7 Roadside Assistance. [Roadside assistance coverage provided by Road America in the U.S. Certain conditions apply; see your dealer for details.] Tires supplied by various manufacturers. "Truth in Engineering" is a registered trademark of Audi of America, Inc. "Audi;" "quattro;" all model names, "MMI," "FSI," "Sideguard," "Singleframe," the Singleframe grille design, and the four rings logo are registered trademarks of AUDI AG. "Servotronic" is a registered trademark of the AM General Corporation. "Tiptronic" is a registered trademark of Dr. Ing h.c. F. Porsche AG. "Alcantara" is a registered trademark of Alcantara S.P.A. "ESP" is a registered trademark of Daimler AG. "HomeLink" is a registered trademark of Prince Corporation, Holland, Michigan. "SIRIUS" is a registered trademark of SIRIUS Satellite Radio, Inc. "Bluetooth" is a registered trademark of Bluetooth SIG. "iPod" and "iPhone" are registered trademarks of Apple Computer, Inc. HD Radio" and the HD Radio logo are proprietary trademarks of iBiquity Digital Corporation.

©2010 Audi of America, Inc.