

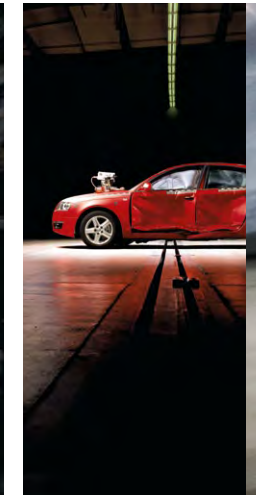

# A5 S5

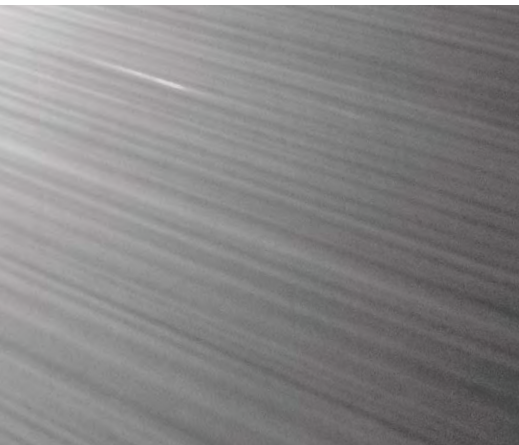

substance always wins the day

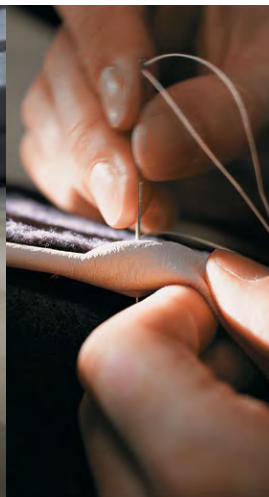

It takes more than hard work, dedication and vision to create the truly exceptional. It takes something intangible. Something you can't quite put your hands on. It's courage, guts, perseverance, passion and fierceness of focus all wrapped into one.

And it's this intangible characteristic that defines all of us at Audi. It's the driving force behind

every pencil line we draw, every calculation we make and every idea we deem not good enough.

It's why every inch and curve and angle has purpose. It's why we test our cars at the highest of speeds for hours on end so they can be driven on any surface and in any condition - rain, shine or white-out blizzard.

It's why substance always wins the day. It's why cutting a corner, even a weld seam in the trunk, would be sacrilegious. And it's why for us scrutiny is so deeply ingrained it's like the very act of breathing.

This is Truth in Engineering. And this is Audi.



A5 Cabriolet Prestige



a badge doesn't define you  
it represents you

## Contents

- 
- ▶ 6-11 The A5 Cabriolet Experience
- 
- ▶ 12-17 The S5 Cabriolet Experience
- 
- ▶ 18 quattro®
  - ▶ 20 Performance
  - ▶ 22 MMI®
  - ▶ 24 Safety
  - ▶ 26 Handling
- 
- ▶ 28 A5 Cabriolet Premium | Premium Plus
  - ▶ 32 A5 Cabriolet Prestige | Packages
  - ▶ 36 A5 Cabriolet Options | S5 Cabriolet Premium Plus
  - ▶ 40 S5 Cabriolet Prestige | Packages
  - ▶ 44 S5 Cabriolet Options | Accessories
  - ▶ 48 Wheels
  - ▶ 52 A5 Cabriolet Interior Colors
  - ▶ 54 S5 Cabriolet Interior Colors
  - ▶ 56 Exterior Colors
  - ▶ 59 Specifications | Configurations
-

# vivacious

The A5 Cabriolet is a special experience. The sun, the scents, the world itself is invited to ride along with you. As the only car in its class to offer quattro® all-wheel drive, the A5 Cabriolet is a progressive take on top-down driving. Derived from the A5 Coupe and heralded as “Design of the Year” by *AUTOMOBILE Magazine*; its evocative shape demands attention.

The exterior features a bold front-end design highlighting the iconic, signature Singleframe® grille and striking available LED daytime running lights.

The perfect proportions are further complemented by the graceful Tornado line that spans the length of the car, accentuating the 18" alloy wheels and sculpted fenders. It creates a look of motion – even when the car is standing still.

The aluminum windshield frame adds a sophisticated finishing touch to the clean lines of the A5 Cabriolet. The total look is elegant and refined, giving it a distinctive presence that begs to be driven.



# A5

\* *AUTOMOBILE Magazine*, December 2008.



A5 Cabriolet S line®





A5 Cabriolet Prestige



# priorities

Sleek, uncomplicated design reflects the attention to detail that's found throughout the interior of the A5 Cabriolet. The clean lines of the interior belie its functionality. In true Audi fashion, the sophisticated cockpit is oriented toward the driver to maximize your driving experience.

As part of that experience, intelligently designed functionality is essential. The available integrated head-level heating system and heated and cooled seats are designed to keep you comfortable year-round. Offering comfortable seating for four, the A5 Cabriolet is the only car in the

category to provide split-folding rear seats with a full pass-through.

Thoughtful innovation is carried through at every level. The high-mounted display screen allows you to keep your eyes forward as you navigate the MMI® system, while the rear seat passengers can enjoy the LED map lights in the high-tech Audi acoustic roof.

With unmatched attention to detail and the finest materials possible, the A5 Cabriolet sets the standard for a luxurious driving experience, regardless of whether the top is up or down.



# accelerated

From the innovative convertible top to class-leading fuel efficiency\*, the A5 Cabriolet employs several progressive technologies that keep it well ahead of the competition. One of them is quattro®, which offers the traction and handling of four driven wheels. The second is the award-winning 2.0 TFSI® engine offering the best-in-class combination of fuel efficiency and power. It's engineered to deliver 211hp and 258 lb-ft. of torque – while offering 22 MPG city and 30 MPG highway. It's the power of a six-cylinder engine with the efficiency of a four-cylinder.

The soft top is another breakthrough in engineering. It not only saves weight but folds compactly to allow for maximum trunk storage. It also adds a level of comfort by keeping the interior as quiet as a traditional hard top. And to keep you moving, it can be retracted in 15 seconds at speeds of up to 30 MPH.

From its best-in-class performance to the innovative roof, the A5 Cabriolet delivers an experience few convertibles are capable of. Unless, of course, it's an Audi.



\* EPA estimate: 22/30 city/highway MPG. Your mileage will vary.



A5 Cabriolet S line®

# dynamic

---

\$5



The 333hp S5 Cabriolet is pure performance with the top down. Its wide, low-slung stance and large wheels create a lean, aggressive look. The LED daytime running lights surrounding the

platinum Singleframe® grille with distinctive vertical chrome accents and S5 badge create a look of forward momentum. Add the sport-oriented look of unique S design elements

like the Aluminum Optic front and rear diffuser blades and the powerful quad exhaust, and there's no question the S5 Cabriolet is about pure performance.



S5 Cabriolet Prestige



# adapt

Audi design and benchmark craftsmanship can be found end to end in the S5 Cabriolet. The beautifully crafted bicolor Silk Nappa sport seats with integrated head restraints, prominent side bolsters and extendable thigh supports hold you firmly as you dive into curve after curve. Even the special S5 gauges and available Carbon Fiber inlays reaffirm its track-inspired pedigree.

Further driving home its performance heritage, the three-spoke, multifunction, sport steering wheel with Aluminum Optic shift paddles offers a confidence-inspiring solid feel.

Performance and luxury blend perfectly in the S5 Cabriolet to deliver a thoroughly exhilarating driving experience.



S5 Cabriolet Prestige



V6T



SS



S5 Cabriolet Prestige



# commanding

When unleashed, the 3.0 TFSI® engine commands respect. Producing a prodigious 333hp and 325 lb-ft. of torque, going from 0-60 MPH takes a mere 5.1 seconds. Naturally, part of the credit goes to the rapid-shifting, dual-clutch, seven-speed S tronic® transmission and the responsiveness of Audi FSI® direct injection.

Channel all of that power through the specially calibrated S sport suspension and the torque vectoring capabilities of quattro® with available Sport Rear Differential, and you'd better hold on. Further enhance your experience with the available Audi drive select for personalized driving characteristics. The S5 Cabriolet is about total performance, creating an experience that will leave an indelible impression.

- 1** The Roots-style, four-vane supercharger delivers outstanding acceleration at any RPM.
- 2** The dual-clutch technology delivers gear changes in a blistering 0.2 seconds, allowing you to keep the power on even between gears.
- 3** Audi drive select offers four distinct settings: Comfort, Dynamic, Auto and Individual. Between them there are 27 settings, allowing you to personalize the handling characteristics of your S5 Cabriolet.
- 4** The S tuned suspension is designed to offer a sportier driving experience by minimizing body roll and allowing for more responsive and confidence-inspiring handling.
- 5** quattro with Sport Rear Differential senses which rear wheel to deliver an optimum level of torque. By directing most of the power to the outer rear wheel, quattro with Sport Rear Differential helps steer the S5 Cabriolet through the corner.

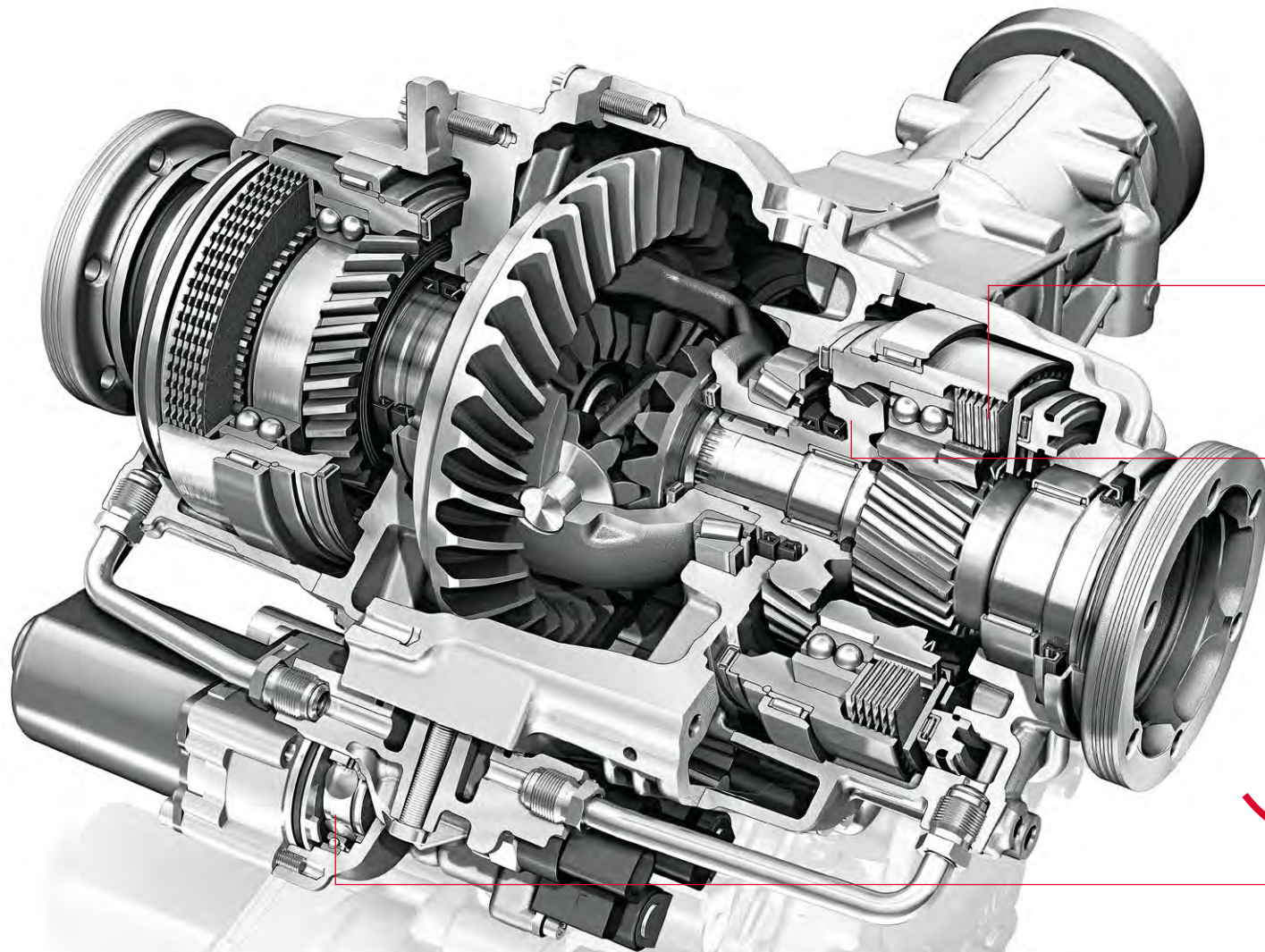

**Clutch in Power Flow:**  
Minimal drag losses  
Highest actuation dynamics  
Optimal control accuracy

**Overdrive Speed Difference  
via Internal Step Gear:**  
Compact design  
Minimal weight  
Optimal efficiency  
Instantaneous response

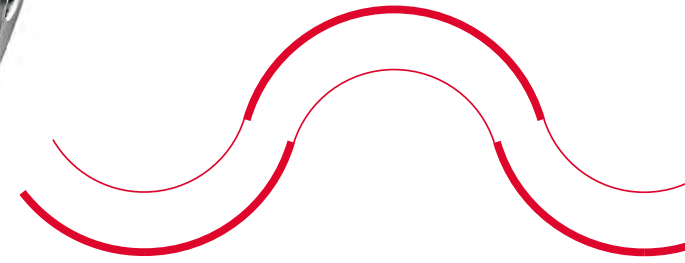

**Hydraulic Actuation:**  
Optimal control  
Highest power density

get ready, this is where  
it becomes visceral



# awe

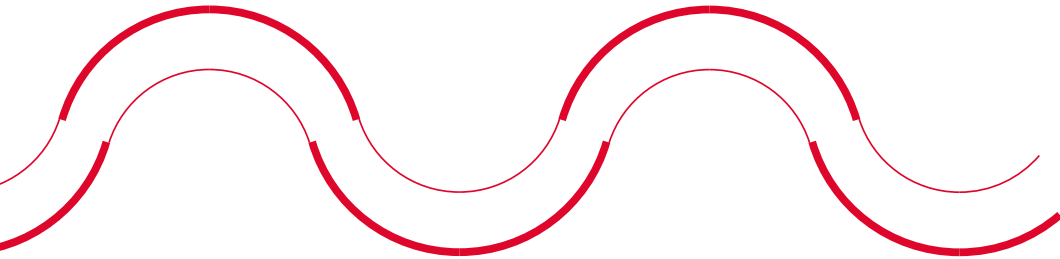

The concept is ingenious, the solution brilliant. Often imitated, nothing drives like quattro®, the world's most innovative all-wheel drive system. It's a technology that we've been developing for 30 years. And the competition? They're just now beginning to realize what we've known for three decades.

For you, quattro means unmatched traction and confidence in less-than-ideal driving conditions and unequalled performance all other times.

Permanent all-wheel drive systems are not created equal. And they certainly don't perform that way either. quattro is essentially a mechanical

system devised around a torque-sensing self-locking center differential that shifts torque instantaneously to where it's needed. This means quattro is adjusting power between front and rear axles more than 100 times a second, ensuring torque is delivered to the wheels where traction exists.

In normal driving situations, quattro distributes the power between each axle by sending 40 percent to the front wheels and 60 percent to the rear wheels, enhancing the driving dynamics while maintaining optimum control. Constantly assessing grip, quattro helps



ensure the best possible combination of traction and handling regardless of the road conditions.

quattro with Sport Rear Differential additionally senses which rear wheel to deliver an optimum level of torque. Specifically, it directs most of the power to the outer rear wheel to help steer the car through the corner. This reduces understeer, common among other all-wheel drive systems, and creates the true sportscar handling found in an Audi. The difference between other all-wheel drive systems and quattro is nothing less than dramatic.

What you experience behind the wheel is confidence-inspiring handling. Curves are relished. Rain and snow are greeted with relative indifference. And every drive is an experience in performance bliss.



30  
years of quattro®

# performance fueled by unconventional thinking

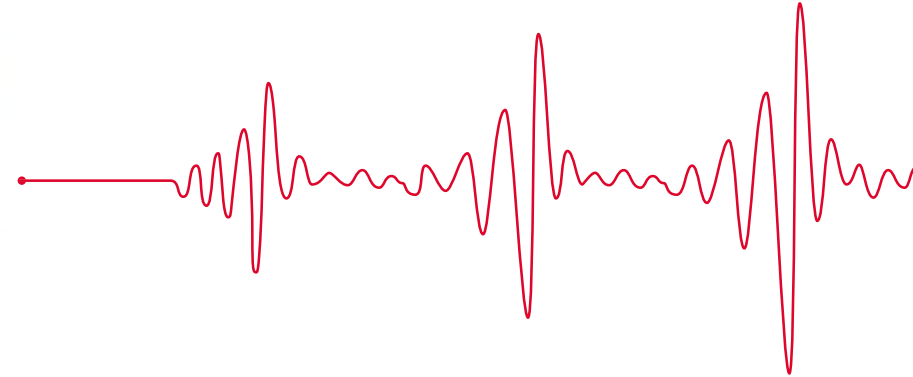

## FSI®

Audi Fuel Stratified Injection, or FSI®, offers the benefits of increased performance and fuel efficiency.\* FSI direct injection delivers a precise amount of fuel directly into the engine cylinders, as opposed to the engine intake runners. This advanced process helps ensure a more complete combustion, thereby diminishing waste and increasing power.

Additionally, the specially designed piston heads compress the fuel-air mixture in a spiraling motion, creating the most efficient combustion possible. Making the

most of these technologies allows for greater efficiency in the combustion process.

By combining FSI and forced induction, such as a turbocharger or supercharger, the 2.0T and 3.0T engines employ a variation of FSI called TFSI®. The principle and benefits are identical. TFSI-equipped engines take advantage of significantly higher compression ratios and cylinder pressure, thus fully atomizing fuel and optimizing boost response. The compressor condenses the air flowing into the engine, allowing more air into the cylinder and therefore

more power from each ignition. A forced-induction engine produces greater power than a similar engine without it, significantly improving the engine's power-to-weight ratio. Consequently, Audi is able to use smaller, more efficient engines and achieve similar power and performance results typically found in larger, less fuel-efficient engines.

The beauty of FSI and TFSI is that they work at any RPM, maximizing efficiency and generating responsive and optimal power during all driving conditions.

## Audi Valvelift System

Audi valvelift system helps elevate the performance characteristics of variable valve timing. The result is smooth power buildup, instantaneous throttle response and up to a 7 percent reduction in fuel consumption.

Audi valvelift system intelligently varies the lift and duration of engine exhaust valves in response to engine load and power needs. Optimizing air management, Audi valvelift system helps create maximum torque across a broad range of RPM without sacrificing efficiency.

# pulse

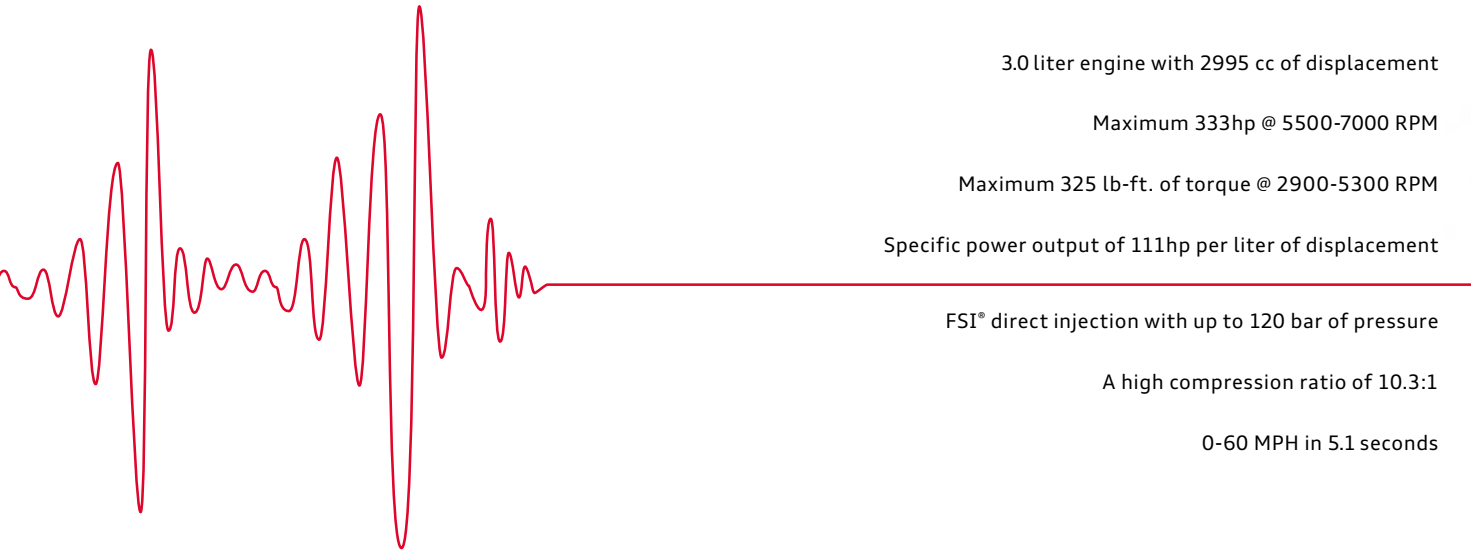

3.0 liter engine with 2995 cc of displacement

Maximum 333hp @ 5500-7000 RPM

Maximum 325 lb-ft. of torque @ 2900-5300 RPM

Specific power output of 111hp per liter of displacement

FSI® direct injection with up to 120 bar of pressure

A high compression ratio of 10.3:1

0-60 MPH in 5.1 seconds



## 2.0 TFSI®

The Audi 2.0 liter turbocharged DOHC engine was named one of Ward's "10 Best Engines"™ for the fifth year in a row as well as "International Engine of the Year"™\* for the fifth time.

Years ahead of the competition, it combines Audi valvelift system, variable valve timing, TFSI® direct injection and turbocharging for more power and greater efficiency. The 2.0 TFSI was the first engine to combine gasoline direct injection with turbocharging in large-scale production. Producing 211hp and 258 lb-ft. of torque, it has been the engine of choice for more than 1.3 million Audi drivers worldwide.

## 3.0 TFSI

The Audi 3.0 liter TFSI engine has been named one of Ward's "10 Best Engines"™ in its first year of production. The 3.0 liter, all-aluminum V6 benefits from the combination of FSI direct injection and supercharging to create 333hp and 325 lb-ft. of torque. The impressive torque is generated over a wide range, from 2900 to 5300 RPM, making full power usable at any speed. The four-vane Roots-style supercharger makes the 3.0 liter V6 exceptional. The potent combination of FSI with supercharging allows Audi to achieve V8 power and torque with the efficiency of a V6.

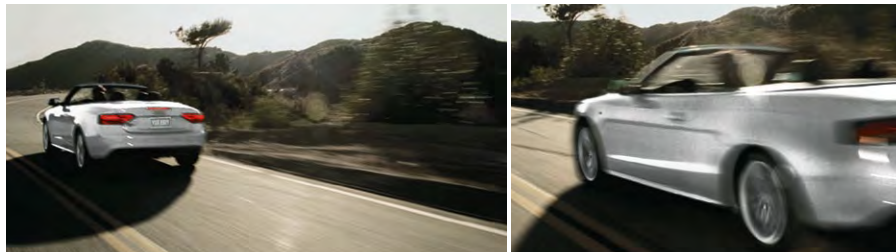

\* EPA estimates: 22/30 city/highway MPG. Your mileage will vary.  
† WardsAuto.com, December 2009. ‡ Based on 1.8 to 2.0 liter category.

# connected

---

customizing nearly every aspect  
of your driving experience

## ■ Car Setup

The personalization of your vehicle settings can be managed through the MMI® system, enabling you to set your preference for daytime running light settings, central locking features, the audio system, date and time format, and windshield wiper settings, as well as monitor your service intervals. Individual preferences are all accessed, modified and stored via MMI.

When equipped with Audi drive select, the MMI system enables you to choose your preferred settings for ride comfort and handling.

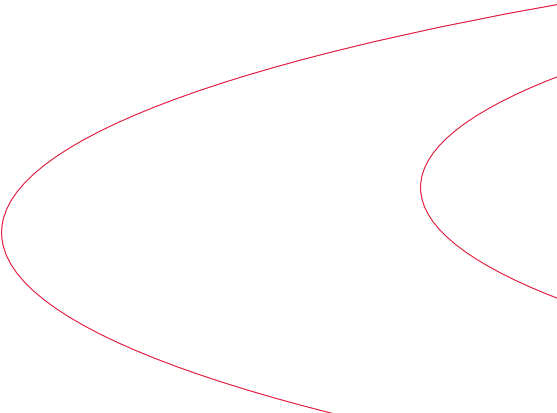
A red abstract graphic consisting of several overlapping, curved lines that form a shape resembling a stylized car wheel or a dynamic motion path, located in the bottom right corner of the page.

The easy-to-use MMI® (Multi Media Interface) operating system allows you to access various vehicle systems, such as navigation, radio, telephone and car setup, to optimize your driving experience.

The MMI control knob with integrated joystick, located near the shift lever, allows you to navigate various system functions easily without diverting

your eyes from the road. The system inputs, selections and options are displayed on the high-definition MMI screen.

Audi was the first manufacturer to use an automotive-grade NVIDIA® chip in the navigation system that offers high-quality on-screen graphics. The result is smooth, zoom-in and zoom-out

functionality and crisp, 3D graphics of buildings and topography for easier navigation.

At its core, the MMI system has a central media and communications computer that controls the navigation functions, the Bluetooth® universal mobile phone preparation, and media with integral DVD drive and a 40-GB hard drive.

When equipped with the Audi music interface (AMI), an iPod® and other mobile media players can be accessed via the MMI system for easy music selection.

From music to navigation and more, the MMI system is your pathway to truly personalizing your driving experience.

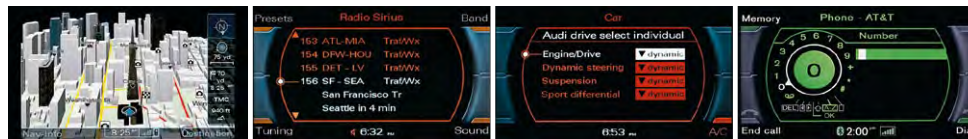

### Media

Managing your entertainment options with the MMI system is effortless. With a simple push of a button, MMI allows you to select among the radio tuner, CD/DVD player, AMI or the integrated hard drive. The hard drive allows you to preload 10-GB of personal audio files. Using the control knob, the media source menu and music options are easily viewed on the high-definition MMI screen. Once a selection is made, the track name is displayed.

### Radio

In addition to offering analog, HD Radio™ Technology and SIRIUS® Satellite Radio tuning, MMI allows you to tune the receiver by scrolling through your preset radio stations; adjust the audio settings, and customize the listening experience by tailoring the speaker output. You can also preview what's playing on SIRIUS Satellite Radio stations without changing the station you're currently listening to.

### Telephone

The MMI system offers integrated Bluetooth technology to support more than one Bluetooth-compatible mobile phone. The system allows the driver or passengers to seamlessly switch among the supported phones and their listings as well as the contacts stored in the MMI system.

### 3D Navigation

The map displayed on the MMI screen is shown in a three-dimensional topographical format. For added convenience, a large number of cities are displayed in a detailed, three-dimensional format, visually articulating building and road specifics for easier readability.



# confidence

we've got your back, front, sides and top

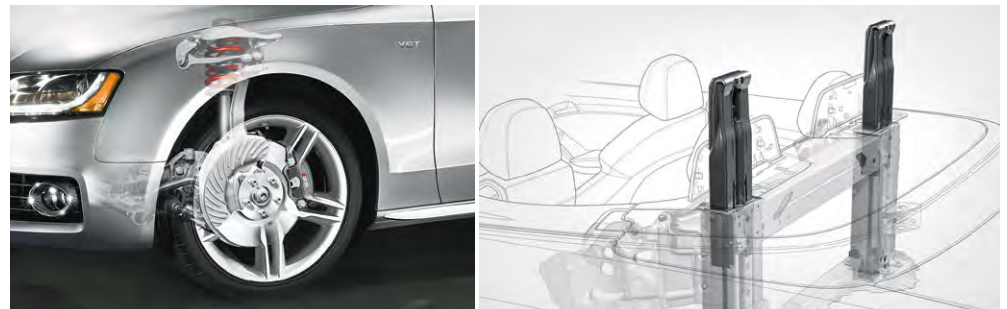

Audi has always held firm the belief that prevention is the best safety feature of all. And the Audi A5 Cabriolet and S5 Cabriolet offer an abundance of features designed to help keep you out of harm's way. For instance, the Electronic Stabilization Program (ESP®) helps keep the vehicle traveling in its intended direction by utilizing ABS, the traction control of ASR and the electronic brake force distribution of EBD.

Audi has implemented a number of ingenious features to help maximize braking effectiveness. In wet conditions, the brake disc wiping system gently pulses the brakes to help dissipate water buildup. Keeping the discs as dry as possible

helps promote the most effective braking. Additionally, the brake assist system is able to detect an attempt at full braking and apply full stopping power when required. The advantage is that braking distance is significantly reduced.

Inside, the Audi safety systems prepare for the worst once the brake assist system is engaged. The safety belt pre-tensioners are activated, for all occupants, and lock the safety belts in place. This is intended to help keep passengers in the safest position in the event of a collision.

When prevention isn't enough, the combination of crumple zones and high-strength steel helps

deliver a tremendous level of protection for the driver and passengers. Crumple zones, at the front and rear of the vehicle, are designed to dissipate the energy and force of a collision by deforming upon impact. The high-strength steel used in and around the occupant cell is designed to protect the integrity of the passenger compartment and those within it.

Aside from a rollbar that rapidly deploys in the event of a rollover, six standard, second-generation airbags\* also provide an additional measure of safety. They include front-impact airbags for the driver and passenger and are designed to help protect the head.

Seat-mounted, side-impact airbags for the front seat occupants are designed to help protect the thorax in a collision and knee airbags are designed to offer lower extremity protection.

Reacting to rear collision forces, the head restraints help cradle the occupant's head in an effort to reduce the likelihood of a whiplash injury.

Everything comes together to reinforce our commitment to all-encompassing safety.



We have 30 years of experience in developing the world's most sophisticated all-wheel drive system. The result is quattro®. It helps maximize traction by automatically adjusting power to each wheel, making the car feel planted – regardless of conditions. Combine ESP and race-bred braking technology, and you'll feel a level of confidence you've never experienced before.

- ▶ quattro helps increase your margin of safety by helping you maintain maximum traction in a variety of weather conditions.
- ▶ ESP helps ensure your vehicle maintains the intended direction of travel by continuously adjusting a number of drivetrain variables.
- ▶ Four-wheel disc brakes with brake disc wiping offer optimal braking in all kinds of weather.

\* Airbags are supplemental restraints only and will not deploy in all crash circumstances. Always use safety belts and seat children in the rear, using restraint systems appropriate for their size and age.

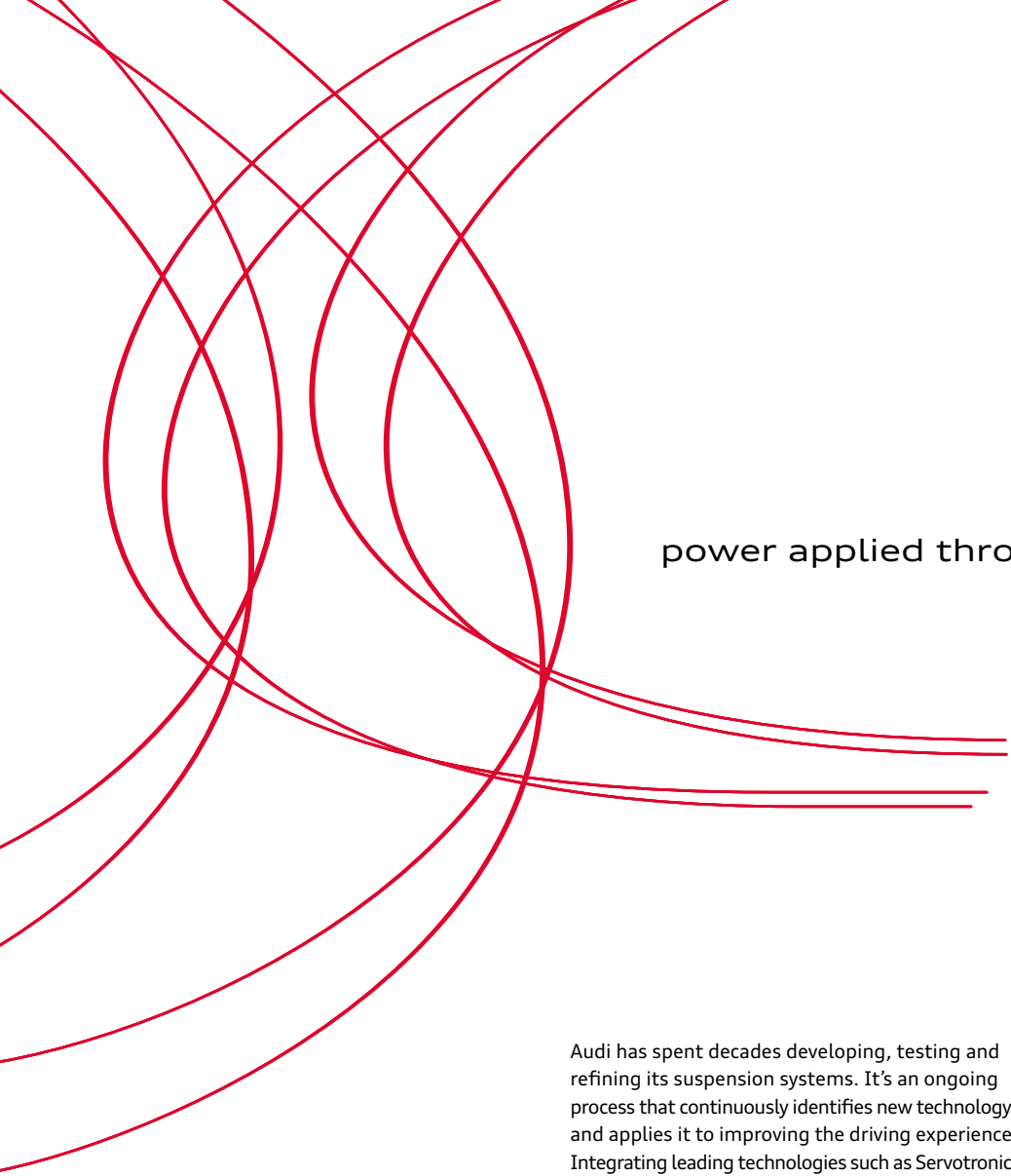

power applied through sophisticated engineering for legendary handling

# planted

Audi has spent decades developing, testing and refining its suspension systems. It's an ongoing process that continuously identifies new technology and applies it to improving the driving experience. Integrating leading technologies such as Servotronic® speed-sensitive steering and quattro® all-wheel drive with finely tuned brakes and a rigid chassis result in the refined handling dynamics for which Audi is famous. The suspension system in an Audi consistently delivers precise steering feel, exceptional ride comfort and sharp handling.

#### ■ Five-link Front Suspension

With the finely tuned front-suspension components secured to the subframe, the five-link front suspension increases ride quality by isolating road harshness and vibration from the cabin. The use of weight-saving aluminum for critical components helps reduce unsprung mass at each wheel, allowing the suspension to respond more rapidly. The net effect is a driving experience that is extremely responsive, smooth and predictable. It is handling that has become an Audi hallmark.

#### ■ Rear Suspension

The self-tracking, trapezoidal-link rear suspension provides an incomparable level of driving dynamics. This structure offers a high degree of stiffness that helps ensure precise handling, while the control arm components absorb a great deal of the force encountered by the wheels. The combination helps improve handling response while dampening the abrupt impacts commonly encountered while driving. Additionally, the wheel-guidance components are fixed to the subframe with both rubber and metal bushings to further isolate vibrations from the occupant cell, ensuring a quieter, smoother driving experience.

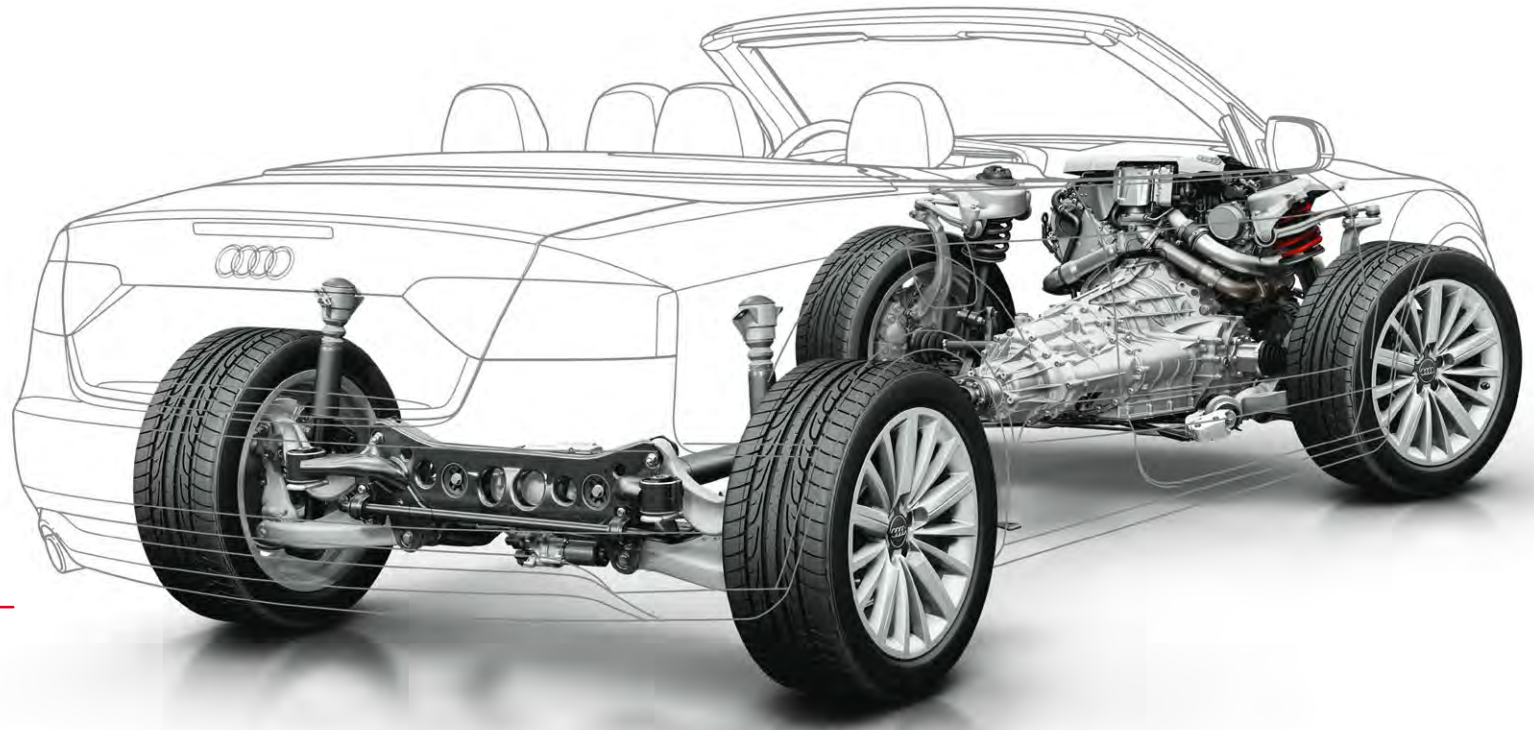

### Dampers and Springs

The linear, high-strength steel springs rest on both the structure of the body and the trapezoidal arms. The two-sleeve gas pressure dampers at all four wheels are tuned for maximum comfort and dynamic handling. This translates to confidence-inspiring handling and control.

### Audi Servotronic® Steering

Servotronic® is speed-dependent power steering in which the amount of power assist provided is dictated by road speed, providing even more comfort and convenience for the driver. The amount of power assist is greatest at low speeds, making it easier to maneuver the car. At higher speeds, an electronic-sensing system gradually reduces the level of power assist, creating a tighter, more dynamic steering feel.

To further enhance handling and ride comfort, significant attention to detail has been paid to suppressing vibrations at the attachment points along the steering column. The result is a nearly 100 percent reduction in steering wheel vibration, offering the driver smoothness at virtually any speed.

### Audi Drive Select

With 27 available vehicle handling and performance combinations, Audi drive select is another example of Audi progressive technology.

Whether you prefer the smooth, luxurious ride of Comfort mode or the more direct and firmer responses of Dynamic mode, Audi drive select allows you to tailor the vehicle to your liking. Beginning with three preset vehicle configurations, Audi drive select manages the adaptive suspension,

dynamic steering, transmission shift characteristics and throttle response according to the selected mode: Comfort, Auto or Dynamic.

Adding to the versatility of Audi drive select, the Individual mode manages 27 personalized variations, essentially allowing the driver to configure the vehicle's driving dynamics according to his or her precise preferences.

# A5 Cabriolet Premium



## A5 Cabriolet Premium

<sup>1</sup> **Leather-wrapped, three-spoke, multifunction steering wheel** | The leather-wrapped, three-spoke design has a sporty look and feel. The multifunction steering wheel provides easy access to Bluetooth\*-enabled phone, audio volume and seek functions.

<sup>2</sup> **Acoustic top** | The fully automatic, electro-hydraulic soft top features a heated glass window and thermal insulation fully suitable for winter use. The thick roof fabric and joining technique between the hood and outer fabric provide superior interior acoustics and exterior sound damping as well as LED map lights for rear passengers.

<sup>3</sup> **Split folding 50/50 rear seatbacks** | Rear seats can be folded together or individually for increased flexibility and storage options. When the rear seats are folded, access to the trunk is available from the interior, creating a convenient pass-through. When unfolded, the rear seats comfortably accommodate two adults.

\* **Power front seats with driver lumbar support** | The power front seats allow the driver and passenger to electronically adjust the seats' forward/backward position, height, angle of seat cushion and seatback and the driver's lumbar support.

\* **Audi concert radio with SIRIUS® Satellite Radio** | This stereo system integrates 180 watts of power, an SD card slot, MP3 capability, a CD player and auxiliary input for easy access to a variety of music devices. Aside from exceptional sound quality, the system also features the Radio Data System (RDS), which displays several types of FM radio information as well as SIRIUS® Satellite Radio information.

\* **Automatic climate control** | The climate control system allows the driver and passengers to enjoy an ideal level of heating or cooling via the center console. A light sensor on the dashboard adjusts the system based on the sun's intensity.

\* **Power-adjustable, heated exterior mirrors with integrated LED turn signals** | Powerful and efficient LED turn indicator lamps are artfully incorporated into the sculpted mirror housing, complementing the modern and fluid design of the vehicle. The exterior mirrors are electronically adjustable and heated to help prevent fogging.

Features listed are standard on the Premium model unless otherwise noted.

+ FEATURE NOT SHOWN

## A5 Cabriolet Premium Plus

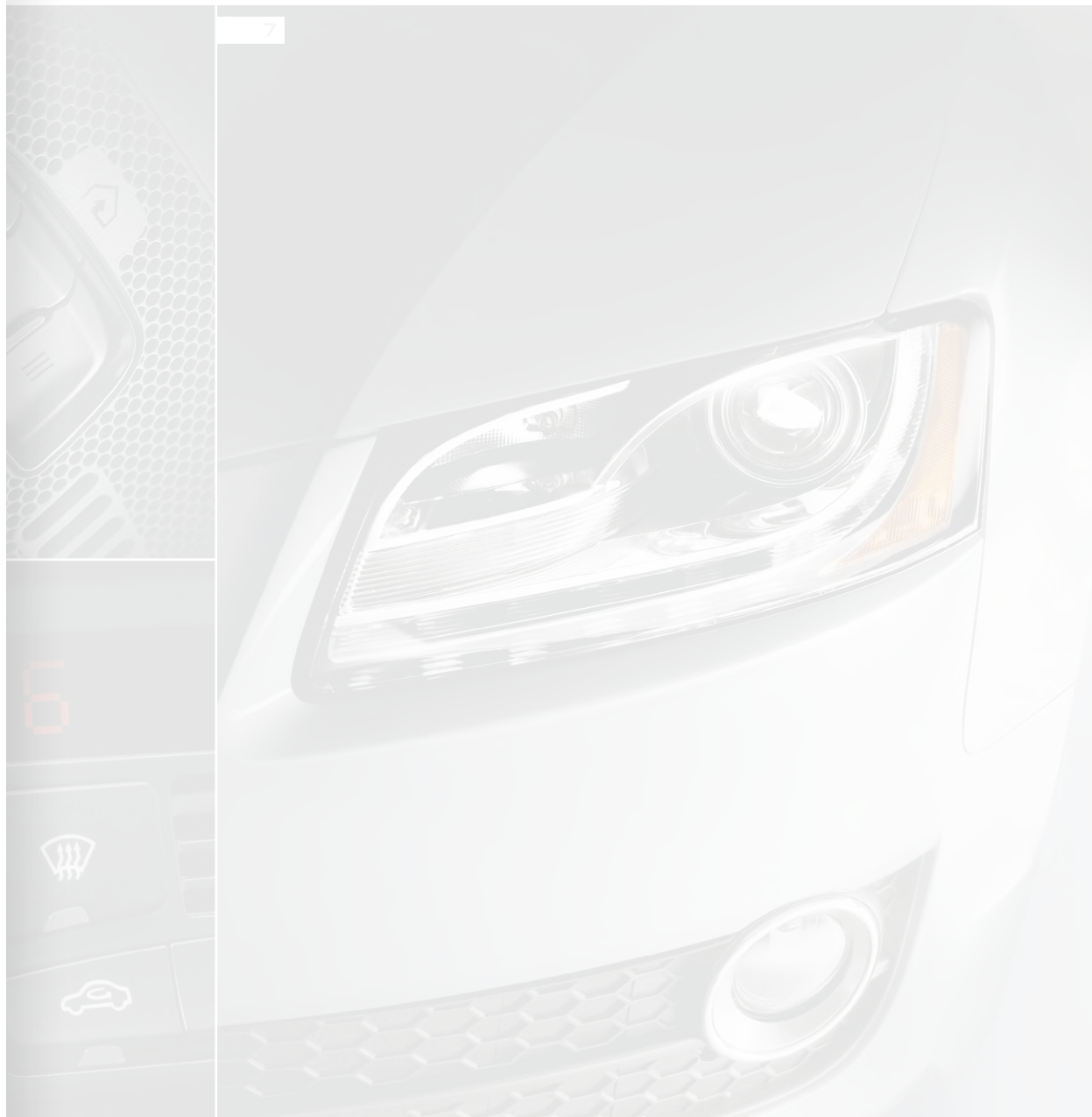

## A5 Cabriolet Premium



## A5 Cabriolet Premium Plus

- 4 LED taillights** | LED lights are superior to conventional bulbs, thanks to faster activation speeds and bright light emissions. In addition, they can last an entire vehicle lifetime and consume up to 50 percent less energy while adding a signature look to your Audi.
- 5 HomeLink®** | HomeLink® is integrated into the overhead controls and uses a simple three-button system to control garage doors, gates and even lights in your home.
- 6 Heated front seats** | With a convenient touch of a button, the multilevel seat-heating system warms the entire surface of the seat.
- 7 Audi xenon plus headlights with LED daytime running lights** | The signature LED daytime running lights and high-intensity headlights not only add a distinct look to the vehicle, they also improve visibility while using half of the energy of conventional bulbs.
- \* Audi music interface** | This connective technology offers intelligent integration with the iPod® and iPhone®. Any iPod Generation 4 and higher may be connected through the glove box, providing full iPod controls on the MMI® screen. This feature allows connection of a USB flash drive or a conventional auxiliary audio input as well.
- \* 18" 15-spoke wheels with 245/40 all-season tires** | The elegant 18" wheels make a sophisticated statement. Paired with all-season tires, you're assured of reliable year-round performance in a variety of conditions.
- \* Auto-dimming interior mirror with compass** | The rearview mirror with automatic dimming recognizes glaringly bright beams behind the car and darkens the mirror automatically. An electronic control unit varies the darkening effect quickly and continuously according to actual ambient light conditions. Vehicle direction is digitally displayed through a digital compass in the corner of the mirror.
- \* Three-zone automatic climate control** | The driver, front passenger and rear passenger can select and control their desired level of heating or cooling via the center console. A light sensor on the dashboard adjusts the system based on the sun's intensity.
- \* Rain/light sensor** | As an enhanced level of convenience and safety, an embedded sensor detects the level of light and automatically turns on the headlights if needed. The rain sensor offers the same convenience in wet conditions by automatically adjusting the rate of the wiper sweep to the rainfall.
- \* Bluetooth® mobile phone preparation** | The advanced technology of the Audi A5 Cabriolet allows you to conveniently access your Bluetooth®-enabled phone's features via the MMI operating system, allowing for easy, intuitive hands-free communication. For specific compatibility and operation instructions, refer to [audiusa.com/bluetooth](http://audiusa.com/bluetooth) or contact your local Audi dealer for the latest listing of compatible phones.

Features listed are standard on the Premium Plus model unless otherwise noted.

+ FEATURE NOT SHOWN



A5 Cabriolet Prestige

1



2



3



4



## A5 Cabriolet Prestige

## A5 Cabriolet Packages

<sup>1</sup> **Audi MMI® Navigation plus** | Audi MMI® Navigation plus features a 7" full-color LCD screen and MMI control logic. The A5 Cabriolet comes equipped with the latest generation of MMI, powered by a 40-GB hard drive and an NVIDIA® processor to enhance graphics. This generation MMI offers a color driver information system, real-time traffic, 3D topography graphics that include the buildings in many cities, and the crystal clear digital AM and FM sound of HD Radio™ Technology with over 1,000 new stations.

<sup>2</sup> **Bang & Olufsen® Sound System** | The 14 speakers and 505 digitally amplified watts with surround sound reproduction fill the interior of the vehicle with crisp, premium sound. Microphone-based noise compensation ensures optimum sound under varying road conditions and speeds.

<sup>3</sup> **Audi advanced key** | With this advanced keyless entry system, your vehicle can be locked or unlocked and started without removing the key from a pocket or purse. When the key is present, doors can be unlocked, the steering wheel can be released and the vehicle can be turned on without inserting the key into the ignition.

<sup>4</sup> **Auto-dimming exterior mirrors** | The side exterior mirrors recognize bright lights behind the car and darken the mirror glass automatically.

\* **Audi parking system with rearview camera** | This safety-enhancing system integrates a rearview camera for real-time viewing of the rear parking area while rear ultrasonic parking sensors measure the distance to the nearest object and audibly warn you when the distance becomes unsafe.

\* **Driver memory** | At the touch of a button, your driver seat position and side view mirror setting positions are set to your desired levels. This feature stores up to two driver settings.

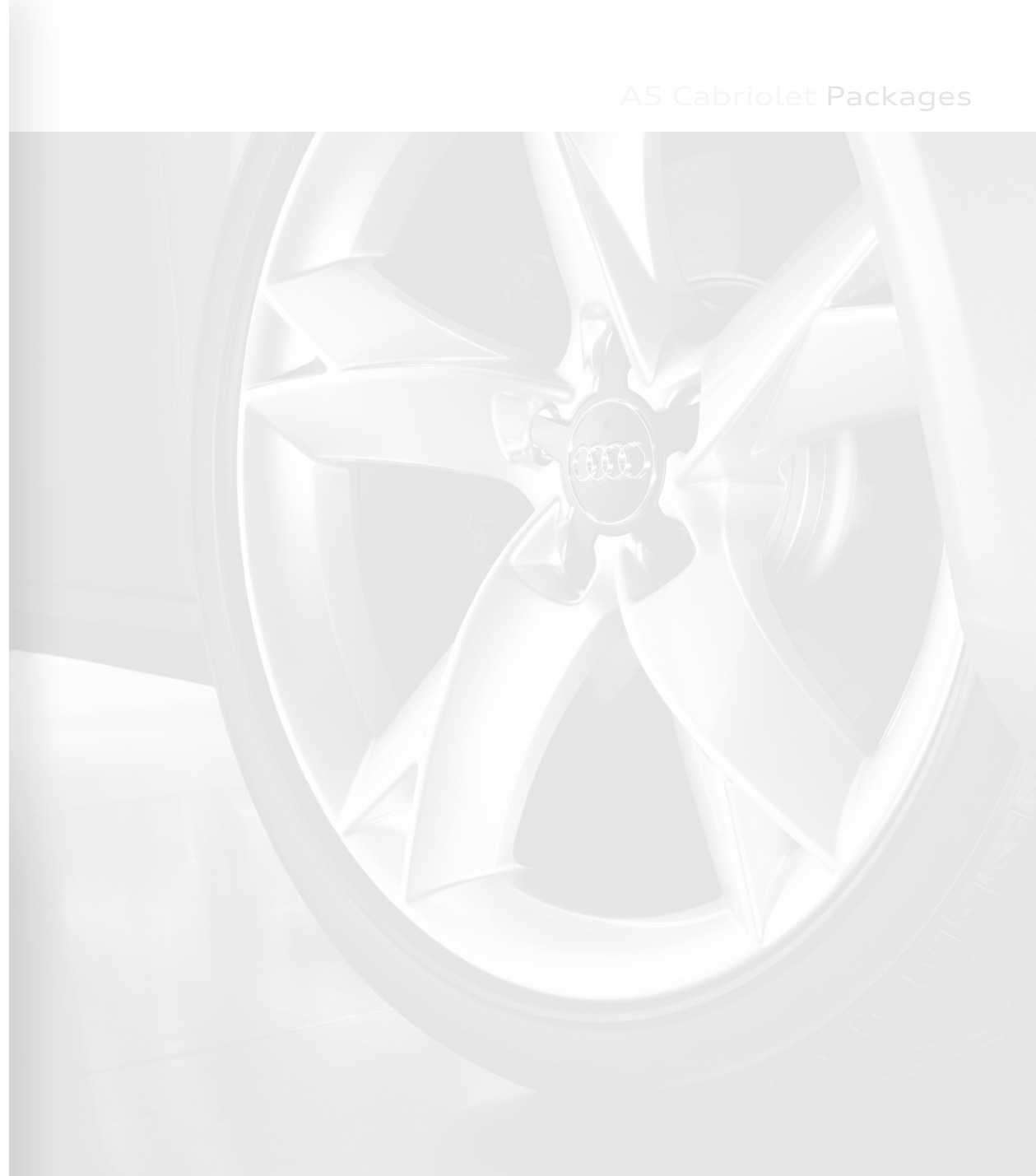

Features listed are standard on the Prestige model unless otherwise noted.

+ FEATURE NOT SHOWN

## A5 Cabriolet Prestige

1

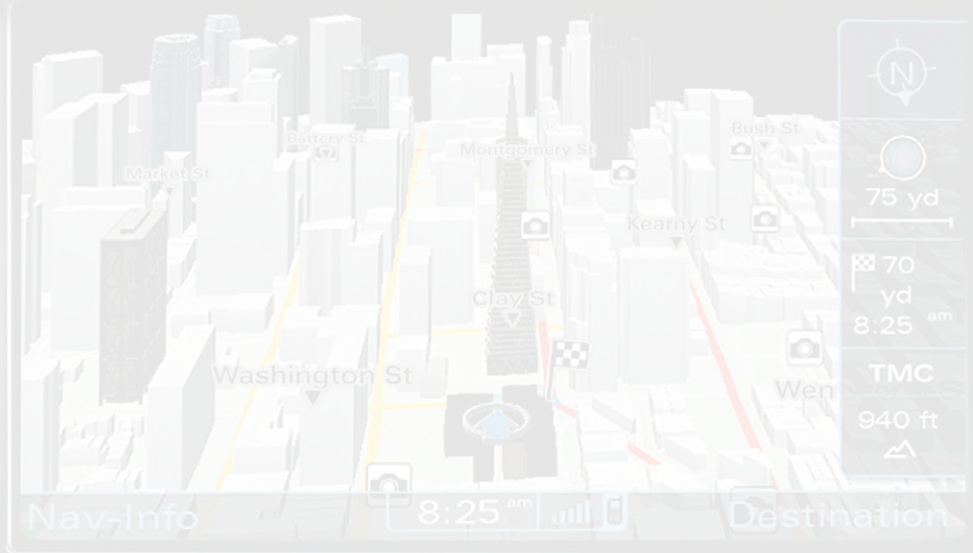

2



## A5 Cabriolet Packages

**S line® Package** | The exterior S line® features of the A5 Cabriolet include 19" S line five-Y-spoke wheels with superior handling 255/35 summer performance tires. Sport suspension is included to help improve driving dynamics. Exterior trim elements include the iconic Singleframe® grille, side valances, S line specific front and rear bumpers, and badging. Inside, elements include Brushed Aluminum doorsills with S line badging and elegant Brushed Aluminum decorative inlays extending across the center console and doors. The S line designation extends to the three-spoke, leather-wrapped steering wheel featuring special perforated leather, S line badge and shift paddles. Also included are S line sport seats with leather and perforated Alcantara® seat inserts. [Prestige only]

**Comfort Package** | The heated front seatbacks and cushions can be set to one of six settings. Should you require cooling, you can select ventilation mode to circulate air through perforations in the seats for increased comfort and airflow. Additionally, the A5 Cabriolet offers a head-level heating system extending the top-down season by circulating heat at neck level through the vents located at the top of the front seats. [Premium Plus and Prestige only]

**19" Sport Package** | For more performance-oriented handling characteristics, the 19" Sport Package includes a specially tuned, firmer suspension and sport seats that offer greater lateral support. The 19" sport design wheels have a bold, aggressive design and come equipped with 255/35 summer performance tires. Also equipped with the Sport Package are shift paddles allowing effortless, race-inspired gear shifting so you can keep your hands on the three-spoke steering wheel. [Premium Plus and Prestige only]

**Audi MMI® Navigation plus Package** | The Audi MMI® Navigation plus Package features a 7" full-color LCD screen and MMI control logic. The A5 Cabriolet comes equipped with the latest generation of MMI, powered by a 40-GB hard drive and an NVIDIA® processor to enhance graphics. This generation MMI offers a color driver information system, real-time traffic, navigation and telephone functions. Additionally, it offers 3D topography graphics that include the buildings in many cities and the crystal clear digital AM and FM sound of HD Radio™ Technology with over 1,000 new stations. Also included is the Audi parking system with a rearview camera for real-time viewing of the parking area with rear ultrasonic parking sensors measuring the distance to the nearest object and audibly warning you when the distance becomes unsafe. [Premium Plus only]

**Bluetooth® and HomeLink® Package** | The advanced technology of the Audi A5 Cabriolet allows you to conveniently access your Bluetooth®-enabled phone's features via the MMI operating system, allowing for easy, intuitive hands-free communication. For specific compatibility and operation instructions, refer to [audiusa.com/bluetooth](http://audiusa.com/bluetooth) or contact your local Audi dealer for the latest listing of compatible phones. HomeLink® is integrated into the overhead controls and uses a simple three-button system to control garage doors, gates and even lights in your home. [Premium only]

\* See page 49 for important safety information regarding summer performance tires.



A5 Cabriolet Options



## A5 Cabriolet Options

- Audi drive select** | Exclusive to Audi, this system provides advanced control of the vehicle's adaptive suspension, dynamic steering, transmission shift characteristics and engine response. The system offers 27 distinct driving configurations, allowing drivers to configure vehicle drive characteristics exactly to their liking with their choice of Comfort, Auto, Dynamic or Individual settings. [Prestige only]
- Genuine Milano leather seats** | This special soft leather is luxurious and offers added comfort for both the driver and passengers. [Premium Plus and Prestige only]
- Audi side assist** | Active at speeds over 19 MPH, Audi side assist monitors blind spot areas and fast-approaching vehicles at a range of 150 ft. When a vehicle is present within the monitored area, the system warns you via LED lights in the exterior mirrors. [Prestige only]
- Audi music interface** | This connective technology offers intelligent integration with the iPod® and iPhone®. Any iPod Generation 4 and higher may be connected through the glove box, providing full iPod controls on the MMI® screen. This feature allows connection of a USB flash drive or a conventional auxiliary audio input as well. [Premium only]
- Wood decorative inlays** | The genuine wood decorative inlays on the center console and door panels add a refined touch of luxury to the vehicle's interior. Available in Dark Brown Walnut or Nutmeg Laurel.
- Bang & Olufsen® Sound System** | The 14 speakers and 505 digitally amplified watts with surround sound reproduction fill the interior of the vehicle with crisp, premium sound. Microphone-based noise compensation ensures optimum sound under varying road conditions and speeds. [Premium Plus only]
- Heated front seats** | With a convenient touch of a button, the multilevel seat heating system warms the entire surface of the seat. [Premium only]
- Audi adaptive cruise control** | This system enhances conventional cruise control by monitoring the distance to the vehicle ahead via radar sensors. The system automatically reduces or resumes speed to maintain the safe distance selected by the driver. [Prestige only]

+ FEATURE NOT SHOWN

## S5 Cabriolet Premium Plus



## A5 Cabriolet Options

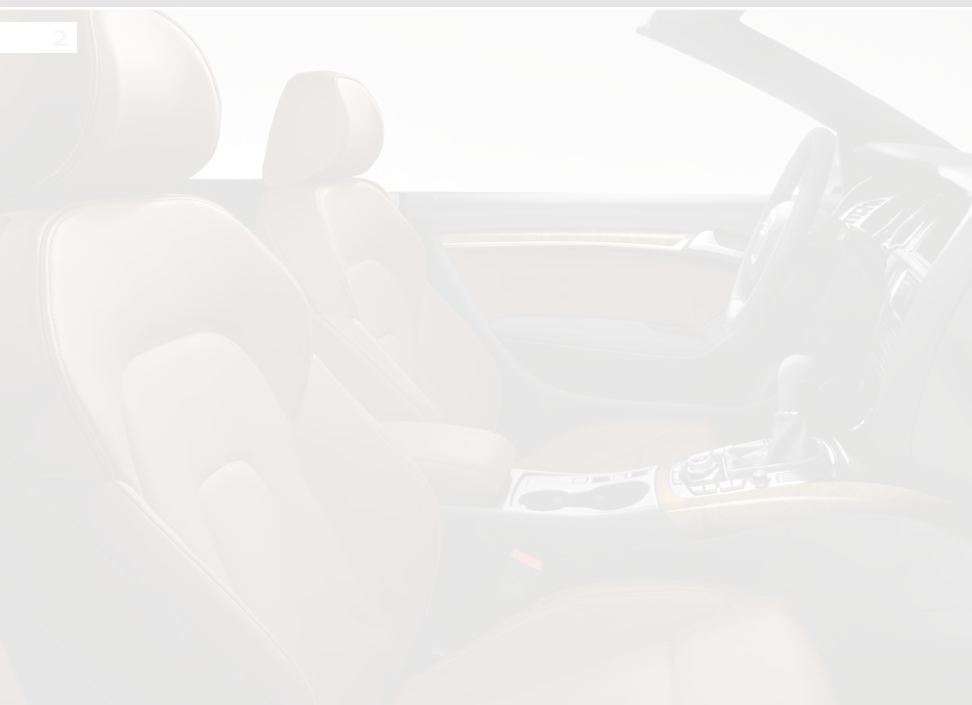

## S5 Cabriolet Premium Plus

**6 S5 Cabriolet Sport Seats** | The sport seats offer greater lateral support thanks to more prominent side bolsters and extendable thigh supports. The seat functions include electric lumbar support and integrated head restraints. With standard Silk Nappa leather, the S5 Cabriolet sport seats add a distinctive performance-oriented look and feel. Add the stylish contrast stitching, and the look is further enhanced.

**7 Leather-wrapped, three-spoke, multifunction steering wheel** | The leather-wrapped, three-spoke design has a sporty look and feel with Aluminum Optic shift paddles. The S5 Cabriolet multifunction steering wheel provides easy access to Bluetooth®-enabled phone, audio volume and seek functions.

**8 Power-adjustable, heated S exterior mirrors with integrated LED turn signals** | Powerful and efficient LED turn indicator lamps are artfully incorporated into the sculpted Aluminum Optic mirror housing, complementing the modern and fluid design of the vehicle. The exterior mirrors are electronically adjustable and heated to help prevent fogging.

**9 Dual exhaust with quad tailpipes** | This performance exhaust system features exclusive quad oval tailpipes, which create a rich exhaust note and leave no doubt to the power contained under the hood of the S5 Cabriolet.

**\* Audi concert radio with SIRIUS® Satellite Radio** | This stereo system integrates 180 watts of power, an SD card slot, MP3 capability, a CD player and auxiliary input for easy access to a variety of music devices. Aside from exceptional sound quality, the system also features the Radio Data System (RDS), which displays several types of FM radio information as well as SIRIUS® Satellite Radio information.

**\* Audi music interface** | This connective technology offers intelligent integration with the iPod® and iPhone®. Any iPod Generation 4 and higher may be connected through the glove box, providing full iPod controls on the MMI® screen. This feature allows connection of a USB flash drive or a conventional auxiliary audio input as well.

**\* Bluetooth® mobile phone preparation** | The advanced technology of the Audi S5 Cabriolet allows you to conveniently access your Bluetooth-enabled phone's features via the MMI operating system, allowing for easy, intuitive hands-free communication. For specific compatibility and operation instructions, refer to [audiusa.com/bluetooth](http://audiusa.com/bluetooth) or contact your local Audi dealer for the latest listing of compatible phones.

**\* 19" five-parallel-spoke design wheels with 255/35 summer performance tires\*** | The track-inspired 19" wheels with summer performance tires offer excellent handling.

Features listed are standard on the Premium Plus model unless otherwise noted.  
\* See page 49 for important safety information regarding summer performance tires.

**+ FEATURE NOT SHOWN**

S5 Cabriolet Premium Plus



S5 Cabriolet Prestige



## S5 Cabriolet Prestige

- 1. Audi advanced key** | With this advanced keyless entry system, your vehicle can be locked or unlocked and started without removing the key from a pocket or purse. When the key is present, doors can be unlocked, the steering wheel can be released and the vehicle can be turned on without inserting the key into the ignition.
  - 2. Audi MMI® Navigation plus** | Audi MMI® Navigation plus features a 7" full-color LCD screen and MMI control logic. The S5 Cabriolet comes equipped with the latest generation of MMI, powered by a 40-GB hard drive and an NVIDIA® processor to enhance graphics. This generation MMI offers a color driver information system, real-time traffic, 3D topography graphics that include the buildings in many cities, and the crystal clear digital AM and FM sound of HD Radio™ Technology with over 1,000 new stations.
  - 3. Bang & Olufsen® Sound System** | The 14 speakers and 505 digitally amplified watts with surround sound reproduction fill the interior of the vehicle with crisp, premium sound. Microphone-based noise compensation ensures optimum sound under varying road conditions and speeds.
- \* **Audi parking system with rearview camera** | This safety-enhancing system integrates a rearview camera for real-time viewing of the rear parking area while rear ultrasonic parking sensors measure the distance to the nearest object and audibly warns you when the distance becomes unsafe.
- \* **Auto-dimming exterior mirrors** | The side exterior mirrors recognize bright lights behind the car and darken the mirror glass automatically.
- \* **Driver memory** | At the touch of a button, your driver seat position and side view mirror positions are set to your desired levels. This feature stores up to two driver settings.

Features listed are standard on the Prestige model unless otherwise noted.

\* **FEATURE NOT SHOWN**

## S5 Cabriolet Packages



## S5 Cabriolet Prestige

1



2

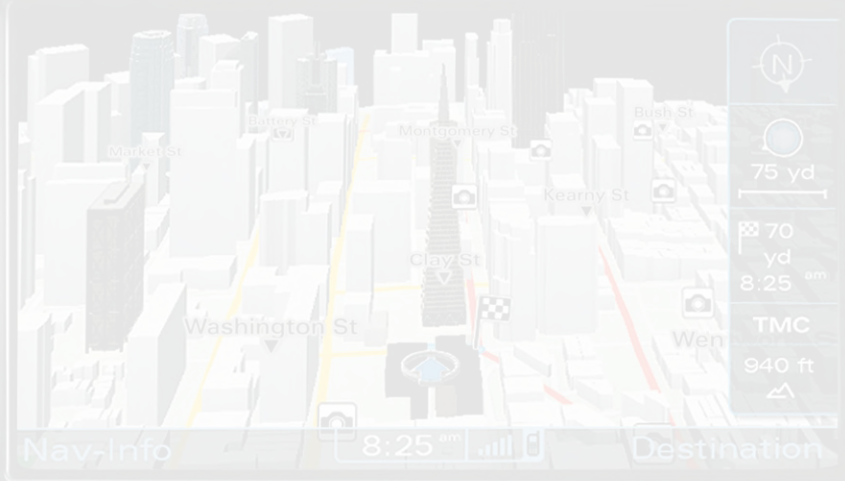

3



## S5 Cabriolet Packages

- 4 Audi Drive Select Package** | Audi drive select controls the vehicle's adaptive suspension, dynamic steering, transmission shift characteristics and engine response. The system offers your Audi four distinct driver configurations: Comfort, Auto, Dynamic and Individual. On the S5 Cabriolet, the package also includes quattro® with Sport Rear Differential, which dynamically varies torque between the rear wheels for even greater cornering agility. [Prestige only]
- 5 Comfort Package** | The heated front seatbacks and cushions can be set to one of six settings. Should you require cooling, you can select a ventilation mode to circulate air through perforations in the seats for increased comfort and airflow. Additionally, the S5 Cabriolet offers a head-level heating system extending the top-down season by circulating heat at neck level through the vents located at the top of the front seats.
- Audi MMI® Navigation plus Package** | The Audi MMI® Navigation plus Package features a 7" full-color LCD screen and MMI control logic. The S5 Cabriolet comes equipped with the latest generation of MMI, powered by a 40-GB hard drive and an NVIDIA® processor to enhance graphics. This generation MMI offers a color driver information system, real-time traffic, navigation and telephone functions. Additionally, it offers 3D topography graphics that include the buildings in many cities and the crystal clear digital AM and FM sound of HD Radio™ Technology with over 1,000 new stations. Also included is the Audi parking system with a rearview camera for real-time viewing of the parking area with rear ultrasonic parking sensors measuring the distance to the nearest object and audibly warning you when the distance becomes unsafe. [Premium Plus only]

+ FEATURE NOT SHOWN



S5 Cabriolet Options



## S5 Cabriolet Options

**1. Audi side assist** | Active at speeds over 19 MPH, Audi side assist monitors blind spot areas and fast-approaching vehicles at a range of 150 ft. When a vehicle is present within the monitored area, the system warns you via LED lights in the exterior mirrors. [Prestige only]

**2. Audi adaptive cruise control** | This system enhances conventional cruise control by monitoring the distance to the vehicle ahead via radar sensors. The system automatically reduces or resumes speed to maintain the safe distance selected by the driver. [Prestige only]

**3. Stainless Steel inlays** | The distinctive Stainless Steel inlays are composed of woven stainless steel threads and are furnished across the doors. The center console comes with the Piano Black inlay.

**4. Carbon Fiber inlays** | Exclusive to Audi S models, the sophisticated Carbon Fiber inlays add a performance-ready feel to the interior.

**+ Bang & Olufsen® Sound System** | The 14 speakers and 505 digitally amplified watts with surround sound reproduction fill the interior of the vehicle with crisp, premium sound. Microphone-based noise compensation ensures optimum sound under varying road conditions and speeds. [Premium Plus only]

**+ quattro® with Sport Rear Differential** | Continuing a legacy of all-wheel drive performance, quattro® with Sport Rear Differential dynamically varies torque between the rear wheels for enhanced cornering agility and traction performance.

**+ 19" five-tri-spoke wheels with 255/35 summer performance tires\*** | The high-performance look of the 19" wheels is complemented by the summer performance tires that offer enhanced handling.

\* See page 49 for important safety information regarding summer performance tires.

**+ FEATURE NOT SHOWN**

## A5 S5 Cabriolet Accessories



## S5 Cabriolet Options



## A5 S5 Cabriolet Accessories

- 5 Rear diffuser with blade insert** | A clean, aero-look enhancement for the rear aspect of the A5 Cabriolet. [A5 Cabriolet only]
- 6 Side sills** | The side sills exude dynamic, sport-inspired design. They are featured on the left and right side of the vehicle. [A5 Cabriolet only]
- 7 18" five-arm, hollow-spoke design wheels** | These unmistakably designed alloy wheels feature the latest hollow-spoke technology for a lower-weight wheel, which helps deliver improved driving dynamics and comfort.
- 8 19" 15-spoke design wheels** | An impressive, clean, drop-center, deep-dish design makes this 15-spoke wheel the perfect complement to your A5 Cabriolet.
- + Front spoiler with blade insert** | This exclusive Audi-designed styling component creates a dynamic lowered stance with the front spoiler and blade. [A5 Cabriolet only]
- + Rubber floor mats** | These trim-profile, embossed rubber mats help extend the life of your carpet by providing all-around protection from dirt and debris. Available in black, in sets of two for front and/or rear.
- + Storage cover** | Protect your Audi from the elements with this lightweight, easy-to-use cover. The cover is made of Stormshield® material and is custom cut for your A5 and S5 Cabriolet. Includes a storage bag.

See your local Audi dealer for the complete selection of Genuine Audi Accessories.

+ FEATURE NOT SHOWN



# A5 Cabriolet Wheels

1



2



3



## A5 Cabriolet Wheels

**1. 18" ten-spoke wheels with 245/40 all-season tires** | These standout 18" wheels offer sophistication matched with a distinctive ten-spoke style, enhancing the overall exterior of the Audi A5 Cabriolet. [Premium only]

**2. 18" 15-spoke wheels with 245/40 all-season tires** | The elegant 18" wheels make a sophisticated statement. Paired with all-season tires, you're assured of reliable year-round performance in a variety of conditions. [Premium Plus and Prestige only]

**3. 19" five-Y-spoke design wheels with 255/35 summer performance tires\*** | A work of art, these wheels make a dramatic and sporty statement, regardless of whether they are moving or motionless. [Option on Premium Plus and Prestige only]



## S5 Cabriolet Wheels



\*Summer performance tires are designed for optimum performance and handling in warm climates. They are not suitable for cold, snowy or icy weather conditions. If you drive under those circumstances, you should equip your vehicle with all-season or winter tires, which offer better traction under those conditions. We suggest you use the recommended winter or all-season tires specified for your car or their equivalent. These summer performance tires also have a lower aspect ratio that aids performance and handling. However, in order to avoid tire, rim or vehicle damage, it is important that the inflation pressure is regularly checked and maintained at recommended levels. Serious wheel and tire damage may occur if the vehicle is operated on rough or damaged road surfaces, or upon encountering road debris or obstacles. Please also remember in making your selection that, while these tires deliver responsive handling, they may ride less comfortably and make more noise than other choices. Finally, these tires may wear more quickly than other choices. For more information on all of these topics, please consult the owner's manual, your local dealer or call 1-800-FOR-AUDI.

## A5 Cabriolet Wheels

1



2



3



## S5 Cabriolet Wheels

**4 19" five-parallel-spoke design wheels with 255/35 summer performance tires\*** | The 19" five-parallel-spoke design wheel option is impressive in its stance and design. The wheels come equipped with summer performance tires, which provide improved driving dynamics and superior handling and performance. [Premium Plus and Prestige only]

**5 19" five-tri-spoke wheels with 255/35 summer performance tires\*** | The boldly distinctive openness of the five-tri-spoke alloy wheels with summer performance tires makes a sporty statement. [Option on Premium Plus and Prestige only]

\* Summer performance tires are designed for optimum performance and handling in warm climates. They are not suitable for cold, snowy or icy weather conditions. If you drive under those circumstances, you should equip your vehicle with all-season or winter tires, which offer better traction under those conditions. We suggest you use the recommended winter or all-season tires specified for your car or their equivalent. These summer performance tires also have a lower aspect ratio that aids performance and handling. However, in order to avoid tire, rim or vehicle damage, it is important that the inflation pressure is regularly checked and maintained at recommended levels. Serious wheel and tire damage may occur if the vehicle is operated on rough or damaged road surfaces, or upon encountering road debris or obstacles. Please also remember in making your selection that, while these tires deliver responsive handling, they may ride less comfortably and make more noise than other choices. Finally, these tires may wear more quickly than other choices. For more information on all of these topics, please consult the owner's manual, your local dealer or call 1-800-FOR-AUDI.

## S5 Cabriolet Wheels

4



5



# A5 Cabriolet Interior Seating | Decorative Inlay

BLACK LEATHER or MILANO LEATHER | ALUMINUM HOLOGRAM INLAY



## DECORATIVE INLAY OPTIONS

- ALUMINUM HOLOGRAM INLAY  
*[Standard]*
- DARK BROWN WALNUT WOOD INLAY  
*[Option]*
- NUTMEG LAUREL WOOD INLAY  
*[Option]*
- BRUSHED ALUMINUM INLAY  
*[S line\* only]*

LIGHT GRAY LEATHER or MILANO LEATHER | DARK BROWN WALNUT WOOD INLAY\*



CARDAMOM BEIGE LEATHER OR MILANO LEATHER | NUTMEG LAUREL WOOD INLAY\*



BLACK LEATHER/PERFORATED ALCANTARA\* | BRUSHED ALUMINUM INLAY [S line® only]



CINNAMON BROWN MILANO LEATHER | NUTMEG LAUREL WOOD INLAY\*

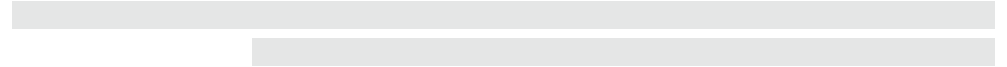

# S5 Cabriolet Interior Seating | Decorative Inlay

BLACK MILANO LEATHER | BRUSHED ALUMINUM INLAY



## DECORATIVE INLAY OPTIONS

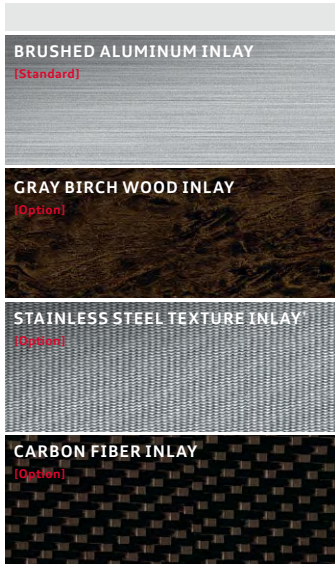

TUSCAN BROWN MILANO LEATHER | GRAY BIRCH WOOD INLAY\*



\* Optional inlay shown  
\* Includes Piano Black inlay on center console

BLACK/SPECTRAL SILVER SILK NAPPA LEATHER | BRUSHED ALUMINUM INLAY\*



BLACK/TUSCAN BROWN SILK NAPPA LEATHER | GRAY BIRCH WOOD INLAY\*



BLACK/MAGMA RED SILK NAPPA LEATHER | STAINLESS STEEL TEXTURE INLAY\*\*



BLACK SILK NAPPA LEATHER | CARBON FIBER INLAY\*\*



# A5 S5 Cabriolet Make yours.

## Roof Colors

- 1 | Black
- 2 | Brown
- 3 | Red

- 1 | Black\*
- 2 | Light Gray\* [A5 only]
- 3 | Cardamom Beige\* [A5 only]
- 4 | Cinnamon Brown [A5 only]
- 5 | Tuscan Brown [S5 only]
- 6 | Black/Spectral Silver [S5 only]
- 7 | Black/Magma Red [S5 only]
- 8 | Black/Tuscan Brown [S5 only]

\* Available in Milano leather, leather/perforated Alcantara; Silk Nappa leather and Silk Nappa leather/Alcantara\*

† Available in leather and Milano leather

\* Additional charge



A5 Teak Brown METALLIC†



A5 Arum Beige METALLIC†



A5 S5 Brilliant Black

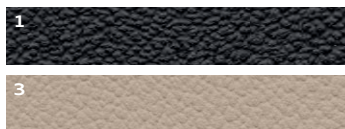



A5 S5 Quartz Gray METALLIC



A5 S5 Brilliant Red



A5 S5 Ice Silver

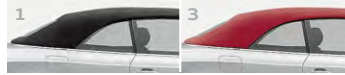

A5 S5 Meteor Gray PEARL EFFECT



A5 S5 Deep Sea Blue PEARL EFFECT

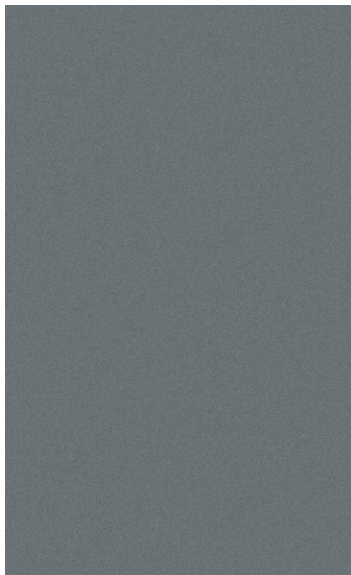



A5 S5 Ibis White



S5 Phantom Black PEARL EFFECT\*



S5 Sprint Blue PEARL EFFECT\*

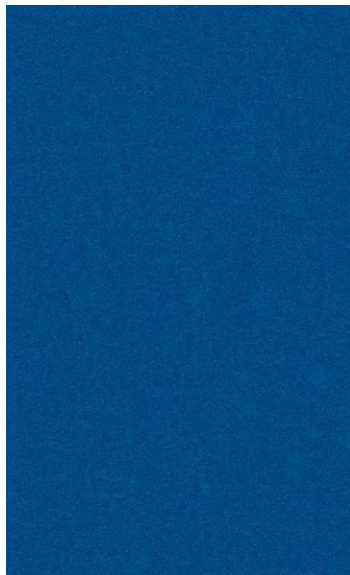
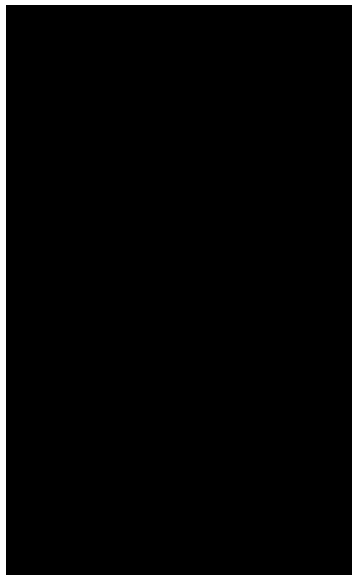
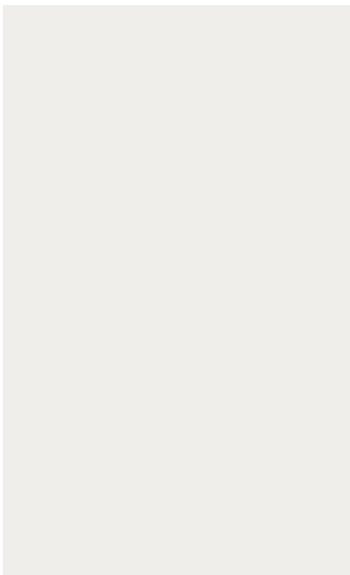

# A5 S5 Cabriolet Specifications | Configurations

Chassis   Technical	A5	S5
Five-link front suspension with upper and lower control arms, stabilizer bar and individual, gas-charged coil springs/shock absorbers	S	S
Independent trapezoidal-link rear suspension with rigid subframe, stabilizer bar and individual, gas-charged coil springs/shock absorbers	S	S
Servotronic® speed-sensitive power steering – varies assistance based on vehicle speed	S	S
quattro® permanent all-wheel drive system utilizing torque-sensing center differential – 40:60 rear-biased torque split	0	S
quattro with Sport Rear Differential permanent all-wheel drive system utilizing torque-sensing center differential – 40:60 rear-biased torque split and variable torque application between rear wheels	-	0
Sport suspension calibration	0	-
S5 sport suspension calibration	-	S
Seven-speed S tronic® transmission – dual-clutch	-	S
Eight-speed Tiptronic® automatic transmission	0	-
Multitronic® Continuously Variable Transmission (CVT)	S	-
Audi acoustic folding roof – folds at speeds up to 30 MPH	S	S

Safety   Security	A5	S5
Driver and front passenger advanced dual-stage airbag <sup>1</sup> supplemental restraints	S	S
Driver and front passenger seat-mounted side head and thorax airbag <sup>1</sup> supplemental restraints	S	S
Front passenger occupant detection for airbag <sup>1</sup> supplemental restraints	S	S
Front three-point safety belts with automatic pre-tension and force limiters	S	S
Rear three-point safety belts with belt force limiters for outboard passenger seating positions	S	S
Safety belt reminder for driver and front passenger	S	S
Motorized safety belt presenter for easy access	S	S
Lower anchors for child seats in rear seats	S	S
Pinch protection for front windows	S	S
Central locking system with selective unlock feature	S	S
Impact protection – including reinforced high-strength steel/aluminum cross members, reinforced bumpers and rigid occupant cell	S	S
Rear roll bars that deploy automatically	S	S
Tire pressure monitoring system	S	S
Electronic Stabilization Program (ESP®)	S	S
Anti-lock Brake System (ABS) with Electronic Brake-pressure Distribution (EBD)	S	S
Brake assist – a system that automatically senses emergency braking and applies maximum power boost to reduce overall stopping distance	S	S
Front ventilated disc brakes	S	S
Rear disc brakes	S	-
Rear ventilated disc brakes	-	S
Anti-theft vehicle alarm system with blinking theft-deterrent light	S	S

Interior	A5	S5
Leather-wrapped, three-spoke, multifunction, sport steering wheel with controls for audio volume, Bluetooth™ phone and audio seek functions	S	S
Shift paddles on steering wheel	O	S
Tilt and telescopic manually adjustable steering column	S	S
Storage nets in backs of front seats	S	S
Dual front sun visors with lighted vanity mirror for driver and front passenger	S	S
Leather seating surfaces	S	-
Leather seats with perforated Alcantara® inserts	O	-
Silk Nappa leather upholstery	-	S
Eight-way power driver seat with four-way power lumbar adjustment	S	-
Eight-way power passenger seat	S	-
Eight-way power sport front seats with four-way power lumbar adjustment	O	-
Eight-way power S5 sport seats with integrated head restraints, extendable thigh support and four-way power lumbar adjustment	-	S
Eight-way power climate control seats with perforated Milano leather	O	O
Memory for driver seat adjustment and exterior mirrors	O	O
Six-step heated front seats	O	S
Split folding 50/50 rear seatback	S	S
Backlit instrument cluster with brightness control	S	S
Automatic climate control	S	-
Three-zone automatic climate control	O	S
Power windows with one-touch up/down operation and pinch protection	S	S
Removable cargo floor for access to spare	S	S
Auto-dimming interior mirror with compass	O	S

Exterior	A5	S5
LED turn signals in mirror housings	S	S
Auto-dimming exterior mirrors	O	O
Dual exhaust pipes [one left, one right]	S	-
S quad exhaust pipes [two left, two right]	-	S
Halogen headlights with integrated high and low beams	S	-
Audi xenon plus headlights with automatic self-leveling and integrated LED daytime running lights	O	S
LED taillights	O	S
Two front foglights located in lower front bumper	S	S
Heated windshield wiper nozzles	S	S
Power-adjustable heated side mirrors [body color on A5; Aluminum Optic on S5]	S	S
Metallic/pearl effect paint	O	O

Infotainment   Technology	A5	S5
Audi concert system with single CD player with MP3 playback capability, AM/FM radio, auxiliary input jack, SD card slot for MP3 files and speed-dependent volume control	S	S
SIRIUS® Satellite Radio with three-month trial subscription	S	S
Audi Sound System, 180 watts with ten speakers, including a subwoofer and center fill speaker	S	S
Bang & Olufsen® Sound System – 505-watt audio system with 14 speakers and ten-channel amplifier	O	O
Audi Navigation plus <sup>1</sup> with 3rd generation MMI <sup>2</sup> , hard-drive navigation, one DVD player, HD Radio™ Technology, two SD card slots for MP3 files, and SIRIUS Satellite Radio	O	O
Audi music interface with iPod® and iPhone® integration	O	S
Bluetooth <sup>3</sup> preparation for mobile phone	O	S
Driver information system – trip computer, outside temperature, radio/telephone/navigation display, Auto-Check, open door/deck lid indicator	S	S
Audi advanced key – keyless start, stop and entry	O	O
Electronic cruise control	S	S
Adaptive cruise control maintains preset distance from vehicle in front	O	O
Automatic light switch controlled by light sensor, “coming home” and “leaving home” functions	O	S
Rain sensor for automatic windshield wipers	O	S
Power central locking system with radio-operated key fob remote control for doors and deck lid	S	S
HomeLink® universal remote	O	S
Rear parking sensors with rearview camera	O	O

-	Not Available	O	Option	S	Standard
---	---------------	---	--------	---	----------

The table above represents the standard equipment on the A5 Cabriolet Premium model and S5 Cabriolet Premium Plus model. Many popular options are combined and available on the Premium Plus and Prestige models. Please see the package contents in this brochure for complete details.

\* Airbags are supplemental restraints only and will not deploy under all crash circumstances. Always use safety belts and seat children in the rear, using restraint systems appropriate for their size and age.

<sup>†</sup> Your Audi vehicle is equipped with a phone preparation utilizing Bluetooth interface to enable hands-free functionality [compatible mobile phones sold separately]. You will need a Bluetooth-enabled mobile phone in order to utilize this function. Not all Bluetooth-enabled mobile phone models are compatible with Audi phone preparation. Visit [audiusa.com/bluetooth](http://audiusa.com/bluetooth), or contact your local Audi dealer for the latest listing of compatible phones. Audi recommends use of the Audi phone cradle [sold separately] with your mobile phone while operating this vehicle.

<sup>‡</sup> Audi Navigation plus depends on signals from the worldwide Global Positioning Satellite network. The vehicle's electrical system, and existing wireless and satellite technologies, must be available and operating properly for the system to function. The system is designed to provide you with suggested routes in locating addresses, destination and other points of interest. Changes in street names, construction zones, traffic flow, points of interest and other road system changes are beyond the control of Audi of America, Inc. Complete detailed mapping of lanes, roads, streets, toll roads, highways, etc., is not possible, therefore you may encounter discrepancies between the mapping and your actual location. Please rely on your individual judgement in determining whether or not to follow a suggested Audi Navigation plus route. Periodically, the mapping is updated, and a new DVD will be required in order to maintain the latest navigation information available to us. These will be available for purchase from time to time at an additional cost. Consult your dealer or call 1-800-FOR-AUDI for details.

## A5 Cabriolet Model Configurations

2.0 TFSI® with Multitronic® CVT and FrontTrak® front-wheel drive  
 2.0 TFSI with eight-speed Tiptronic® transmission and quattro® all-wheel drive

### Power and Performance

+ 2.0 liter turbocharged with intercooler, DOHC in-line four-cylinder gasoline engine with FSI® direct injection and Audi valvelift system

+ Horsepower: 211hp @ 4300-6000 RPM

+ Torque: 258 lb-ft. @ 1500-4200 RPM

+ 0-60 MPH in seconds – Multitronic: 7.5, Tiptronic: 6.7

+ Top track speed\*: 130 MPH

+ Fuel economy estimate, city/highway†:  
 Multitronic: 22/30 MPG; Tiptronic: 21/29 MPG‡

## S5 Cabriolet Model Configurations

3.0 TFSI with seven-speed, dual-clutch S tronic® transmission and quattro all-wheel drive

### Power and Performance

+ 3.0 liter supercharged, DOHC V6 gasoline engine with dual intercoolers, FSI direct injection and variable valve timing

+ Horsepower: 333hp @ 5500-7000 RPM

+ Torque: 325 lb-ft. @ 2900-5300 RPM

+ 0-60 MPH in seconds: 5.1

+ Top track speed†: 155 MPH

+ Fuel economy estimate, city/highway‡:  
 S tronic: 17/26 MPG

## A5 S5 Cabriolet Dimensions

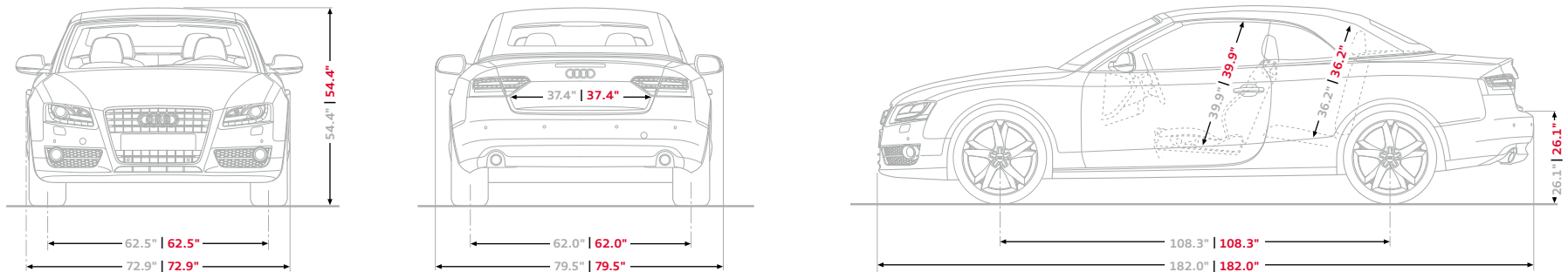

\* Top track speed for A5 Cabriolet electronically limited to 130 MPH in the U.S. Obey all local speed and traffic laws. † EPA fuel economy estimates. Your mileage will vary.

‡ Top track speed for S5 Cabriolet electronically limited to 155 MPH in the U.S. Obey all local speed and traffic laws. § Based on 2010 EPA estimates.

2011 | A5 S5

Audi of America

[Audiusa.com](http://Audiusa.com)

[Facebook.com/Audi](https://Facebook.com/Audi)

BR-A5Cab-10-1500US

Note: A word about this brochure. Audi of America, Inc. believes the specifications in this brochure to be correct at the time of printing. However, specifications, standard equipment, options, and colors are subject to change without notice. Some equipment may be unavailable when your vehicle is built. Please ask your dealer for advice concerning current availability of standard and optional equipment, and your dealer will verify that your vehicle will include the equipment you ordered. Vehicles in this brochure are shown with optional equipment. See your dealer for complete details on the new-vehicle limited warranty, twelve-year limited warranty against corrosion perforation, and Audi 24/7 Roadside Assistance. [Roadside assistance coverage provided by Road America in the U.S. Certain conditions apply; see your dealer for details.] Tires supplied by various manufacturers. "Truth in Engineering" is a registered trademark of Audi of America, Inc. "Audi," "quattro," all model names, "Multitronic," "FrontTrak," "MMI," "FSI," "TFSI," "S tronic," "Sideguard," "Singleframe," the Singleframe grille design, and the four rings logo are registered trademarks of AUDI AG. "Servotronic" is a registered trademark of the AM General Corporation. "Tiptronic" is a registered trademark of Dr. Ing h.c. F. Porsche AG. "Alcantara" is a registered trademark of Alcantara S.P.A. "HomeLink" is a registered trademark of Prince Corporation, Holland, Michigan. "SIRIUS" is a registered trademark of SIRIUS Satellite Radio, Inc. "Bluetooth" is a registered trademark of Bluetooth SIG. "iPod" and "iPhone" are registered trademarks of Apple Computer, Inc. HD Radio™ and the HD Radio logo are proprietary trademarks of iBiquity Digital Corporation.

©2010 Audi of America, Inc.