

2010 BMW
3 Series
Sports Wagon



328i
328i xDrive

The Ultimate
Driving Machine®



BMW 3 SERIES SPORTS WAGON.
FAST RELIEF FOR THOSE WHO NEED THEIR SPACE.

Contents

The 2010 3 Series Sports Wagon

03 | 17 Exterior

18 | 25 Interior

Technology

26 | 27 BMW EfficientDynamics

28 | 29 Engine

30 | 31 Exterior

32 | 33 Active Cruise Control | Xenon Adaptive Headlights

34 | 35 xDrive | Dynamic Stability Control

36 | 37 iDrive | Navigation | Telematics | BMW Assist™

38 | 39 Safety features

Equipment

40 | 43 Paints | Upholsteries | Interior trims | Combinations

44 | 45 Selection examples

46 | 55 Standard and Optional equipment

56 Safety features and technology illustrations

57 | 62 Equipment charts

63 | 64 Technical data

65 BMW Accessories

66 | 67 BMW Services

The BMW 3 Series Sports Wagon blends driving passion and practicality in equal amounts. Propelling you from Point A to B: a smooth inline six-cylinder engine, with vast reserves of pure BMW muscle at the ready. Updated exterior cues, a plush, refined interior with oversize Panoramic moonroof, and exciting enhancements transform any drive into an extraordinary experience. With its generous amount of versatile storage space, you, your passengers and your cargo always arrive in style. The 3 Series Sports Wagon: a great idea from a company committed to ideas.

 bmwusa.com

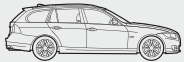
	328i shown with the following equipment:
	Engine: 24-valve, 3.0-liter, inline six-cylinder Wheels: Star Spoke (Style 286) light alloy Exterior color: Space Gray Metallic Upholstery: Saddle Brown/Black Dakota Leather
BMW 328i Sports Wagon	Optional Equipment: Park Distance Control, roof rails, Sport and Cold Weather Packages

For more information on paints, upholstery and interior trims, see pages 40-43.



Rising up to meet the challenges of the road.
The BMW 3 Series Sports Wagon.



The 3 Series Sports Wagon seats five comfortably with plenty of space left for luggage and other items. But the 3 Series is first and foremost a BMW – so the most important seat is still the one behind the wheel. Under the hood of both 328i and 328i xDrive models: BMW's 3.0-liter inline six-cylinder Valvetronic engine. With a rewarding 230 hp and 200 lb-ft of torque on tap, it satisfies even the most demanding driving needs. The 328i xDrive also features the iron grip of the xDrive intelligent all-wheel-drive system, for the added confidence of optimal traction on nearly any road, in virtually any conditions. The 3 Series Sports Wagon: a most powerful way to answer the call of the road.

Be prepared for anything.
Behind the wheel, you already are.

With impressive power must come the tools to help you control it. The 3 Series Sports Wagon, with its array of innovative driving systems, makes it easy to maintain your confidence. A firm yet responsive connection to the road is essential; when the 3 Series Sports Wagon detects oversteer, understeer or skidding, Dynamic Stability Control (DSC) automatically activates precision braking and modulates power to help optimize vehicle handling. In the 328i xDrive, the power of BMW's intelligent all-wheel-drive system boosts your confidence even further. An advanced traction system designed for the most adverse driving conditions, xDrive transfers torque to the wheels with grip, helping to keep you safely on course. Wherever you go, the 3 Series has you covered.



Leave your expectations at home.

From every angle, a smooth interpretation of power.

From headlights to taillights, the Sports Wagon's chiseled contours reflect the athletic nature of the BMW 3 Series. Character lines trace the graceful slope of the hood, directing your eyes down to the BMW kidney grille with its bold, sleek form, flanked by the signature quad headlights with their distinctive Corona headlight-rings that can double as Daytime Running Lights. The line ends, then curves back up at the muscular front air dam with its jewel-like foglights. The side flows back, its complex contours reflecting the nuances of unique paint colors such as Tasman Green Metallic and Blue Water Metallic. And at the rear, grace and practicality meet in the handsome, thoughtfully designed tailgate. Elegant, dynamic, functional: all integral elements of the 3 Series Sports Wagon's personality.





Harness the 3 Series Sports Wagon's spirited 230-hp engine with a transmission that's equally impressive. Choose one of two smooth-shifting 6-speeds: either the silken manual or the STEPTRONIC automatic with Adaptive Transmission Control. And for a rewarding, racing-inspired drive, steering wheel-mounted paddle shifters are included when you combine the automatic transmission and Sport Package or M Sport Package. What else would you expect from a BMW with "Sports" in its name?

For details on the availability of standard and optional features, please refer to the Standard equipment | Optional equipment charts at the back of this brochure.



Balanced squarely at the forefront of superior driving dynamics.

BMW's stance on handling has always been firm: provide the most thrilling and precise connection to the road. The 328i Sports Wagon advances this concept with innovative axle technologies. In the front: increased stiffness through the extensive use of lightweight all-aluminum components, such as tension rods, transverse control arms, swivel bearings and axle supports. In the rear: five extremely rigid, individual control arms for both rear wheels, as well as a large supporting base for track and camber. This innovative suspension delivers the solid, sporty handling that complements the 3 Series' copious power. And the vehicle's near-perfect 50/50 weight distribution offers strikingly well-balanced road feel, with responsive characteristics unmatched by any competitor.



Fiercely protective of its owner.

Building on BMW's distinguished safety record, the 3 Series Sports Wagon's broad array of active and passive safety features gives you peace of mind. Crisp handling, fade-resistant braking and potent muscle help you avoid potential hazards; technologies like Xenon Adaptive Headlights help you spot them sooner. But should the unavoidable occur, the 3 Series Sports Wagon's rigid steel body and deformable crush zones help dissipate the impact of a crash, while its leading-edge system of sensors, safety-belt pretensioners, airbags and front-seat Active Head Restraints help protect you and your passengers.

For details on the availability of standard and optional features, please refer to the Standard equipment | Optional equipment charts at the back of this brochure.



The 3 Series Sports Wagon.
Everything in its right place.



Take the wheel – and take control of the road.

The cockpit of the 3 Series is a finely honed command center that's as practical as it is plush. The driver-oriented dashboard is the perfect example of how technology can enhance the driving experience. Take the leather-wrapped multi-function steering wheel. Designed for a firm grip, it places useful controls at your fingertips, so you can adjust the audio or make calls without taking your hands from the wheel – or eyes from the road. Paddle shifters and steering wheel heating add more comfort and joy to every drive. Beyond the steering wheel, all controls are within instinctive reach; every dial and gauge can be easily checked at a glance. A high-resolution 8.8" control display is included with the Navigation and iDrive system. Designed for greater convenience when accessing or customizing various information and entertainment functions, iDrive includes direct-selection keys for specific menus, and six programmable memory keys that give one-touch access to your most frequently used functions. From this vantage point, virtually every driving wish is granted.

For details on the availability of standard and optional features, please refer to the Standard equipment | Optional equipment charts at the back of this brochure.



Because every trip should sound as amazing as it feels.

BMW believes in creating your own personal space. That's why you can configure the 3 Series Sports Wagon interior in a broad palette of colors and trims. Settle back in the eight-way adjustable front seats, then create an equally rewarding environment for your ears. Listen to your favorite music on the Logic7 audio system. With 13 upgraded speakers, advanced sound processing and surround sound, you're in the middle of the music. An auxiliary input inside the center armrest storage compartment allows you to connect digital music players and other peripherals. Add the iPod® and USB adaptor in the console and you can control your music through the stereo controls. SIRIUS Satellite Radio offers over 100 channels of entertainment and commercial-free music nationwide; HD Radio™ receives free digital broadcasts with CD-quality sound, | multicast| FM stations, and innovative data services.

Interior features:	
Upholstery:	Saddle Brown/Black Dakota Leather
Trim:	Aluminum
Optional features:	Logic7 sound system Sport Package Navigation system

For details on the availability of standard and optional features, please refer to the Standard equipment | Optional equipment charts at the back of this brochure.



An accommodating interior,
front and back, with room to spare.

In the rear cabin of the 3 Series, you'll find much more than just ample head- and legroom. The same level of exquisite craftsmanship found in front is repeated in the back, which is designed to accommodate three passengers in comfort. Lower the center armrest, with its hidden dual cupholders, for supportive comfort for two, or flip down the 60/40 split-fold rear seats. Rear-seat passengers can also keep their cool ☹️ and privacy ☹️ with rear manual side-window shades.

For details on the availability of standard and optional features, please refer to the Standard equipment | Optional equipment charts at the back of this brochure.



No compromises.
That includes passenger and cargo space.

Cargo space: the area where the 3 Series Sports Wagon really earns its keep. Need to stow groceries, suitcases, sports equipment? The 3 Series Sports Wagon's spacious layout and smart design let you fit it all in with ease. Another convenience: 60/40 split-folding seats for greater storage versatility, so you can pack longer items, like skis. Loading a few, small objects? Don't bother lifting the tailgate; the rear window opens separately, for quick access. Thanks to the standard run-flats, there's no need for a spare tire – so BMW transformed the unused space under the cargo floor into a handy hidden storage area, complete with dividers and a tool kit. Whether it's a trip to the grocery store or a cross-country excursion, this is cargo space that goes the distance.

This is how much has gone in.

At BMW, we create dynamic vehicles that thrill you with quick acceleration, predictable handling and unshakable control. We are also busy finding ways to sustain this level of performance while incorporating innovative fuels and technologies to help preserve the environment. This is what we refer to as EfficientDynamics. This goal has led to the visionary CleanEnergy hydrogen-powered engine, which is currently used in the emission-free BMW Hydrogen 7 Sedan. BMW Advanced Diesel with BluePerformance, which offers diesel power with quick acceleration, increased fuel efficiency and reduced emissions, was introduced to the U.S. in select models in 2009. In fact, every BMW on the road today comes standard with technology that boosts performance while simultaneously reducing fuel consumption and CO₂ emissions.

Valvetronic

Instead of using a traditional throttle, Valvetronic technology in the 328i and 328i xDrive lets the engine breathe more easily by varying the lift height of the valves to regulate air intake. The result: improved cold starts, smoother running, and a significant drop in fuel consumption. Using revolutionary technology such as this, BMW has improved its overall average fuel economy more than any other manufacturer.

Aerodynamics

The more smoothly that air flows over a vehicle, the more efficiently it can operate. All BMWs are designed for a low coefficient of aerodynamic drag, which translates into quicker acceleration, more stable handling, quieter operation and greater fuel efficiency. A BMW's integrated front spoilers reduce the amount of air flowing underneath, minimizing front-end lift. This allows a BMW to hug the road at higher speeds for excellent stability.

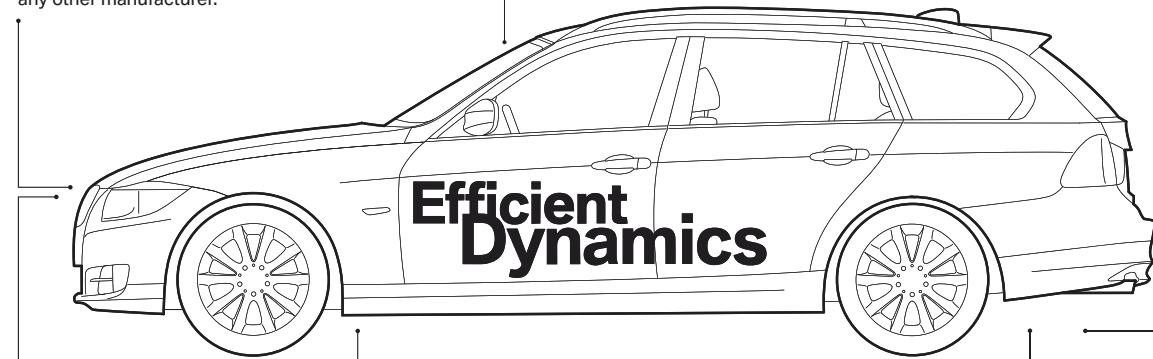

Double-VANOS

VANOS is BMW's valve timing system that can steplessly vary the points in the combustion cycle when valves open and close. Double-VANOS refers to the fact that it operates on both the intake and exhaust camshafts. Electronically controlled in response to engine speed, load and temperature, VANOS reduces emissions, and enhances low- to medium-speed torque, as well as fuel efficiency.

Efficient transmissions

The 3 Series Sports Wagons channel their power through one of two 6-speed transmissions: a smooth-shifting manual, and an equally fuel-efficient STEPTRONIC automatic.

Lightweight construction

Our engineers use lightweight aluminum throughout our vehicles in the front section, for example, or for the suspension. BMW's inline six-cylinder engine is a naturally aspirated aluminum/magnesium composite the lightest in its class. Taken together, these weight savings lead to lower fuel consumption and better axle load distribution for more agility especially in curves.

And this is what comes out.

BMW models have low CO₂ emissions today. But that's just for starters. We're carrying on our research in the quest to bring you greater driving pleasure, with fewer emissions and decreased fuel consumption.

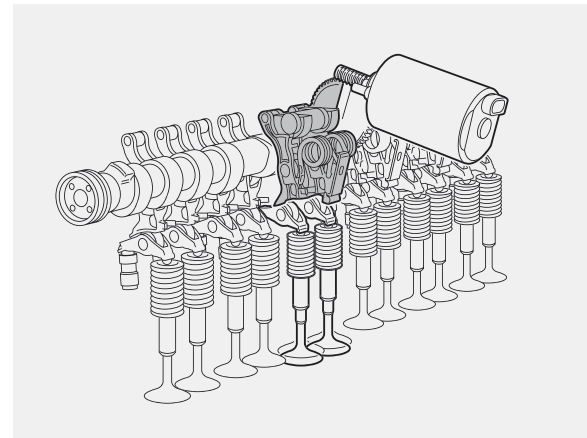

BMW's Valvetronic system reduces pumping losses in the engine, especially under part-load conditions, thereby reducing fuel consumption.

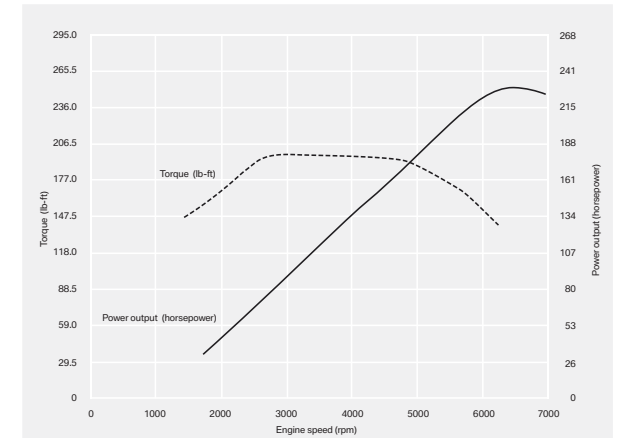

Portrait of an engineering masterpiece: the 3.0-liter engine pours on the power and quickly develops maximum torque, which continues without fading over a large rpm range so you enjoy smooth, powerful acceleration at virtually any legal speed.

At BMW, power always comes special delivery.

Engines are our passion. That's why a BMW engine doesn't just deliver power and performance, but does so very smoothly and efficiently. It's this refinement that makes our powerplants unique. So it comes as no surprise that we are not the only ones to call our engines refined; they have been receiving accolades and awards from the automotive press for years.

Hit the accelerator of the 328i Sports Wagon, and in 6.5 seconds¹ you're sailing past 60 mph. Its inline six generates 230 hp at 6500 rpm. And with 200 lb-ft of torque at 2750 rpm, the power pours on early and strong, and continues throughout the powerband. The result is more power at low rpms and improved efficiency.

The lightweight composite magnesium/aluminum engine block adds to the spirited acceleration and nimble handling. The camshafts are hydroformed to create a hollow structure that reduces weight and improves strength; even the exhaust manifold is made of a lightweight alloy. The result is one of the lightest six-cylinder engines of its size.

Advanced Valvetronic technology lets this powerplant breathe better, resulting in greater power, higher torque, quicker engine response, a smoother idle, and enhanced fuel efficiency. And no matter what type of driving you do high way cruising, hauling goods, or hugging a winding mountain curve BMW's Double-VANOS technology selects the best intake and exhaust valve timings to keep everything running smoothly, with lightning-quick acceleration on command and instant power delivery.

Both the 328i and 328i xDrive channel their power through one of two 6-speed transmissions a smooth-shifting manual, or STEPTRONIC automatic. Combine the automatic transmission and Sport Package or M Sport Package, and you will automatically receive steering wheel-mounted paddle shifters for smooth, clutch-free shifting.

¹ 328i Sports Wagon with manual transmission; 7.1 seconds with STEPTRONIC automatic. 328i xDrive with manual transmission, 7.1 seconds; 7.3 seconds with STEPTRONIC automatic. BMW AG test results. BMW urges you to obey all posted speed laws and always wear safety belts.



A true sensory experience – from the vehicle's point of view. The 3 Series Sports Wagon features a wide range of innovative technologies that make driving easier, and connect you to the road in uncanny ways. From Navigation system features that make finding your way more fun, to intelligent cruise control technologies that “see” upcoming traffic, the 3 Series Sports Wagon's features and options shine under any circumstances – so you can concentrate on the drive.

For details on the availability of standard and optional features, please refer to the Standard equipment | Optional equipment charts at the back of this brochure.

The Active Cruise Control system uses radar sensors in front to gauge the distance and speed of vehicles ahead of you.

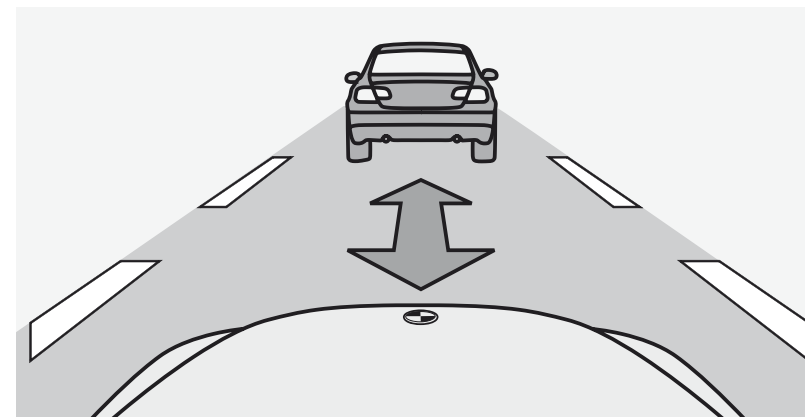
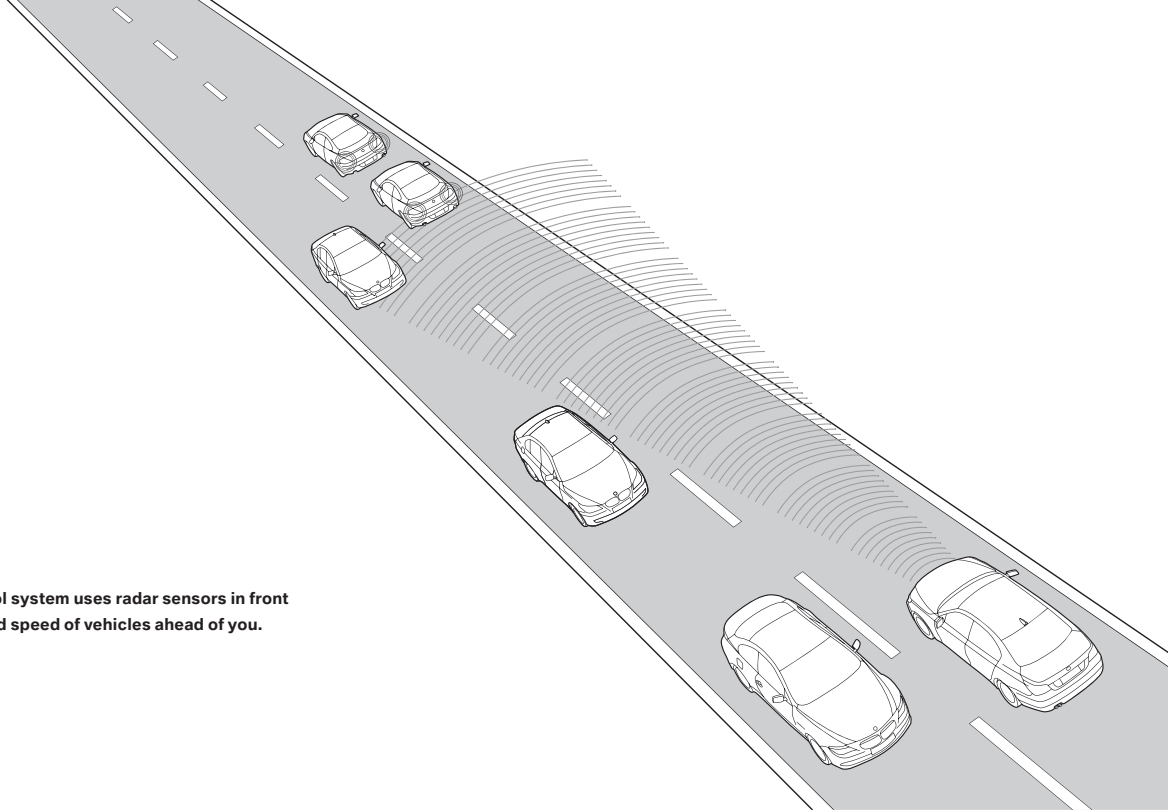

Using radar measurements, Active Cruise Control automatically maintains a preset speed and distance between your vehicle and the one ahead in both traffic and highway driving.

Active Cruise Control: another name for highway stress control.

BMW gives you many ways to enjoy driving. First, you can keep your right foot firmly in control, alternating between the accelerator and the brake pedal. Second, on long stretches of highway with light traffic, you can give your right foot a rest by activating standard Dynamic Cruise Control. It keeps you at your desired preset speed, not only on level stretches, but by accelerating uphill and braking downhill.

Then there's driving in traffic. Here's where your BMW can actually help relieve stress — that is, if it's equipped with Active Cruise Control. This feature adjusts your speed automatically, decelerating when you approach a slower vehicle, and then accelerating back up to your preset speed when the coast is clear.

Using radar sensors that scan the area in front of the vehicle, Active Cruise Control gauges the speed of vehicles traveling ahead of you. As you get closer, a vehicle ahead icon lights up. Your BMW then automatically adjusts its speed, even braking when necessary, in order to maintain the safe following distance you've preselected. When the slower traffic ahead clears, your BMW automatically resumes your previously set cruising speed. It's one more way BMW helps maintain the joy of driving — even in traffic.

Note: Active Cruise Control is not a substitute for the driver's own responsibility in adjusting speed and otherwise controlling the vehicle. After evaluating road, traffic and visibility conditions, the driver must decide whether and how the system is used.

For details on the availability of standard and optional features, please refer to the Standard equipment | Optional equipment charts at the back of this brochure.

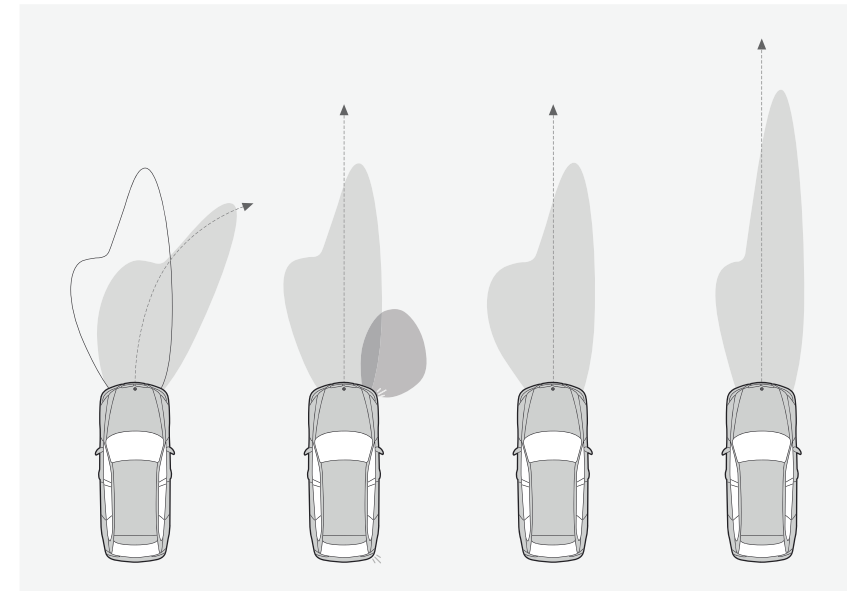

Adaptive Headlights create cones of light that follow the direction of the headlights.

Cornering Lights illuminate the side of the road when turning, helping to reveal obstacles, cyclists and pedestrians.

Xenon low beams provide improved illumination of the road, while Corona headlight-rings act as Daytime Running Lights and parking lights.

High beams — both Xenon and halogen — increase the range of visibility. The Automatic high beam feature senses approaching headlights and turns the high beams off, then on, as needed.

See nighttime driving in a new light.

The 3 Series headlights, set in chromed tubes, emphasize the Sports Wagon's sharp looks and wider stance while helping you see better in the dark. Distinctive Corona headlight-rings, which circle the low beams, function as parking lights. They can also be set to function as Daytime Running Lights, via the Advanced Vehicle & Key Memory feature. Cornering Lights direct an angled beam at each front corner when turning, at low speeds, and in reverse gear. Vertically layered turn-signal lights, like the L-shaped taillights, use LED technology for quicker, heightened visibility.

When equipped with Xenon Adaptive Headlights, the road ahead is illuminated with the near-daylight brilliance and clarity of Xenon high-intensity discharge (HID) lights, while an auto-leveling feature reduces headlight glare for oncoming drivers. The Adaptive light control feature automatically swivels the lights to follow the curves of the road, using data from on-board sensors and the steering wheel angle.

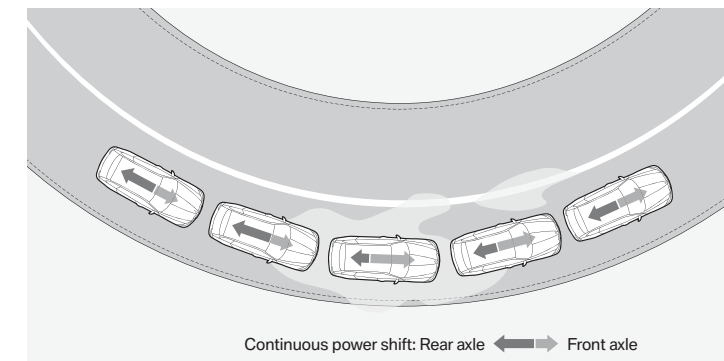

BMW's xDrive intelligent all-wheel-drive system continuously monitors the vehicle's status — rpm's, steering angle, acceleration — and when it detects wheelspin, sends the optimal amount of power to the axle with traction.

xDrive all-wheel drive: the power to master anything that crosses your path.

In the 328i xDrive Sports Wagon, xDrive intelligent all-wheel drive takes all-road traction to new heights while maintaining BMW's legendary agility. On smooth, dry roads, vehicles with xDrive have the feel of their rear-wheel-drive counterparts. But hit a wet uphill curve, for instance, and even before wheelspin can occur, the xDrive system immediately recognizes any need for a change in power distribution. Almost instantaneously, xDrive can send more torque to the front axle to enhance stability. Should one wheel or axle spin faster than the other, the brakes automatically engage, as needed, to bring all wheels back in sync.

Working in conjunction with xDrive, and standard in all 3 Series models, is the latest version of BMW's Dynamic Stability Control (DSC) system. This includes four innovative automatic braking functions. **Brake Stand-by:** If you suddenly remove your foot from the throttle, DSC anticipates that you're going to want to stop quickly. It then pre-tenses the brake calipers for quicker action when you step on the brake pedal. **Brake Drying:** When it rains, your brakes get wet and can take longer to stop the vehicle. When the sensor determines that it is raining, it reacts by periodically bringing the brake pads into contact with the rotors, just enough to eliminate the accumulated moisture and help dry them, but not enough to cause brake application. **Start-off Assistant:** When stopped on an incline, DSC prevents your vehicle from rolling backwards or forwards. It even holds your car momentarily when you release the brake to start moving again. **Brake Fade Compensation:** As your brakes heat up due to continuous or repeated braking (like when you're descending a winding mountain road), the same pedal action results in less braking power. DSC senses and compensates for this by applying the brakes with more force with the same pedal action.

Augmenting the xDrive system are Automatic Stability Control (ASC) and Dynamic Brake Control (DBC), which maximizes brake force on both axles, should the system detect that the driver wishes to brake as hard as possible. And a special Dynamic Traction Control (DTC) mode can be selected at the push of a button, allowing more wheel slip and yaw angle, providing incremental traction on slippery surfaces and snow. BMW's advanced traction and stability technology ensure that no challenge faced on the road ever goes unanswered.

For details on the availability of standard and optional features, please refer to the Standard equipment | Optional equipment charts at the back of this brochure.



When an upcoming service need is detected, your BMW automatically transmits all relevant information to your BMW Service Advisor, who then contacts you to arrange an appointment.

Select not only the fastest, but also the most interesting roads to reach your destination.

Heading for a traffic jam? **Real Time Traffic Information** lets you know in advance and recommends an alternative route.

Get into a serious accident? Your BMW automatically calls for help and communicates all relevant information.

All drivers sometimes need to stop and refuel. Let a **BMW Assist™** Concierge locate and send the address of your preferred gas station and the best local restaurant to your BMW.

Need an address or telephone number? **BMW Search™** uses Google Maps™ to find them, then your Navigation system guides you there.

Find many more ways how **BMW Assist** makes every trip you take more enjoyable.



MyInfo allows you to send business locations and street addresses to your BMW from your computer. Destinations and phone numbers can be accessed and exported to your Navigation system for immediate routing, while you can call the destination with your Bluetooth® linked phone.



BMW Search allows online access to up-to-date fuel prices, the latest weather forecasts, Bloomberg stock indices and the powerful reach of the Google Maps™ database delivered on your control display inside your vehicle.



In most large cities, **Real Time Traffic Information** makes you aware of traffic congestion before you encounter it. This feature displays and describes current local traffic information on your control display; in case of congestion, it suggests alternate routes.



BMW is the first automobile manufacturer to offer **BMW Trips**, giving you the opportunity to directly transfer personally planned trips from the Internet to your Navigation system via a USB memory stick. (Delayed availability.)

Two for the road: Navigation and BMW Assist

When you're far from home or just in the next town, it's easy to find your way with confidence and peace of mind with the convenient features and services available on your BMW.

BMW Assist Safety Plan gives you peace of mind knowing that a friendly response specialist is there to help you 24/7, at the touch of a button. Enjoy four years of a wide range of services at no additional charge. The Safety Plan includes Automatic Collision Notification, Emergency Request (SOS), TeleService, Enhanced Roadside Assistance, Door Unlock, Stolen Vehicle Recovery, Customer Relations and MyInfo.

The **BMW Assist Convenience Plan** adds personalized Directions, Traffic and Weather reports, BMW Search and Concierge services to not only recommend restaurants and hotels, but then also send the destination address and phone number right to your BMW. You can make up to four operator-assisted calls per year with Critical Calling if your cell phone is not available or its battery is discharged.



For details on the availability of standard and optional features, please refer to the Standard equipment | Optional equipment charts at the back of this brochure.



High performance when it counts: in a flash.

The advanced safety systems of the 3 Series Sports Wagon build on its impressive record.¹ Passive safety begins with the extremely rigid steel safety cage that surrounds the occupant compartment, with deformable crush tubes front and rear. In a severe crash, impact energy is absorbed and routed around the passenger cabin.

Sensors throughout the vehicle measure both the severity of the crash and the presence of occupants. After analyzing the data, the vehicle determines the best plan for deploying safety-belt pretensioners and airbags. Six airbags are on hand to help shield occupants from harm: for the driver and front passenger, there are dual-threshold, dual-stage front airbags, and seat-mounted front side airbags. In a side impact, Head Protection System (HPS)

side-curtain airbags stretch all the way from the A pillar in the front to the C pillar at the rear, helping to keep front and rear occupants' heads from hitting the side windows, and keeping debris out of the cabin.

The front seats of the 3 Series Sports Wagon include Active Head Restraints. In a rear-end impact, they quickly pivot forward, close to the backs of occupants' heads. This reduces rearward head motion, lessening the likelihood of whiplash or other head or neck injuries.

¹Insurance Institute for Highway Safety (IIHS) Top Safety Pick Silver rating, March 2006, is based in part on the 3 Series' performance in IIHS's 40-mph frontal-offset and 31-mph side-impact tests.

In the event of a severe impact, up to six airbags can deploy, and front-seat Active Head Restraints can pivot upward, to help protect front-seat occupants. In a side collision, BMW's Head Protection System (HPS) helps shield front and rear passengers' heads and torsos from impact and debris.

Please note: These pictures of airbags are for illustrative purposes only. Depending upon the type of accident, none, some or all airbags may deploy.

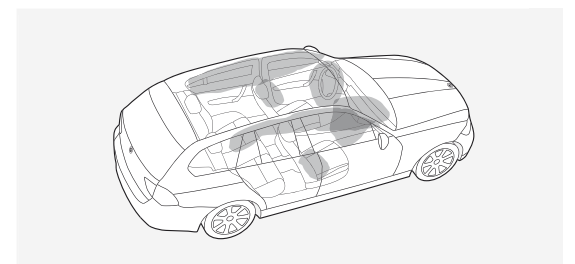

The pages in this section show available colors and materials for the BMW 3 Series Sports Wagon. Use these samples to compare paint, upholstery, trim colors and combinations. Please note that these samples are representations; they are not exact reproductions. To see the actual colors, visit your local BMW center. They will be happy to show you original samples and assist you with special requests.

bmwusa.com/byo

Exterior Paints

300 Alpine White Non-metallic

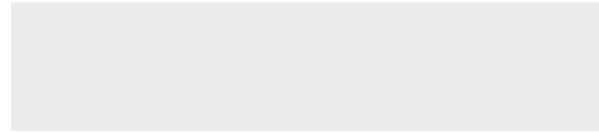

A61 Crimson Red Non-metallic



668 Jet Black Non-metallic

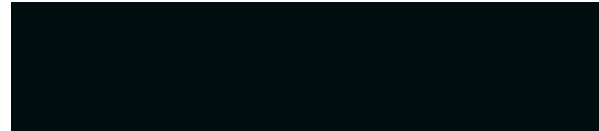

354 Titanium Silver Metallic

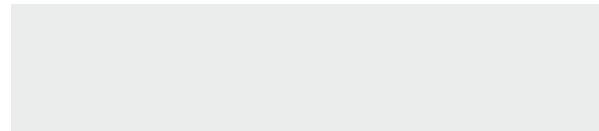

A53 Platinum Bronze Metallic



896 Blue Water Metallic



A51 Montego Blue Metallic



A35 Monaco Blue Metallic



381 Le Mans Blue Metallic (requires M Sport Package)



A39 Barbera Red Metallic



A81 Tasman Green Metallic



A52 Space Gray Metallic



475 Black Sapphire Metallic



Please refer to the Recommended color combinations chart on page 43 for details on limitations and exclusivity when selecting 3 Series Sports Wagon exterior paint colors and upholstery materials and colors.

Upholsteries

KAB4 Beige Leatherette



KASW Black Leatherette



LCAD Gray Dakota Leather



LCB4 Beige Dakota Leather

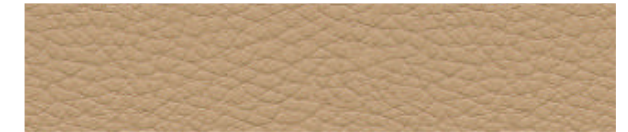

LCCX Oyster/Black Dakota Leather

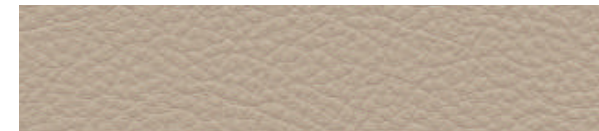

LCCZ Chestnut Brown/Black Dakota Leather

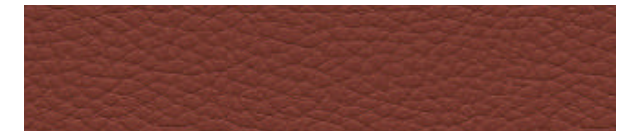

LCD3 Saddle Brown/Black Dakota Leather

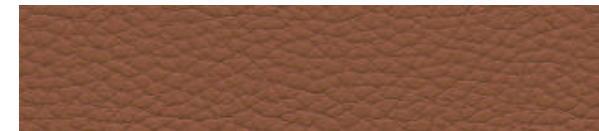

LCSW Black Dakota Leather

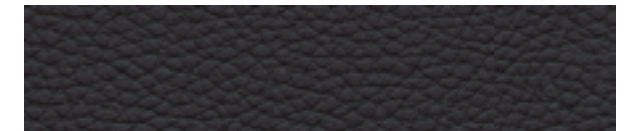

Please refer to the Recommended color combinations chart on the facing page for details on limitations and exclusivity when selecting 3 Series Sports Wagon interior trim.

Recommended color combinations

Materials	Leatherette ¹		Dakota Leather ²					
	Beige	Black	Gray	Beige	Oyster	Chestnut Brown	Saddle Brown	Black
Upholstery colors								
Exterior colors								
300 Alpine White Non-metallic ¹		●	●	●	●	●	●	●
A61 Crimson Red Non-metallic ^{1,3}		●	●	●	●			●
668 Jet Black Non-metallic ^{1,3}		●	●	●	●	●	●	●
354 Titanium Silver Metallic ⁴		●	●	●	●	●	●	●
A53 Platinum Bronze Metallic ^{3,4}		●	●	●	●			●
896 Blue Water Metallic ⁴		●	●		●	●	●	●
A51 Montego Blue Metallic ^{3,4}		●	●	●	●	●	●	●
A35 Monaco Blue Metallic ^{3,4}		●	●	●	●	●		●
381 Le Mans Blue Metallic ⁵		●	●	●	●		●	●
A39 Barbera Red Metallic ^{3,4}		●	●	●	●			●
A81 Tasman Green Metallic ^{3,4}		●	●	●	●		●	●
A52 Space Gray Metallic ⁴		●	●	●	●	●	●	●
475 Black Sapphire Metallic ⁴		●	●	●	●	●	●	●
Interior trims								
4B9 Aluminum ⁶		●	●	●	●	●	●	●
4MG Glacier Silver Aluminum ⁵		●	●	●	●	●	●	●
4AB Dark Burl Walnut Wood ¹		●	●	●	●	●	●	●
4A3 Light Burl Walnut Wood ⁶		●	●	●	●	●	●	●

¹ Standard in both models.
² Optional and included in both models with Premium Package.
³ Not available with M Sport Package.
⁴ Optional in both models.
⁵ Optional; requires M Sport Package.
⁶ No-cost option in both models.

Interior trims

□ **4B9** Aluminum



□ **4MG** Glacier Silver Aluminum (requires M Sport Package)



■ **4AB** Dark Burl Walnut Wood



□ **4A3** Light Burl Walnut Wood





City slicker.

By day, the 328i Sports Wagon in Space Gray Metallic paint means serious business. By night, it mirrors the excitement of the big city. Underscoring the drama: a sophisticated interior upholstered in supple Black Dakota Leather and brightened with Aluminum trim. If an evening at the theater is in your plans, bypass traffic jams to arrive on time with the optional Navigation system with Real Time Traffic Information. Now start the engine and let the show begin.

328i Sports Wagon shown with the following equipment:	
Exterior color:	Space Gray Metallic
Interior upholstery:	Black Dakota Leather
Interior trim:	Aluminum
Additional equipment:	Sport Package with Star Spoke (Style 286) light alloy wheels, Navigation system, Park Distance Control, roof rails



Nature lover.

Take off for your weekend retreat. You're ready to be one with nature and the 328i xDrive Sports Wagon is your surefooted travel companion. Its Blue Water Metallic exterior paint has the calming effect of sky and water; inside, the creamy Oyster/Black Dakota Leather upholstery, set off by striking Dark Burl Walnut Wood, brightens your day and lifts your spirits.

328i xDrive Sports Wagon shown with the following equipment:	
Exterior color:	Blue Water Metallic
Interior upholstery:	Oyster/Black Dakota Leather
Interior trim:	Dark Burl Walnut Wood
Additional equipment:	Optional V Spoke (Style 285) light alloy wheels, Cold Weather Package, roof rails

bmwusa.com

For details on the availability of standard and optional features, please refer to the Standard equipment | Optional equipment charts at the back of this brochure.





□ **Xenon Adaptive Headlights** provide brilliant clarity of the road ahead and to the side at night and in conditions with poor visibility. The dynamic auto-leveling feature adjusts for varying passenger and cargo loads, helping to keep headlight glare out of the eyes of oncoming drivers. BMW Adaptive Headlights provide optimum road illumination around corners, thanks to an electromechanical control system that directs the headlights into and around the bend as soon as the vehicle begins cornering. Also shown in the redesigned headlight cluster: vertically layered LED turn-signal indicators, included as standard, offer quicker, heightened visibility.



■/□ **Retractable high-intensity headlight washers** help keep lights clear of ice, mud, road salt and other coatings, for maximum road lighting and enhanced driving safety.



■ BMW's **distinctive front kidney-shaped grille** features a chrome surround with black slats.



■ **Rain sensor** measures the amount of rain. In □ intermittent □ windshield wiper mode, it automatically adjusts the wiping interval as needed. Includes **Automatic headlight control** (not shown), which activates headlights by means of a sensor that responds to darkness. The rain sensor is also integrated into the braking system as part of the Brake Drying feature.



■ **Door sill** with BMW insignia and polished chrome inlay adds a customized touch to the 3 Series Sports Wagon.



■ Convenient **lighting** features make it easy to see inside and outside the vehicle. When the door is locked, press the remote's □ lock □ button to turn on cabin lights and the illuminated door handle. When you open the door, lights shine down to illuminate the ground where you step.



■ **xDrive badges**, located next to the front wheel wells of the 328i xDrive Sports Wagon, indicate that it is an all-wheel-drive model.



□ **Star Spoke (Style 286)** light alloy wheels and **run-flat¹ performance tires**.² In front: 17 x 8.0 wheels with 225/45 tires; in back: 17 x 8.5 wheels with 255/40 tires. (Included in 328i Sport Package; optional in 328i xDrive with Sport Package).



□ **V Spoke (Style 360)** 16 x 7.0 light alloy wheels with 205/55 **run-flat¹ all-season tires**. (Standard on 328i and 328i xDrive).



□ **Multi Spoke (Style 284)** 17 x 8.0 light alloy wheels with 225/45 **run-flat¹ all-season tires**. (Included in 328i xDrive Sport Package).



□ **V Spoke (Style 285)** 17 x 8.0 light alloy wheels with 225/45 **run-flat¹ all-season tires**. (Optional on 328i/328i xDrive; not available with Sport Package or M Sport Package).

¹ Run-flat tires do not come equipped with a spare tire.

² Due to low-profile tires, please note: wheels, tires and suspension parts are more susceptible to road hazard and consequential damages. Performance tires not recommended for driving in ice and snow.



□ **Three-spoke leather-wrapped multi-function sport steering wheel**, with **steering wheel-mounted paddle shifters** that allow you to shift gears manually without using a clutch. This option is included in the 3 Series Sports Wagon when equipped with STEPTRONIC automatic transmission and Sport Package or M Sport Package.



■ **Three-spoke leather-wrapped multi-function steering wheel** lets you keep both hands on the wheel while adjusting various comfort functions, such as changing the radio, CD selections and volume. Optional Voice Command (included with optional Navigation system) can be used to access elements of the system.



■ **Engine Start/Stop button¹** and remote key control the engine. First, insert the remote key into the starter switch slot. After the electronic identification system confirms that it is the correct remote key, you can start (or later, turn off) the engine by pressing the Start/Stop button.

¹ Foot must be on brake in order to start; with manual transmission, clutch must also be depressed.



□ **Park Distance Control** uses ultrasonic sensors in the front and rear bumpers to help you judge the distance to other cars and unseen objects when parking. The beeping becomes faster as your bumper approaches the object, turning into a constant tone when the distance is less than 12 inches.



■ **Automatic climate control system** allows occupants to select a specific cabin temperature and choice of fan speeds, as well as automatic or manual airflow and recirculation. The automatic recirculation control activates whenever certain air pollutants are detected. The system also includes defrost/demist and MAX A/C functions.



■ **BMW anti-theft AM/FM stereo CD/MP3 player** includes Radio Data System, Auto-Store, and 3-channel FM diversity antenna; reads/displays song title.
■ **HD Radio™** receives free, digital AM/FM broadcasts in clear, static-free sound; multi-cast FM stations, and innovative data services.



■ **Dynamic Cruise Control** lets you set and keep to a chosen speed above 20 mph, automatically applying the brakes downhill. It is activated via the left-hand steering column switch, and deactivated by applying the brakes or via the switch.²

² Cruise Control systems are not a substitute for the driver's own responsibility in adjusting speed and otherwise controlling the vehicle. Due to road, traffic and visibility conditions, the driver must decide whether and how the system is used.

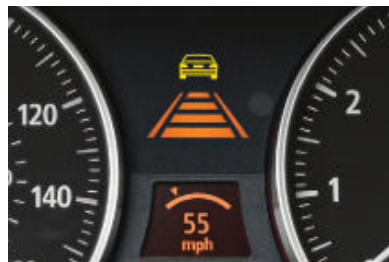

□ **Active Cruise Control** allows the driver to set a desired speed that is automatically maintained in free-flowing traffic. As a slower-moving vehicle is approached, a radar sensor alerts the system and adjusts speed to match the slower vehicle, while maintaining a preset following distance. As the lane ahead clears, the system automatically returns the car to the set speed.²



■ **Instrument panel** features a red backlit speedometer and tachometer. Centered between the two easy-to-read analog instruments is the on-board computer (see below center) with liquid crystal display providing additional important driving information.



□ **Logic7 Surround Sound anti-theft AM/FM stereo CD/MP3 player** audio system provides outstanding sound with 13 upgraded speakers, Digital Sound Processing (DSP), and an adjustable surround sound function. The subwoofer speakers, located under the front seats, produce an authentic bass sound.



■ **6-speed manual transmission** delivers a precise, athletic feel. Its responsiveness is due, in part, to the enhanced synchronization of shifts from neutral to each gear. A shortened shift lever and **throw** add to the sporty feel of the gearbox. The sixth gear drops revs at highway speeds for smooth cruising.



□ **6-speed STEPTRONIC automatic transmission** provides a choice of three modes: **Drive** with Adaptive Transmission Control; a more dynamic **Sport** mode; and STEPTRONIC automatic, for the hands-on control of a manual without a clutch.¹

¹ When ordered with Sport Package or M Sport Package, steering wheel-mounted paddle shifters are automatically included.



□ **Navigation system** features a high-resolution, glare-free monitor; a choice of detailed maps show **to** and **from** the directions to your desired destination. Enhancements include 3-D daytime and nighttime maps, zoom, travel planner, and an Assistance Window. Additionally the hard drive offers 12 GB of space that can hold up to 2,000 songs. It also provides Real Time Traffic Information on potential traffic problems and solutions.



■ **The on-board computer** with Check Control provides feedback on the vehicle's operating status: oil level indicator and distance to next service appointment/oil change, as well as other detailed information, such as spark plug and micro-filter status. It also provides travel information, including travel range on remaining fuel, external temperature, and more.



□ **Voice command** allows you to activate numerous Navigation system functions, record up to five minutes of notes, and make phone calls (if so equipped) hands-free. The Voice command button must be pressed before each use, so conversations won't accidentally activate the phone or other systems.



■ **Auxiliary input port** lets you connect an external audio source, such as an iPod® or MP3 player.
□ **iPod and USB adaptor** lets you scroll through and select the music you want by using the car's radio controls, the multi-function steering wheel buttons, or optional iDrive Controller. Music titles are displayed on the radio or Navigation screen.



■ **Standard front seats**, shown here with optional Dakota Leather upholstery, offer eight-way manual adjustment, including two-way headrests with Active Head Restraints feature. The front passenger seat also includes manual height adjustment.

Smoker's Package/ashtray (shown) not available.



□ **Heated front seats** are a welcome feature for driver and front passenger in cooler weather. By pressing the icon button, seat surface and backrest are heated and quickly radiate comfortable warmth in your choice of three settings. (Heated front seats are also included in the Cold Weather Package.)

For details on the availability of standard and optional features, please refer to the Standard equipment | Optional equipment charts at the back of this brochure.



□ **Power seat adjustments** included with eight-way power front seats allow customized comfort and convenience for driver and front passenger. The two-setting memory system automatically adjusts the driver's seat and side-view mirror positions, with individual preferences available at your fingertips.



■ **Power window buttons** with one-touch up/down operation and **exterior mirror adjustment** controls are located conveniently to the left of the driver, allowing access that doesn't require taking your eyes from the road.



■ **Front seatback storage nets** add secure, convenient storage for magazines, maps and small items.



■ **Front armrest** with integrated storage compartment folds up to allow access to a front cupholder and Auxiliary input port shown on the preceding page.



■ **Panoramic moonroof** features electric slide and lift control. When open, the wind deflector minimizes turbulence. Includes comfort opening/closing function, and a sliding interior sunshade to shield the cabin from excessive heat.



■ **Front cupholders** are integrated into the dashboard within convenient reach of the driver and front passenger. The passenger's cupholder is shown above; the driver's cupholder is to the right of the center console.



■ **Rear cupholders** are integrated into the front of the rear-seat center armrest. When not in use, they can be stored out of sight by sliding them back into the armrest.



□ **Comfort Access system** offers convenient keyless access to your car. Simply carrying the remote key in a pocket or purse allows you to unlock the doors by touching the door handle. You can also turn the engine on or off by pressing the Start/Stop button¹ without inserting the remote key.

¹Foot must be on the brake in order to start; with manual transmission, clutch must also be depressed.

Comfortable seating □ or more cargo room? Enjoy both with ease.

The versatile 3 Series Sports Wagon doesn't just offer space □ it offers endless possibilities. Open the tailgate and you'll immediately notice how much cargo room BMW has created, even above and to the sides. The 60/40 split-folding rear seats let you tailor its cargo- and passenger-carrying capabilities to fit your needs at any moment. Both seats fold down to create a large, lighted storage area; a handy power socket and side nets offer added practicality. Since run-flat tires are included as standard, there's no need for a spare wheel and tire. So BMW created an additional, hidden storage space under the cargo floor, complete with dividers and tool kit. The low tailgate load-in height makes handling

heavy or bulky items more manageable, and the rear window can be opened separately. A vertical luggage net helps keep the passenger and cargo areas separate □ an especially useful feature when the cargo shifts during short stops. A removable cover, which shields cargo from prying eyes, tilts up automatically when you open the rear window or tailgate. Standard roof rails and BMW's accessory roof rack system let you store more gear on top. The rear cargo area provides 24.8 cu. ft. of storage with the rear seats in the upright position; with rear seats folded down, the cargo area can be expanded to an impressive 58.0 cu. ft. of usable space.



■ **There's 24.8 cu. ft. of cargo space** □ even with three rear-seat passengers. Note the side storage nets and lashing eyelets designed to keep luggage immobile. Under the cargo floor, another storage space with dividers keeps items securely out of sight.

Please note: European model shown. Cargo mat not included.



■ **60/40 split-folding seatbacks** fold flat in varying combinations to accommodate rear-seat passengers as well as long cargo. When both seatbacks are folded down, cargo capacity expands to 58.0 cu. ft.



■ **Separately opening rear window** allows quick, easy access to the cargo compartment without having to lift the tailgate.



■ **Removable cargo cover** keeps your items safely hidden from view. **Retractable vertical luggage net** divides cargo and passenger areas, keeping pets, gear and groceries safely in back.



■ **Comfort-opening function** provides easy access to the cargo compartment by raising the cargo cover automatically whenever you open the rear window or tailgate.

Cold Weather Package

Enjoy winter to the fullest with the Cold Weather Package. A heated steering wheel helps keep your fingers comfortably warm and limber on chilly mornings, while quick-heating seats spread a welcome warmth. You'll appreciate the reassurance of clean, bright headlights on stormy nights. And for those en route to the slopes, a ski bag neatly holds skis and poles in place.



Retractable **high-intensity headlight washers** help keep lights clear of ice, mud, road salt and other coatings, for maximum road lighting and enhanced driving safety.



Heated steering wheel makes gloves unnecessary for cold weather driving. A flick of the switch quickly warms the steering wheel to the perfect temperature.



Heated front seats are a welcome feature for driver and front passenger in cooler weather. By pressing the icon button, seat surface and backrest are heated and quickly radiate comfortable warmth in your choice of three settings.



Ski bag allows clean and secure transport of up to four pairs of skis and ski poles. When the ski bag is not extended, the center armrest can be left down for use or folded up to create a third seat.

Premium Package

The Premium Package adds immeasurably to the enjoyment of your 3 Series Sports Wagon. Eight-way power-adjustable front seats, upholstered in supple Dakota Leather, offer the customized comfort of four-way lumbar support. At night you'll appreciate the enhanced visibility afforded by auto-dimming rear- and power-adjustable, folding exterior side-view mirrors. BMW Assist^{TM1} offers roadgoing peace of mind, while Bluetooth[®] wireless technology lets you keep in touch without taking your eyes from the road.² And the integrated three-button Universal garage-door opener takes the place of up to three separate remote-control devices, helping to eliminate clutter.

¹ See page 66 for detailed information on standard and optional services available with BMW Assist.
² Please contact your authorized BMW center for a list of BMW-approved Bluetooth technology enabled mobile phones.



Power-adjustable folding exterior side-view mirrors automatically dim when reflecting bright lights, helping to eliminate glare when driving at night.



BMW Universal garage-door opener takes the place of up to three remote-control devices. It can activate remote functions outside the vehicle, such as garage-door openers or home-lighting systems.



The **automatic-dimming inside rear-view mirror** darkens in response to the bright headlights of vehicles behind you. The easy-to-read **digital compass**, integrated into the mirror, is a convenient way to constantly keep your bearings while driving.

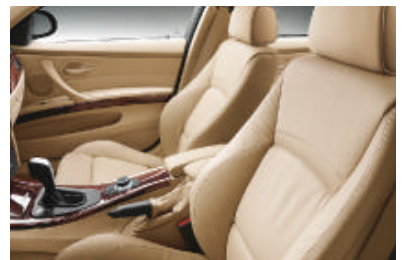

Eight-way power-adjustable front seats cradle driver and passengers in soft gathered Dakota Leather. Durable and easy to maintain, a Leather interior adds elegance and refinement.



Lumbar support for front seats adds four-way adjustable comfort for the lower back. Lumbar support can be adjusted up/down and in/out.



BMW Assist¹ and Bluetooth system offers hands-free calling through your BMW-approved Bluetooth phone.² The BMW Assist Safety Plan is included for four years, providing Automatic Collision Notification, Door Unlock, Emergency Request, Roadside Assistance, Stolen Vehicle Recovery, TeleService and more. The optional Convenience Plan offers Directions, Traffic, Weather, Critical Calling and Concierge services.

Sport Package

The Sport Package injects even greater excitement into every minute spent behind the three-spoke, leather-wrapped multi-function sport steering wheel.¹ Run-flat² performance tires³ and larger wheels team up with the sport-tuned suspension⁴ to grip corners with a vengeance. Specially bolstered sport seats cradle you comfortably over long distances, while holding you firmly in place during sporty driving maneuvers.



High-Gloss shadowline trim gives a purposeful look to window frames, window recess finishers, and door-sill trim strips.



Multi Spoke (Style 284) 17 x 8.0 light alloy wheels with 225/45 run-flat² all-season tires. (Included in 328i xDrive Sport Package.)



Star Spoke (Style 286) light alloy wheels with run-flat² performance tires.³ In front: 17 x 8.0 wheels with 225/45 tires; in back: 17 x 8.5 wheels with 255/40 tires. (Included in 328i Sport Package; optional in 328i xDrive with Sport Package.)



Three-spoke, leather-wrapped multi-function sport steering wheel lets you keep both hands on the wheel while changing the radio, CD selections and volume. Voice command (included with optional Navigation system) can be used to change radio stations and audio selection, Navigation system destinations, and (accessory) phone entries.



Eight-way adjustable front sport seats make the driving experience more enjoyable. Side bolsters can be power-adjusted to fit your back comfortably while helping to hold you firmly in place during cornering. (Eight-way power front sport seats with two-way manual headrests and thigh support require Premium Package or power seats feature.)

¹ When optional STEPTRONIC automatic transmission and Sport Package or M Sport Package are ordered, steering wheel-mounted paddle shifters are automatically included.

² Run-flat tires do not come equipped with a spare tire and wheel.

³ Due to low-profile tires, please note: wheels, tires and suspension parts are more susceptible to road hazard and consequential damages. Performance tires not recommended for driving in ice and snow.

⁴ Not available on 328i xDrive.

Smoker's Package/ashtray (shown) not available.

M Sport Package

An Aerodynamic kit and increased top-speed limiter hint at the performance-oriented attitude of the M Sport Package. Le Mans Blue Metallic, a paint choice exclusive to the M Sport Package, is set off by High-Gloss shadowline trim. The interior boasts sport seats, a leather-wrapped M multi-function sport steering wheel¹ and an Anthracite headliner. M door sills and an M footrest add an expressive visual touch. The M-tuned sports suspension⁴ is complemented by mixed size run-flat² performance tires.³ Available 18" Star Spoke (Style 193M) M light alloy wheels reduce unsprung weight.



Aerodynamic kit adds the sporty look of side skirts and an integrated rear spoiler.



Double Spoke (Style 194M) M light alloy wheels with run-flat² performance tires.³ In front: 17 x 8.0 wheels with 225/45 tires; in back: 17 x 8.5 wheels with 255/40 tires.



Three-spoke, leather-wrapped M multi-function sport steering wheel¹ is exclusive to the M Sport Package. It offers excellent grip, thanks to its thicker rim. The integrated multi-function buttons can be used to operate the radio, CD player and a Bluetooth[®] enabled mobile phone.



Sport front seats offer optimum lateral support during sporty driving maneuvers, and long-distance comfort when traveling. (Eight-way power front sport seats with two-way manual headrests and thigh support require Premium Package or power seats feature.)

Smoker's Package/ashtray (shown) not available.

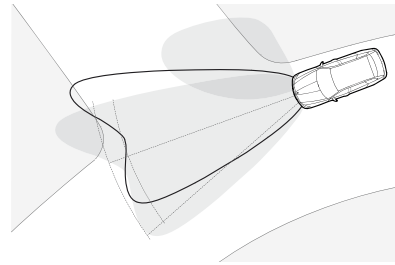

□ **Xenon Adaptive Headlights** automatically swivel to follow the curves of the road. The system uses data from on-board sensors and the steering wheel angle to determine the car's direction, then adjusts the headlights accordingly. The system offers outstanding nighttime vision.

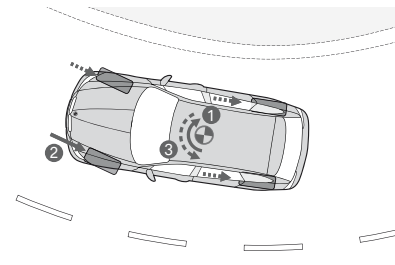

■ **Cornering Brake Control** increases vehicle stability by proportioning the braking force while turning. When you brake in a turn, the pressure comes off the rear wheels, which causes the vehicle to swerve inward (oversteer) (1). Cornering Brake Control counteracts this action by asymmetrically adjusting brake pressure (2), creating stabilizing counter-torque (3), independently of the ABS system.

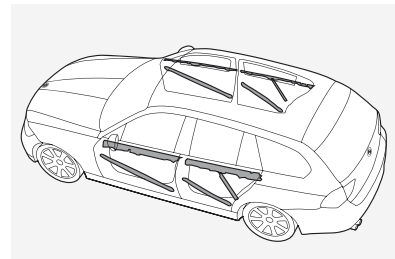

■ BMW's **door anchoring system** includes reinforcing bars with hook-like members within each door. In a serious side impact, the bars hook the door to the body, locking them together to make a more rigid passenger cell. When the pressure is released, the anchoring system is designed to disengage so that the doors can be opened (unless further damage from the impact prevents them from opening).

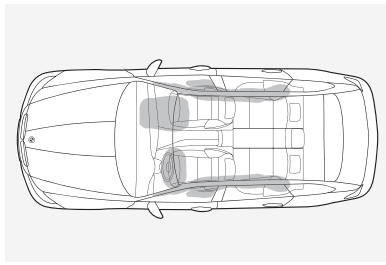

■ In the event of a collision, BMW's supplemental restraint system (SRS) with advanced technology for the driver and front passenger seats determines which **airbags** to deploy for optimal protection. The system also includes front seat-mounted side-impact airbags. BMW's **Head Protection System (HPS)** is designed to help protect passengers in both front and rear compartments.

Note: Pictures of airbags are for illustrative purposes only.



■ **BMW restraint system** for the driver and front passenger combines three-point safety belts, automatic safety-belt pretensioners, seat bolsters that help prevent occupants from sliding forward, and Active Head Restraints. This system helps provide optimum restraint in a collision.

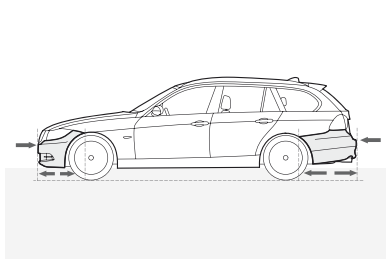

■ **Impact-absorbing bumpers** and compressible crush tubes front and rear help absorb the force of impact in collisions up to nine mph, minimizing damage to the vehicle's body and simplifying repairs. Only at higher impact speeds do structural supports begin to deform, dissipating impact energy to help protect occupants.

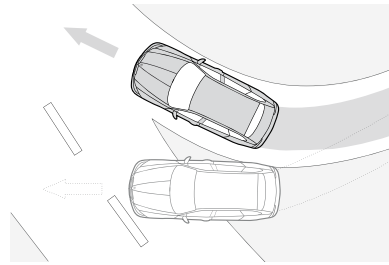

■ **Dynamic Stability Control (DSC) with Dynamic Traction Control (DTC)** features Brake Drying, Brake Stand-by, Brake Fade Compensation and Start-off Assistant. DSC is a braking control system that helps to stabilize a vehicle when it senses a loss of control. If the system senses over- or under-steer, it responds with counter-measures to help keep the vehicle under control.

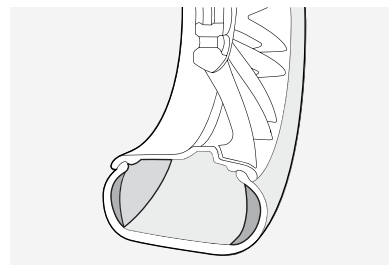

■ **Run-flat tires** allow speeds of up to 50 mph and travel from 30 to 150 miles after loss of air pressure, depending on the total vehicle weight.¹ Reinforced sidewalls help prevent the tires from collapsing or loosening from the rim. In the event of a decline in tire pressure, the driver is warned by the **Tire Pressure Monitor**.

¹ Please see the Owner's Manual for more information detailing allotted miles to travel and load weight rules.

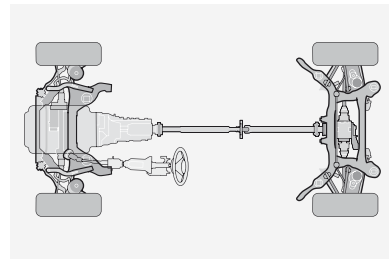

■ **Lightweight construction** is used throughout the 3 Series Sports Wagon. In both 328i and 328i xDrive, the five-link rear suspension includes cast-aluminum upper transverse arms. In the front section of the 328i, aluminum is used extensively for suspension components, including forged-aluminum lower arms and the steering knuckle, as well as the subframe and the steering rack.

	328i	328i xDrive
--	------	-------------

Performance and efficiency	328i	328i xDrive
3.0-liter, 230-horsepower, dual overhead cam (DOHC), inline 24-valve 6-cylinder engine with composite magnesium/aluminum engine block, Valvetronic, and Double-VANOS steplessly variable valve timing	●	●
Electronic throttle control	●	●
6-speed manual transmission	●	●
6-speed STEPTRONIC automatic transmission with Adaptive Transmission Control	○	○
Steering wheel-mounted paddle shifters (requires and is automatically included when STEPTRONIC automatic transmission and Sport Package or M Sport Package are ordered)	○	○

Handling, ride and braking	328i	328i xDrive
Dynamic Stability Control (DSC), including Brake Fade Compensation, Start-off Assistant, Brake Drying, and Brake Stand-by features, with Dynamic Traction Control (DTC)	●	●
xDrive all-wheel-drive system		●
Hill Descent Control		●
Double-pivot type front suspension	●	●
5-link rear suspension with cast-aluminum upper transverse arms	●	●
Extensive aluminum componentry, including front suspension components (forged-aluminum lower arms, steering knuckle); subframe; steering rack; and brake components (328i xDrive has steel lower arms and a steel subframe, plus an aluminum thrust plate)	●	
Front and rear anti-roll (stabilizer) bars	●	●
Twin-tube gas-pressure shock absorbers	●	●
4-wheel ventilated anti-lock disc brakes with Dynamic Brake Control (DBC)	●	●
Engine-speed-sensitive, variable-assist power steering	●	●
Sport suspension calibration	□/■	
Increased top-speed limiter (328i xDrive with Sports Package requires optional style 286 wheels with run-flat ¹ performance tires ²)	□/■	□/■

- Standard
- Optional
- Included in optional Sport Package
- Included in optional M Sport Package

¹ Run-flat tires do not come equipped with spare tire.

² Due to low-profile tires, please note: wheels, tires and suspension parts are more susceptible to road hazard and consequential damages. Performance tires are not recommended for driving in snow and ice.

	328i	328i xDrive
--	------	-------------

Exterior		
V Spoke (Style 360) 16 x 7.0 light alloy wheels, 205/55 run-flat ³ all-season tires	●	●
Multi Spoke (Style 284) 17 x 8.0 light alloy wheels, 225/45 run-flat ³ all-season tires		□
Star Spoke (Style 286) light alloy wheels, 17 x 8.0 front, 17 x 8.5 rear; 225/45 front, 255/40 rear run-flat ³ performance tires ⁴ (328i xDrive requires Sport Package)	□	○
V Spoke (Style 285) 17 x 8.0 light alloy wheels, 225/45 run-flat ³ all-season tires (cannot be ordered with Sport Package or M Sport Package)	○	○
Double Spoke (Style 194M) M light alloy wheels, 17 x 8.0 front, 17 x 8.5 rear; 225/45 front, 255/40 rear run-flat ³ performance tires ⁴	■	■
Star Spoke (Style 193M) M light alloy wheels, 18 x 8.0 front, 18 x 8.5 rear; 225/40 front, 255/35 rear run-flat ³ performance tires ⁴ (requires M Sport Package)	○	○
Tire Pressure Monitor	●	●
Halogen high- and low-beam headlights and Corona headlight-rings	●	●
Xenon Adaptive Headlights with dynamic auto-leveling and Corona headlight-rings	○	○
Halogen free-form front foglights	●	●
Retractable, high-intensity headlight washers	★	●
Heated dual power exterior mirrors and heated windshield washer jets	●	●
Roof rails	○	○
Chrome-plated exhaust tips	●	●
High-Gloss shadowline trim	□■	□■
Metallic paint	○	○

Interior seating and trim		
8-way adjustable front seats (includes 2-way headrests with Active Head Restraints feature)	●	●
8-way power front seats with 2-way manual headrests with Active Head Restraints feature, and driver memory with 2 presets for exterior mirror and seat positions	○◇	○◇
8-way manual adjustable front sport seats with adjustable back bolsters, and 2-way headrests with Active Head Restraints feature, and thigh support	□■	□■
8-way power front sport seats with adjustable back bolsters, 2-way manual headrests with Active Head Restraints feature, and thigh support; driver memory for exterior mirror and seat positions (requires power seats or Premium Package)	□■	□■
4-way adjustable power lumbar support for front seats	◇	◇
Split fold-down through-load rear seats	●	●
Leatherette upholstery	●	●
Dakota Leather upholstery	○◇	○◇
3-stage heated front seats	○★	○★
Front seatback storage nets	●	●
Ski bag	★	★
Dark Burl Walnut Wood trim	●	●
Light Burl Walnut Wood trim (no-cost option)	○	○
Aluminum trim (no-cost option)	○	○
Glacier Silver Aluminum trim (no-cost option; requires M Sport Package)	○	○
Anthracite headliner	■	■

- Standard
- Optional
- Included in optional Sport Package
- Included in optional M Sport Package
- ◇ Included in optional Premium Package
- ★ Included in optional Cold Weather Package

³ Run-flat tires do not come equipped with spare tire and wheel.

⁴ Due to low-profile tires, please note: wheels, tires and suspension parts are more susceptible to road hazard and consequential damages. Performance tires are not recommended for driving in snow and ice.

⁵ When equipped with power seats; optional and included in Premium Package.

	328i	328i xDrive
--	------	-------------

Comfort and convenience		
Engine Start/Stop button	●	●
Advanced Vehicle & Key Memory includes climate-control temperature and air-distribution settings, exterior mirror and power seat settings, ⁵ audio tone settings and radio presets with optional Navigation system, central-locking preferences, and lighting preferences	●	●
Comfort Access keyless entry with multi-function remote control	○	○
Automatic climate control includes micro-filter, automatic air recirculation, left/right temperature control, temperature- and volume-controlled rear outlets, windshield misting sensor, MAX A/C function, heat at rest, and recall of individual user settings	●	●
2-way power glass Panoramic moonroof with one-touch operation, sliding interior sunshade, and wind deflector	●	●
Front-seat center armrest	●	●
Front passenger cupholders (dashboard-integrated)	●	●
Rear-seat center armrest with cupholders	●	●
3-stage heated front seats	○★	○★
Heated steering wheel (not available with M Sport Package)	○★	○★
Tilt/telescopic steering wheel column	●	●
Park Distance Control (PDC), front and rear (M Sport Package does not include front PDC)	○■	○■
Automatic high beams	○	○
Interior and power-adjustable folding exterior mirrors with auto-dimming function; digital compass	◇	◇
Power front and rear windows with one-touch up/down operation	●	●
Rear manual side-window sunshades	○	○
Dynamic Cruise Control	●	●
Active Cruise Control	○	○
BMW Ambiance Lighting front and rear	●	●
Courtesy lights include fade in/fade out, actuation from remote, automatic switch-on when engine is turned off, separately controlled left/right front and rear reading lights, front footwell lighting, and illuminated vanity mirrors	●	●
Ground-illuminating lights in door handles	●	●
Locking glovebox	●	●
Luggage net	●	●
Electric interior tailgate release	●	●
Rain-sensing windshield wipers and Automatic headlight control	●	●
Integrated 3-button Universal garage-door opener	◇	◇

	328i	328i xDrive
--	------	-------------

Instrumentation and controls		
3-spoke leather-wrapped multi-function steering wheel with audio and Bluetooth® phone controls (if so equipped)	●	●
3-spoke leather-wrapped multi-function Sport steering wheel or M Sport steering wheel with audio and Bluetooth phone controls (if so equipped)	□/■	□/■
Service Interval Indicator with miles-to-service readout	●	●
Check Control vehicle monitor system with pictogram display, oil status display, and Condition Based Service indicator	●	●
On-board computer with Check Control ⓘ provides feedback on the vehicle's operating status: oil level indicator and distance to next service appointment/oil change, as well as other detailed information, such as spark plug and micro-filter status. It also provides travel information ⓘ travel range on remaining fuel, external temperature and more	●	●
BMW Navigation system with 16:9 high-resolution, 3-D screen, Voice Command system, and Real Time Traffic Information; iDrive system with high-function on-board computer, Controller, and 6 programmable memory keys; and 12 GB storage for audio files (also includes Online Information Services when equipped with BMW Assist™)	○	○

Audio system		
Anti-theft AM/FM stereo CD/MP3 player audio system with Radio Data System (RDS)	●	●
Logic7 Surround Sound anti-theft AM/FM stereo CD/MP3 player audio system with 13 upgraded speakers (including 2 subwoofers), Digital Sound Processing (DSP), Radio Data System (RDS), Auto-Store and 3-channel FM diversity antenna; displays MP3 song title and artist	○	○
Auxiliary audio input for portable music players	●	●
SIRIUS Satellite Radio with one-year subscription	○	○
iPod® and USB adaptor (includes cable connector)	○	○
Smartphone integration (requires iPod and USB adaptor and Premium Package or BMW Assist)	○	○
HD Radio™ with ⓘmulticast! FM station reception	●	●

Safety and security		
Anti-lock braking system (ABS)	●	●
Adaptive Brake Lights	●	●
BMW's Advanced Safety System for integrated deployment of passive and active safety features	●	●
Front and rear Head Protection System (HPS)	●	●
Active Head Restraints in front seats	●	●
Driver's and passenger's front airbag supplemental restraint system (SRS) with advanced technology: dual-threshold, dual-stage deployment; and front-passenger seat sensors designed to prevent unnecessary airbag deployment	●	●
Seat-mounted front side-impact airbags	●	●
Front safety belts with automatic pretensioners	●	●
Front passenger seat-occupation recognition with Passenger's Airbag Off indicator	●	●
Interlocking door anchoring system to help protect against door intrusion in side impacts	●	●
Central locking system with center console switch (leaves gas filler door unlocked), double-lock feature and 2-step unlocking	●	●
Coded Driveaway Protection	●	●

- Standard
- Optional
- Included in optional Sport Package
- Included in optional M Sport Package
- ◇ Included in optional Premium Package
- ★ Included in optional Cold Weather Package

	328i	328i xDrive
--	------	-------------

Safety and security (Continued)		
Automatic-locking retractors (ALR) on all passenger safety belts for installation of child-restraint seat	●	●
LATCH attachments on child-restraint safety installation	●	●
Impact sensor that activates Battery Safety Terminal disconnect of alternator, fuel pump and starter from battery; and automatically turns on hazard lights and interior lights, and unlocks doors	●	●
Anti-theft alarm system	○	○
Corona headlight-rings functioning as Daytime Running Lights	●	●
BMW Assist with Bluetooth® wireless technology for hands-free calling (with Bluetooth enabled mobile phone), with phonebook downloading and speech recognition capabilities (please visit your authorized BMW center for details on standard and optional services and a list of BMW-approved Bluetooth technology enabled mobile phones; also includes Online Information Services when equipped with BMW Navigation system)	○/◇	○/◇

BMW Services		
BMW Ultimate Service™ (for complete details on BMW Ultimate Service, visit bmwusa.com/ultimateservice)	●	●

Premium Package		
8-way power front seats with 2-way manual headrests with Active Head Restraints feature, and driver memory with 2 presets for exterior mirror and seat positions	○/◇	○/◇
4-way adjustable power lumbar support for front seats	◇	◇
Dakota Leather upholstery	○/◇	○/◇
Interior and power-adjustable folding exterior mirrors with automatic-dimming function; digital compass	◇	◇
Integrated 3-button Universal garage-door opener	◇	◇
BMW Assist with Bluetooth wireless technology for hands-free calling (with Bluetooth enabled mobile phone), with phonebook downloading and speech recognition capabilities (please visit your authorized BMW center for details on standard and optional services and a list of BMW-approved Bluetooth technology enabled mobile phones; also includes Online Information Services when equipped with BMW Navigation system)	○/◇	○/◇

Cold Weather Package		
3-stage heated front seats	○/★	○/★
Heated steering wheel	○/★	○/★
Ski bag	★	★
Retractable, high-intensity headlight washers	★	●

--	--	--

	328i	328i xDrive
--	------	-------------

Sport Package (not available with M Sport Package)		
Multi Spoke (Style 284) 17 x 8.0 light alloy wheels, 225/45 run-flat ⁶ all-season tires		☐
Star Spoke (Style 286) light alloy wheels, 17 x 8.0 front, 17 x 8.5 rear; 225/45 front, 255/40 rear run-flat ⁶ performance tires ⁷ (328i xDrive requires Sport Package)	☐	○
8-way manual adjustable front sport seats with adjustable back bolsters, and 2-way headrests with Active Head Restraints feature, and thigh support	☐	☐
8-way power front sport seats with adjustable back bolsters, 2-way manual headrests with Active Head Restraints feature, and thigh support; driver memory for exterior mirror and seat positions (requires power seats or Premium Package)	☐	☐
3-spoke leather-wrapped multi-function sport steering wheel with audio and Bluetooth [®] phone controls (if so equipped)	☐	☐
Sport suspension calibration	☐	
High-Gloss shadowline trim	☐	☐
Steering wheel-mounted paddle shifters (requires and is automatically included when STEPTRONIC automatic transmission and Sport Package is ordered)	○	○
Increased top-speed limiter (328i xDrive with Sport Package requires optional style 286 wheels with run-flat ⁶ performance tires ⁷)	☐	☐

M Sport Package (not available with Sport Package)		
Double Spoke (Style 194M) M light alloy wheels, 17 x 8.0 front, 17 x 8.5 rear; 225/45 front, 255/40 rear run-flat ⁶ performance tires ⁷	■	■
Star Spoke (Style 193M) M light alloy wheels, 18 x 8.0 front, 18 x 8.5 rear; 225/40 front, 255/35 rear run-flat ⁶ performance tires ⁷	○	○
8-way manual adjustable front sport seats with adjustable back bolsters, and 2-way headrests with Active Head Restraints feature, and thigh support	■	■
8-way power front sport seats with adjustable back bolsters, 2-way manual headrests with Active Head Restraints feature, and thigh support; driver memory for exterior mirror and seat positions (requires power seats or Premium Package)	■	■
3-spoke leather-wrapped multi-function M Sport steering wheel with audio and Bluetooth phone controls (if so equipped)	■	■
Park Distance Control (PDC), rear (M Sport Package does not include front PDC)	○/■	○/■
Sport suspension calibration	■	
Anthracite headliner	■	■
High-Gloss shadowline trim	■	■
Steering wheel-mounted paddle shifters (requires and is automatically included when STEPTRONIC automatic transmission and M Sport Package are ordered)	○	○
Increased top-speed limiter	■	■
Aerodynamic kit	■	■
M Sport Package	■	■

○ Optional
 ☐ Included in optional Sport Package
 ■ Included in optional M Sport Package

⁶Run-flat tires do not come equipped with spare tire and wheel.
⁷Due to low-profile tires, please note: wheels, tires and suspension parts are more susceptible to road hazard and consequential damages. Performance tires are not recommended for driving in snow and ice.

	328i	328i xDrive
--	------	-------------

Weight			
Unladen	lbs	3527 (3594)	3770 (3814)
Weight distribution, front/rear			
Manual transmission	%	48.4/51.6	50.9/49.1
Automatic transmission	%	48.8/51.2	51.2/48.8

Engine			
Liter/type		3.0 / inline 6	3.0 / inline 6
Bore/stroke	inch	3.35/3.46	3.35/3.46
Nominal output/rpm	hp	230/6500	230/6500
Maximum torque/rpm	lb-ft	200/2750	200/2750
Compression ratio	:1	10.7	10.7
Fuel grade		unleaded premium gasoline	unleaded premium gasoline

Transmission			
Manual gear ratios			
III	:1	4.32/2.46	4.35/2.50
III/IV	:1	1.66/1.23	1.67/1.23
V/VI/R	:1	1.00/0.85/3.94	1.00/0.85/3.93
Final drive ratio	:1	3.23	3.38
Automatic gear ratios			
III	:1	4.07/2.37	4.07/2.37
III/IV	:1	1.55/1.20	1.55/1.20
V/VI/R	:1	0.85/0.67/3.20	0.85/0.67/3.20
Final drive ratio	:1	3.73	3.91

Performance			
Drag coefficient	C _d	0.30	0.31
Top speed ¹	mph	130 [150]	130 [148 ²] ([147 ²])
Acceleration 0-60 mph ³			
Manual transmission	sec	6.5	7.1
Automatic transmission	sec	7.1	7.3

Fuel consumption⁴			
Manual transmission City/Highway	mpg	17/27	17/25
Automatic transmission City/Highway	mpg	18/27	17/25
Approximate tank capacity	gal	16.1	16.1

Figures in () apply to vehicles with automatic transmission.
 Figures in [] apply to vehicles with Sport Package or M Sport Package.

¹ Top speed limited electronically.
² Requires optional Star Spoke (Style 286) light alloy wheels and run-flat performance tires.
³ BMW AG test results. Actual acceleration results may vary, depending on specification of vehicle; road and environmental conditions; testing procedures and driving style. These results should be used for comparison only and verification should not be attempted on public roads. **BMW urges you to obey all posted speed laws and always wear safety belts.**
⁴ EPA-estimated figures are for comparison purposes only. Your actual mileage will vary, depending on speed, driving habits, trip length and driving conditions; actual mileage may be lower.

		328i	328i xDrive
--	--	------	-------------

Tires and wheels			
Tire dimensions	standard	205/55	205/55
Wheel dimensions	standard	16 x 7.0	16 x 7.0
Material	standard	light alloy	light alloy

Brakes			
Front \varnothing diameter	inch	12.3	12.3
Rear \varnothing diameter	inch	11.8	11.8

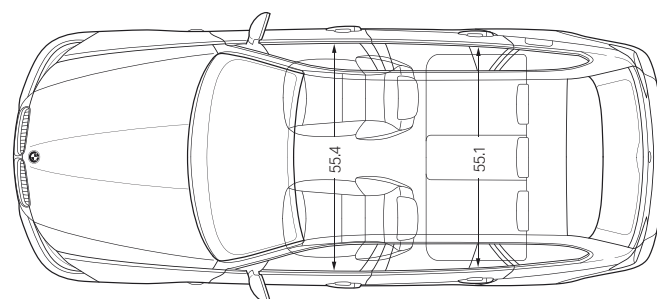
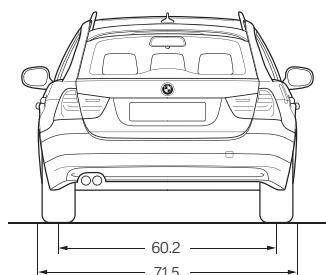
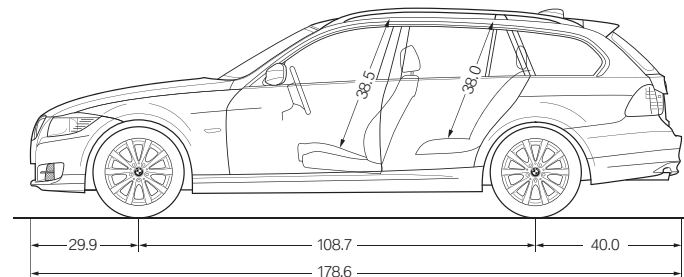
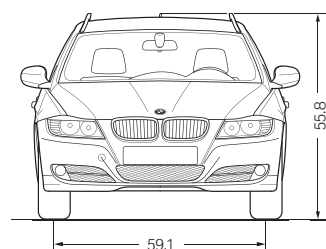

All dimensions are shown in inches.

U.S. Importer: BMW of North America, LLC, Woodcliff Lake, NJ 07677. All illustrations and specifications contained in this brochure are based on the latest product information available at the time of printing. BMW reserves the right to make changes at any time, without notice, in colors, materials, equipment, specifications and models. BMW may, subject to legal requirements, determine the Model Year designation of its vehicles. The Model Year designation on any particular model may be longer or shorter than 12 months. Some vehicles pictured

may contain non-U.S. equipment. Some models may be shown with optional equipment. While BMW NA makes diligent efforts to provide accurate information in this brochure, there is no guarantee or warranty of accuracy. Furthermore, we do not assume any liability for the accuracy or completeness of information presented. This brochure shall not be used or relied upon as a substitute for information that is available from your BMW center. Further information can be obtained from your authorized BMW center or bmwusa.com.

©2009 BMW of North America, LLC. Not to be reproduced wholly or in part without written permission of BMW NA. The BMW name, model names and logo are registered trademarks. The Bluetooth word mark and logos are owned by the Bluetooth SIG, Inc. and any use of such marks by BMW is under license. iPod is a registered trademark of Apple Inc. Other trademarks and trade names are the property of their respective owners.

Equipped with the best ideas.
Original BMW Accessories.



BMW Roof Box 460, and 19" Star Spoke (Style 199) light alloy wheels.

Driving a BMW is always a special experience and it can be further enhanced with Original BMW Accessories. Benefit from innovative solutions that combine striking design and inspired functionality. BMW Accessories are available in many categories: exterior, interior, mobile communications, transportation and storage. Each is designed and manufactured to meet the same demanding quality standards as your BMW.

To find out more about these and other accessories, contact your preferred authorized BMW center. There you will find a wide selection of quality items, as well as a special brochure detailing the entire range of Original BMW Accessories to fit your 3 Series Sports Wagon. Or visit our website at accessories.bmwusa.com to view the full selection.



Lockable bicycle holder for trailer tow hitch transports up to three bicycles.





Snap-in adapter enables hands-free phone calls and charges the phone.



BMW Portable DVD System plays video DVDs, games, and picture CDs.

BMW European Delivery: Save money and drive your new BMW on the roads it was designed for.

The new **BMW Welt** ( BMW World ) delivery and brand-experience center in Munich is bold proof of BMW's passion for design. When you take advantage of the BMW European Delivery Program,¹ this is where you will meet your new BMW  in a personalized process that is highly dramatic and totally unforgettable. (You might also realize substantial savings that just may pay for your trip.) While you're there, marvel at the historic BMWs in the Museum; learn about our engineers' newest innovations in the Technology and Design Atelier; and take a tour of the plant to experience firsthand the state-of-the-art methods used to create a BMW. Then comes the unique experience of driving your new BMW on the roads it was designed for. To learn more, visit bmwusa.com/europeandelivery.





BMW Ultimate Service.™

At BMW, we believe that a premium ownership experience should feature performance and luxury, as well as safety and convenience. We believe you should be able to drive a BMW to its potential, while enjoying peace of mind and reduced cost of ownership. That's the idea behind BMW Ultimate Service: a suite of comprehensive programs and services that are included in every 2009 and later model year vehicle. The New Vehicle Limited Warranty, the BMW Maintenance Program, and Roadside Assistance come standard, with BMW Assist™ offered as an option. BMW Ultimate Service starts with the **New Vehicle Limited Warranty**, providing you with coverage for the first four years or 50,000 miles, whichever comes first. Additionally, you have 12-year, unlimited-mileage warranty protection against corrosion and rust perforation.² **BMW Maintenance Program** is one of the most comprehensive maintenance programs in its class. We cover all factory-recommended maintenance during the New Vehicle Limited Warranty coverage period. This includes scheduled oil services and inspections. Also covered is the replacement of items that are subject to normal wear and tear, such as brake pads, wiper blade inserts and engine drive belts.³ And, thanks to BMW's advanced engineering, most owners enjoy a well-balanced maintenance schedule, with flexible routine service intervals that can save you time. When your vehicle requires attention, your authorized BMW or BMW SAV® center ensures that it receives only genuine BMW parts  your assurance of exacting quality standards.





BMW Roadside Assistance is provided free of charge for the first four years  with no mileage limit. Call **1-800-332-4BMW (4269)** for friendly on-the-road help, 24/7, anywhere in the United States, Canada and Puerto Rico. This includes everything from flat-tire changes, emergency gasoline and lock-out service, to towing, alternative transportation and even trip-interruption benefits. This service also provides valuable trip-routing advice.

The **BMW Assist™** Safety Plan⁴ is an optional four-year program. You'll enjoy peace of mind knowing that a friendly response specialist is there to help you, 24/7, at just the push of a button. The Safety Plan includes Automatic Collision Notification, Emergency Request, Enhanced Roadside Assistance, Door Unlock, Stolen Vehicle Recovery and Customer Relations. MyInfo allows you to send business locations and street addresses with their associated phone numbers from the Google Maps™ website directly to your BMW. The destination can be sent to your Navigation system for turn-by-turn directions, and you can call the destination via your Bluetooth® linked cell phone. And for the ultimate in coverage, add the optional **Convenience Plan**.⁵ You'll enjoy unlimited access to personalized Directions, Traffic and Weather reports, as well as our Concierge feature, which can send a destination address and phone number, such as a restaurant or hotel, right to your BMW. You can make up to four operator-assisted calls per year with Critical Calling if your cell phone is not available, or if its battery is discharged. BMW Search allows online access to up-to-date fuel prices and the latest weather forecasts, as well as Bloomberg's stock indices and the powerful reach of the Google Maps database  delivered to the iDrive display right inside your vehicle.





BMW's unique **TeleService**, included in the BMW Assist Safety Plan, continually monitors specific parts that are subject to wear and tear  including the engine oil, micro-filter, spark plugs, brake linings and various fluids  as well as services that require attention at regular intervals, such as vehicle service inspections. This data is automatically transmitted to your BMW center, which will then call you to schedule a service appointment. You don't have to keep track of when your vehicle requires routine maintenance. An added benefit: any needed maintenance service parts will already be on hand, so your BMW is serviced and returned to you as quickly as possible.

For more details on BMW Ultimate Service, visit your preferred BMW or BMW SAV center or log on to bmwusa.com/ultimateservice.

BMW Virtual Center.

If you get the sudden urge to shop for a BMW but your BMW center is closed, there's good news  the BMW Virtual Center is open 24 hours a day! Log on to bmwusa.com, then click on the model series you are interested in. After selecting the BMW that interests you, click on  Build Your Own  Configure the BMW of your dreams, and see what the monthly payments would be. You can even send the specifications to your authorized BMW center, apply for financing, or request a test drive  all online!

BMW Financial Services.

Arranging to buy or lease a BMW is easier than you may think. Your authorized BMW SAV center offers leasing and financing to suit your personal needs through BMW Financial Services.⁶ Start the process at our website, where you can build your  dream vehicle  get an estimate on a monthly lease or financing payment, submit a credit application to BMW Financial Services  and get approval  all online!⁶ To find out how BMW Financial Services can help put you behind the wheel of your favorite BMW model, log on to bmwusa.com/fs or call, toll-free, **1-800-578-5000**.

BMW Publications and Media Gallery.

Sent to new owners and lessees several times a year, **BMW Magazine** is a fascinating view of the latest events and products in the world of BMW, including personality profiles, travel reviews, and the latest BMW technologies. You can read articles from **BMW Magazine**, as well as **Mdriver** and **Inside Track**, on the BMW website at bmwusa.com in the Media Gallery/News Feed, found in the Experience section. Here you can also view featured videos and images, read recent news articles, and download BMW wallpapers. For more information, call Customer Assistance at **1-800-334-4BMW (4269)** or visit BMW online at bmwusa.com.

¹ Not all models available for BMW European Delivery Program. Please go to bmwusa.com or visit your authorized BMW center for details.

² See your authorized BMW center for details on these limited warranties.

³ The BMW Maintenance Program covers factory-recommended maintenance services as determined by the Service Interval Indicator for all new eligible MY 2004 and later BMW vehicles. Specific additional items that need replacement due to normal wear and tear are also covered. The maintenance coverage period is for the first 4 years or 50,000 miles, whichever comes first. Exclusions from coverage include: gasoline, gasoline additives, windshield washer fluid and additives, tires, wheels, wheel alignment and tire balancing. All work must be performed by an authorized BMW center. See the Service and Warranty Information booklet for specific terms, conditions and limitations. Further information can also be obtained from your authorized BMW center.

⁴ The BMW Assist and Bluetooth Hands-free Calling system with 4 years of Safety Plan services is optional or included in the Premium Package. In order to receive BMW Assist services, a subscriber agreement must be completed and transferred to the BMW Assist Response Center. GPS and underlying wireless services must be available and functioning; vehicle ignition must be turned on (except for Door Unlock and Stolen Vehicle recovery), battery charged and connected and vehicle's electrical system operational; services may be limited to certain geographic areas. Call toll-free **1-888-333-6118**, log on to bmwassist.com, or visit your BMW center for additional program details. Services are subject to the terms and conditions of your subscriber agreement.

⁵ Requires BMW Assist Safety Plan subscription. Services are subject to the terms and conditions of your subscriber agreement. Please go to bmwassist.com for additional details on the optional Convenience Plan.

⁶ Subject to credit approval and other terms and conditions.

More about BMW

bmwusa.com
1-800-334-4BMW



The Ultimate
Driving Machine®

BMW and the environment.

BMW is a strong proponent of the environment and social responsibility. It is important to manage the earth's resources responsibly, and not jeopardize the needs of future generations. That is why BMW makes vehicles that minimize adverse environmental impact, from production (pollution prevention and waste minimization at the plant) through owner use (low emissions) to eventual disposal (easy drainability of all fluid-related components and easy neutralization of all pyrotechnic devices).

This effort has been recognized worldwide and, as a result, we are pleased to have received numerous environmental honors. In the U.S., for example, the Environmental Protection Agency accepted BMW's Spartanburg, SC production and manufacturing facility as a charter member of the agency's National Environmental Performance Track. Internationally, BMW AG – the parent company of both BMW of North America and BMW Manufacturing Co., Spartanburg, SC – was the first automotive company to be represented on the Dow Jones Sustainability Group Index, and has remained on the Index ever since. At BMW, we strive for high performance in everything we do.

BMW recommends 

